



*Il Loft*

DELTA COLLECTION

DELTA COLLECTION *Il Loft*

## UN CREATIVO

Da bambino, ammirava i colori, suoni e sapori della natura. Da adulto, le opere dei grandi architetti: da Gio Ponti e Marco Zanuso a Frank Lloyd Wright, Mies van der Rohe e Oscar Niemeyer.

La ricerca del Bello, in tutte le sue forme, è quello che anima da sempre Giorgio Saporiti. Architetto e designer innamorato del colore ("senza di esso la vita non esiste") ma anche imprenditore e grande conoscitore di tendenze del design e della moda, Giorgio Saporiti è stato definito un'"inesauribile macchina sforna-idee": il suo mondo di tessuti, arredi, complementi e interior sembra infatti rigenerarsi all'infinito, dando vita a creazioni che sono allo stesso tempo di tendenza e evergreen. Le sue forme razionali e pulite ma capaci di emozionare, le sue cromie che si fondono le une con le altre, i suoi accostamenti spesso azzardati ma sempre capaci di creare un'armonia perfetta sono alla base del successo globale de Il Loft, l'azienda da lui creata nel 1994, il cui marchio è riconosciuto in tutto il mondo come araldo della qualità Made in Italy.

La sua ricetta per il successo? "Progettare perché non solo ogni arredo o complemento ma anche ogni spazio sia unico, pensato per il committente a sua immagine e somiglianza. Perché un interior riuscito è uno in cui si è felici di vivere".

"L'ineluttabile ciclo della trasformazione interessa la nostra casa e il mondo attorno a noi. Nell'atto di creazione una cosa mi resta sempre impressa nella mente: occorre raggiungere la perfetta unione con l'interno che costantemente si rinnova".

## A CREATIVE MIND

*When he was a little kid, he used to wonder at the colors, sounds and flavors of nature. As an adult, he was stunned by the masterpieces of great architects such as Gio Ponti and Marco Zanuso, or Frank Lloyd Wright, Mies van der Rohe and Oscar Niemeyer.*

*The search for Beauty, in all its forms, is what has always motivated Giorgio Saporiti. As an architect and a designer, he is in love with colors ("without them, there is no life"); but his multifaceted nature made it possible for him to be, at the same time, also an excellent entrepreneur as well as a living antenna for design and fashion trends. It does not come as a surprise, then, to hear that Giorgio Saporiti is considered by those who know him "an unstoppable ideas generating machine". His world of fabrics, furniture, and interiors actually seems to regenerate itself infinitely and to give life to creations that have the amazing capacity to be at the same time trendy but evergreen. His rational, pure lines are able to bring out emotions, his color palettes mingle one with the other, his couplings are often hazardous but always end up providing a perfect harmony. These are the characteristics that made up the success of the company that Giorgio Saporiti himself created in 1994, Il Loft, a brand that is now universally recognized as a herald of Made in Italy quality.*

*His recipe for success? "Designing so that all furniture and interior is a reflection of the client's taste and soul. So that he or she is happy to live in it".*

*"The unavoidable cycle of transformation also challenges our ideas of home. When I create something, I always keep this in mind: interiors will have to be in tune with the ever-changing world around us".*

GIORGIO SAPORITI



## DELTA COLLECTION

Design 100% italiano e materiali esclusivi, sono questi i leit-motiv ricorrenti in ogni singolo progetto firmato Il Loft: tessuti, arredi, complementi e interior dalle forme pulite e razionali, sempre capaci di stupire ed emozionare. Un modo di fare design unico che ha portato l'azienda ad essere emblema della qualità made in Italy nel mondo. A garanzia della progettazione ricercata ed accurata dell'azienda c'è la mente creativa di Giorgio Saporiti, maestro del design e della moda capace di reinterpretare le tendenze del momento in una chiave ironica e raffinata. La ricerca della Qualità e di materiali e finiture esclusive stanno alla base della nuova collaborazione tra Giorgio Saporiti e lo studio Castello Lagravinese, che ha portato alla realizzazione di una collezione di chiara ispirazione sartoriale. Nuovi prodotti dal design innovativo e con cromie ricercate saranno presentati in esclusiva al Salone del Mobile di Milano, per inserirsi perfettamente nella più ampia collezione esistente de Il Loft.

*100% Italian design and exclusive materials form the leitmotifs of every single Il Loft project: fabrics, furniture, furnishings and interiors with clean, functional lines that never fail to amaze and kindle emotions. This unique approach to design has transformed Il Loft into an internationally recognised symbol of the best of "Made in Italy" quality. Guaranteeing the company's sophisticated and meticulously crafted designs is the creative genius of Giorgio Saporiti, a past master at design and fashion who has a flair for interpreting the latest trends with refinement and a tasteful touch of humour. The quest to achieve only the finest quality and use exclusive materials and finishings represents the cornerstone of the new collaboration between Giorgio Saporiti and the Castello Lagravinese Studio, which has given rise to a collection with palpable sartorial inspiration. The new innovatively designed products in refined tones will be exclusively unveiled at the International Furniture Fair in Milan, and represent the perfect addition to Il Loft's wider existing collection.*

DESIGN: Castello - Lagravinese









## DELTA

Un nuovo sistema di sedute dalle forme arrotondate con i piedini interamente rivestiti in tessuto, il divano Delta è disponibile in versione lineare, angolare e sagomata. Questa serie di divani consente la realizzazione di composizioni insolite e inaspettate, capaci di arredare lo spazio combinando geometrie molto diverse tra loro.

La versione sagomata in particolare, è realizzata con uno schienale a doppia altezza flessibile, che consente di creare degli spazi privati avvolgenti, suddivisi da zone di appoggio inaspettate. Un design trasformabile e personalizzabile che segue le esigenze della casa flessibile contemporanea.

*A new seating system with rounded forms and fully upholstered feet. The Delta sofa is available in a linear, corner and shaped version. With this series of sofas you can create unusual and surprising compositions that stylishly furnish the space by combining highly dissimilar geometric forms. The shaped version is particularly striking with its double-height back that enables you to create snug, private spaces divided by unexpected armrest areas. An adaptable, customisable design that meets the demands of today's flexible homes.*

DESIGN: Castello - Lagravinese

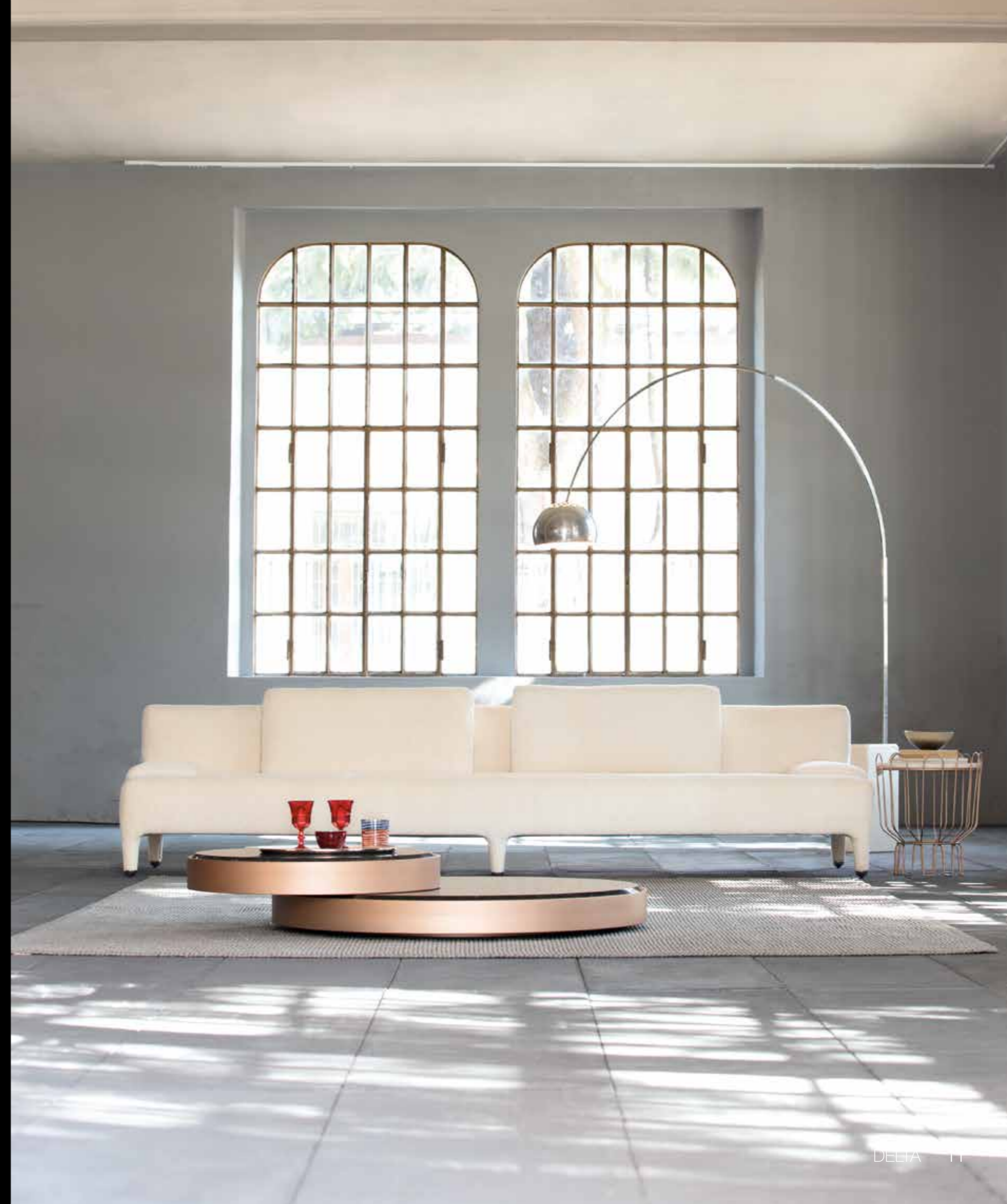

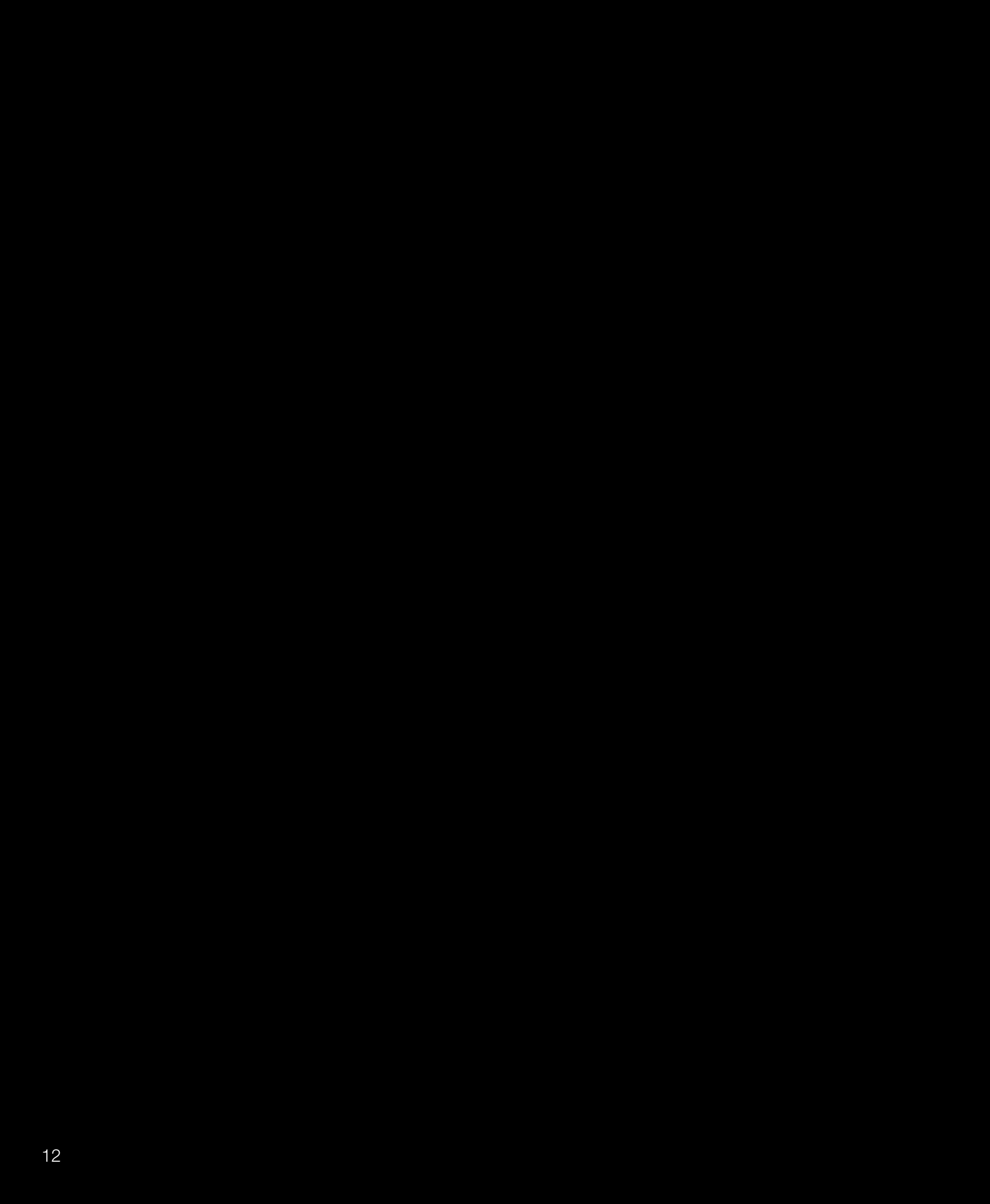



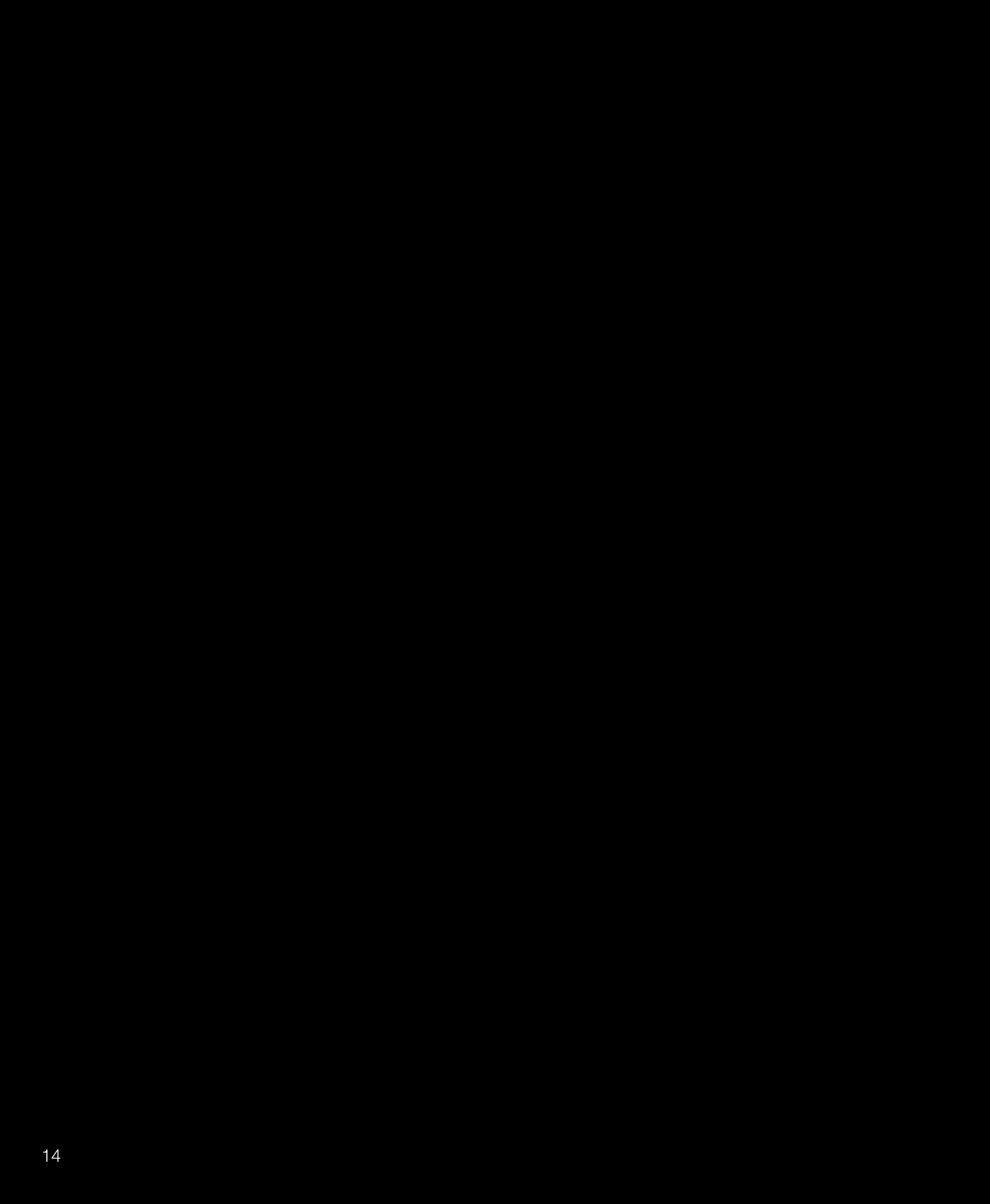





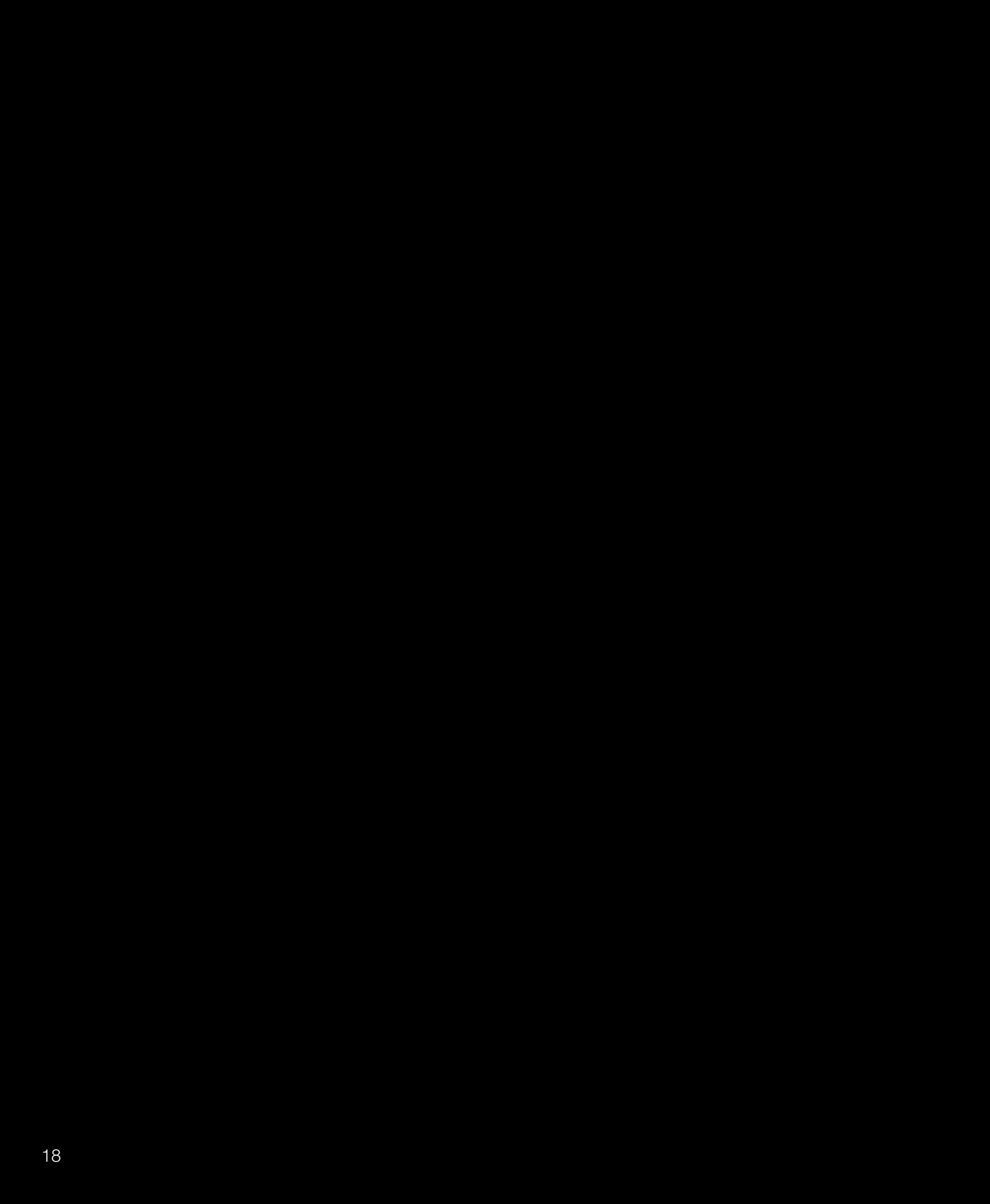

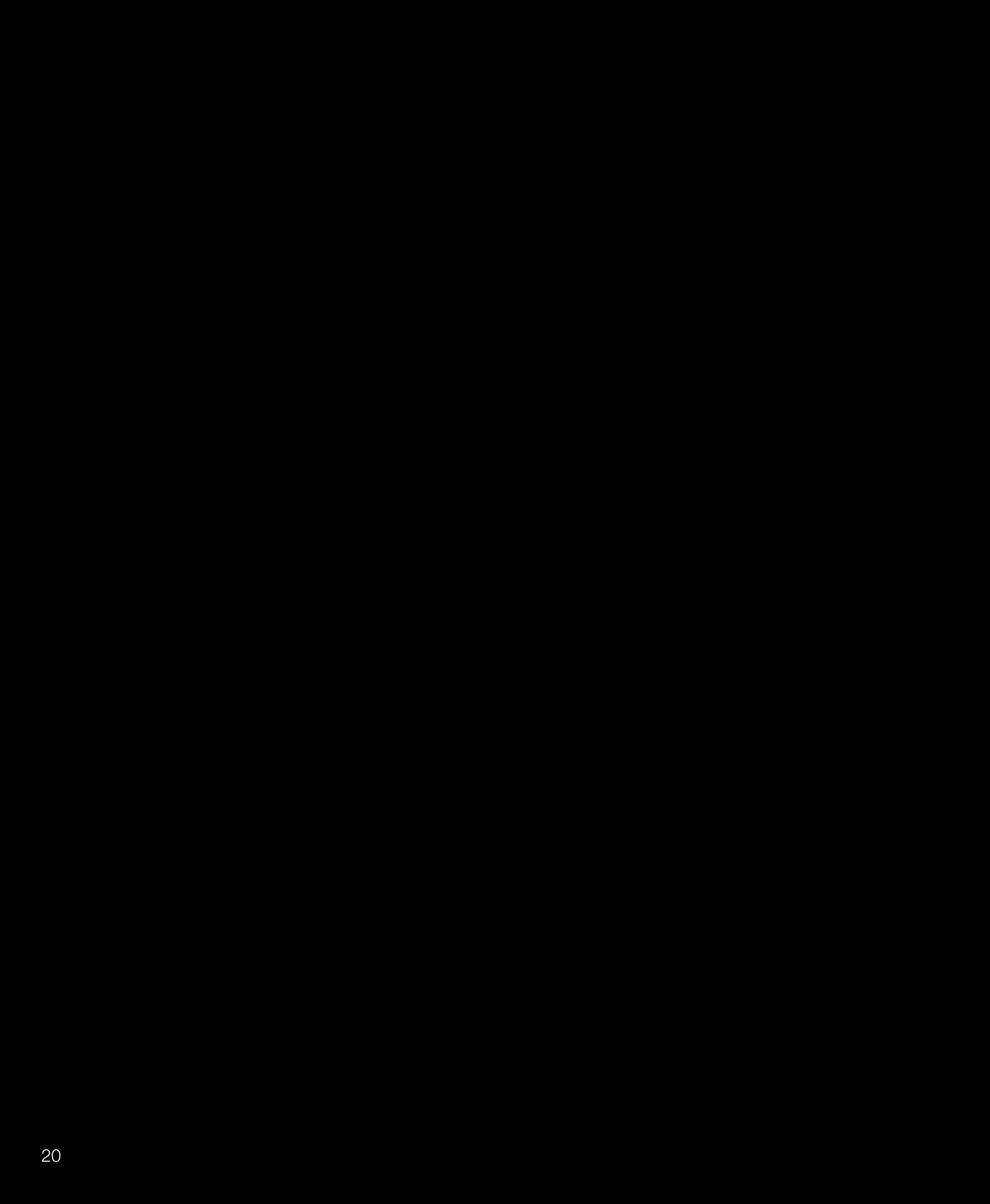







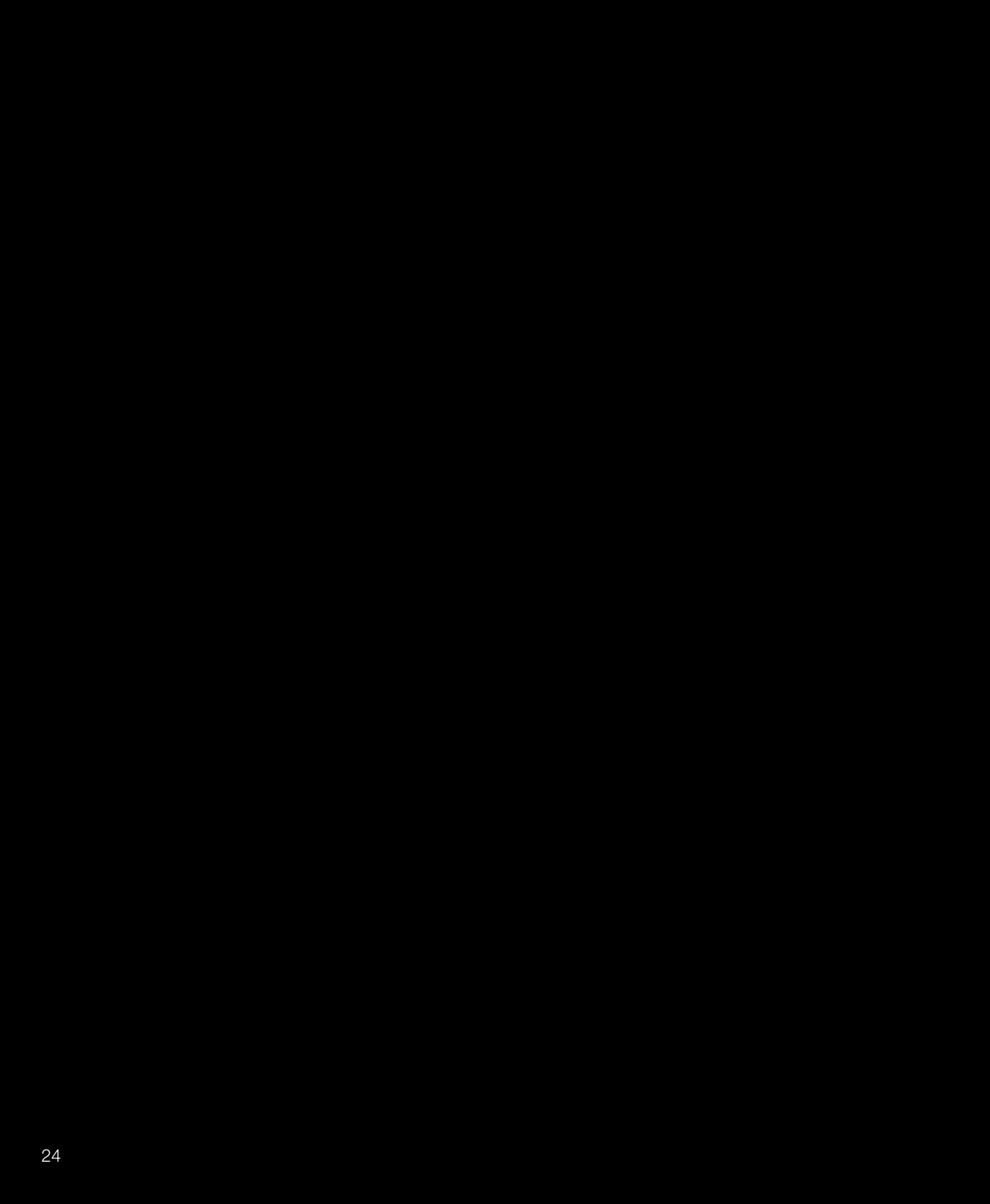











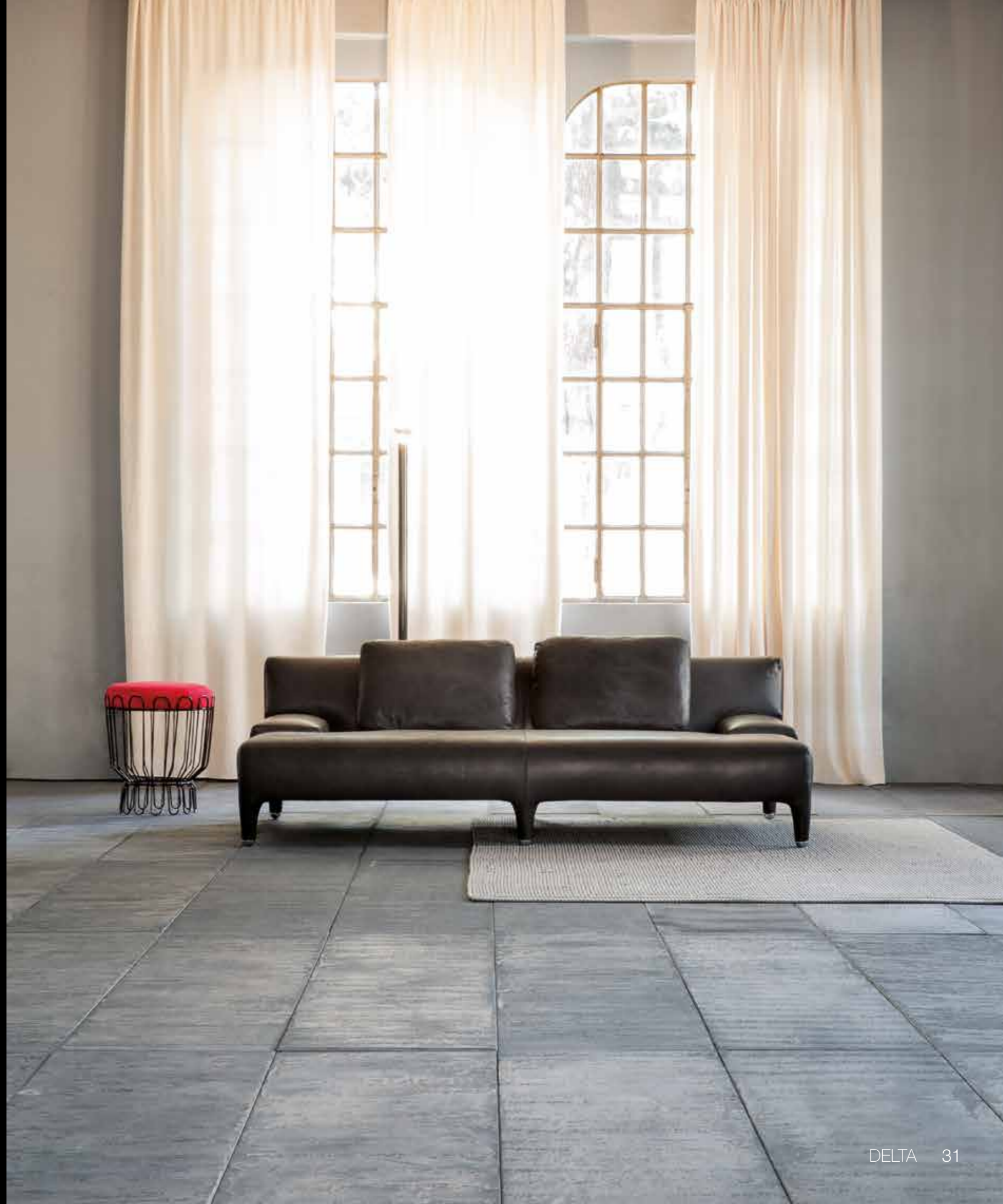
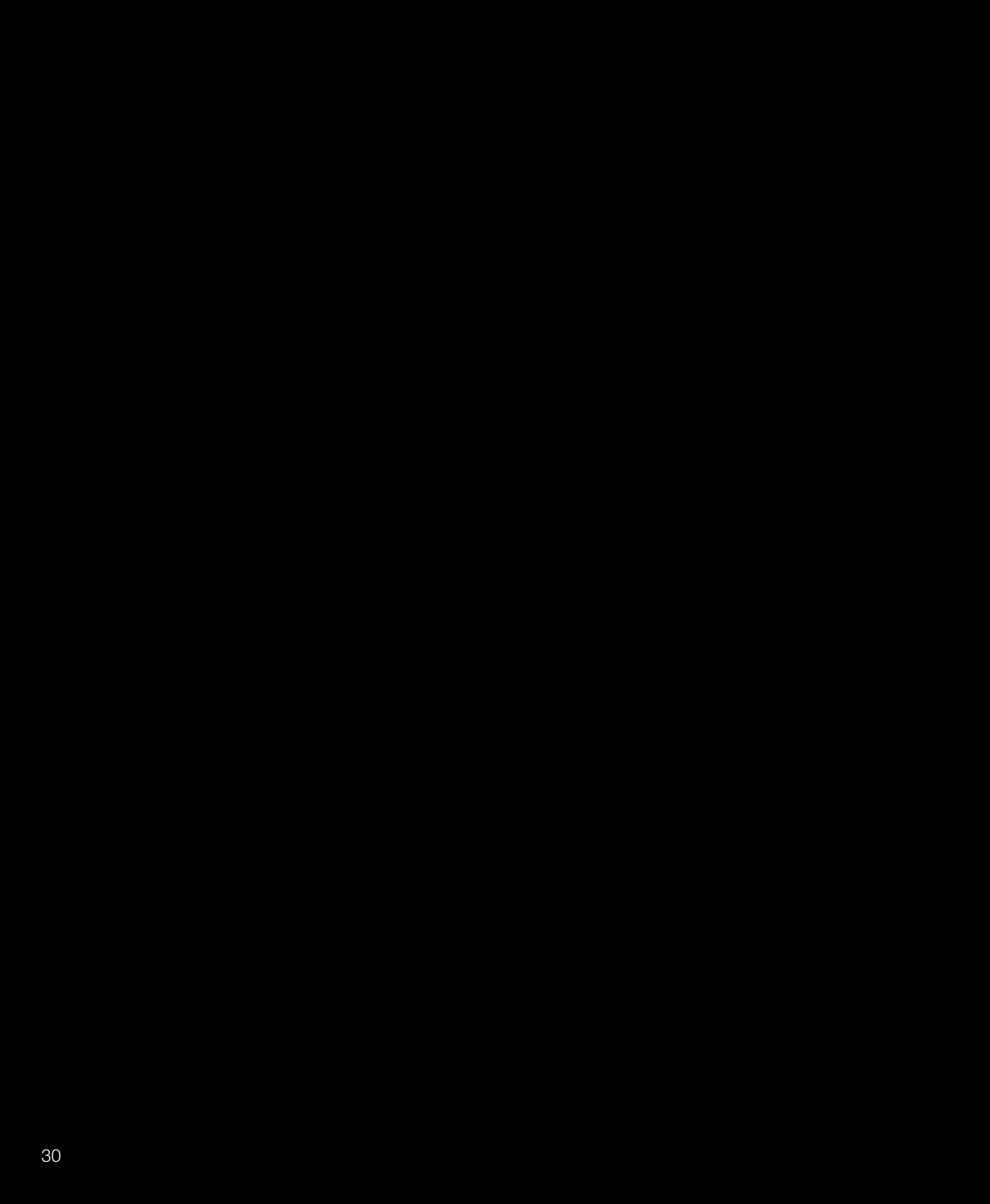





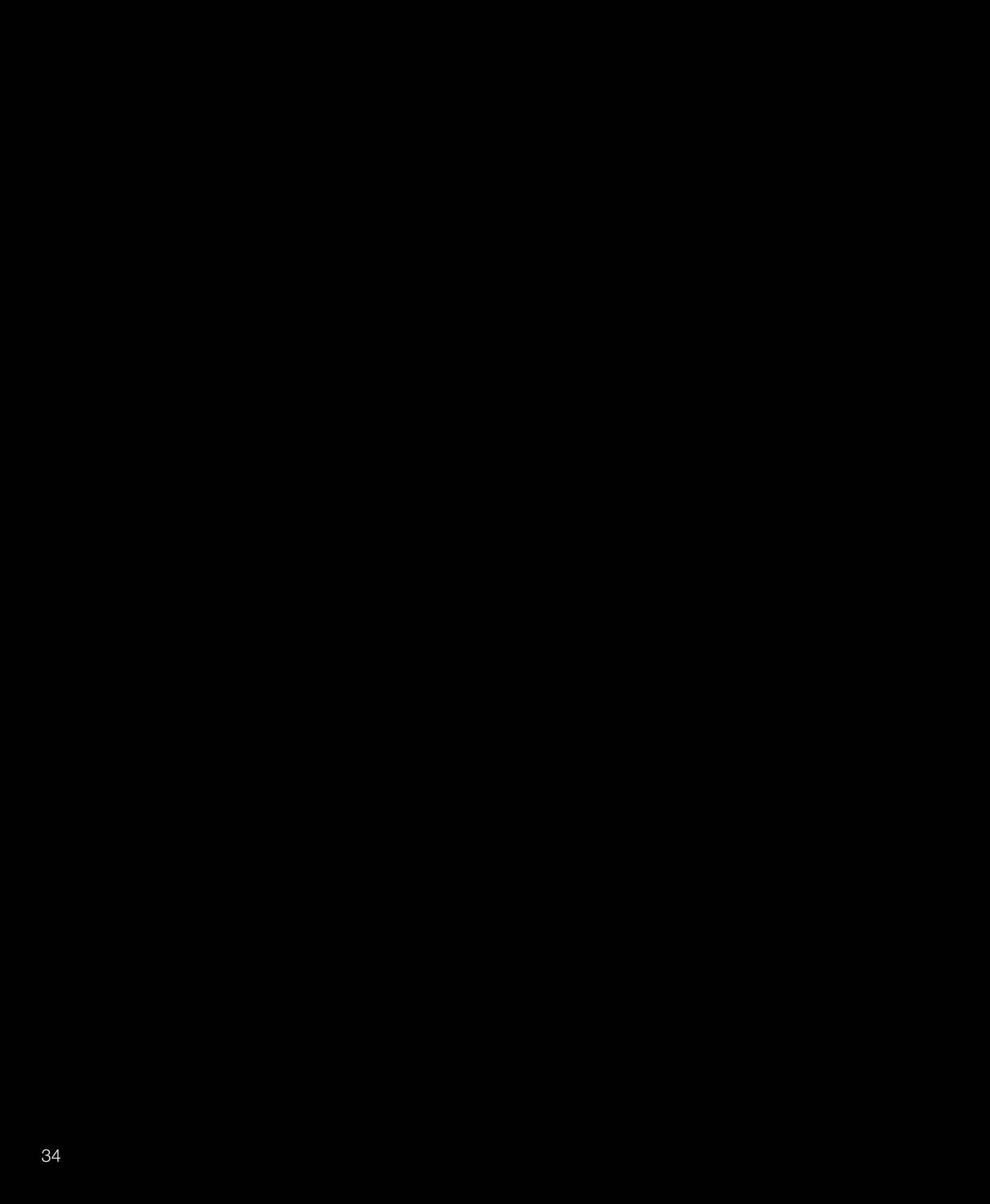































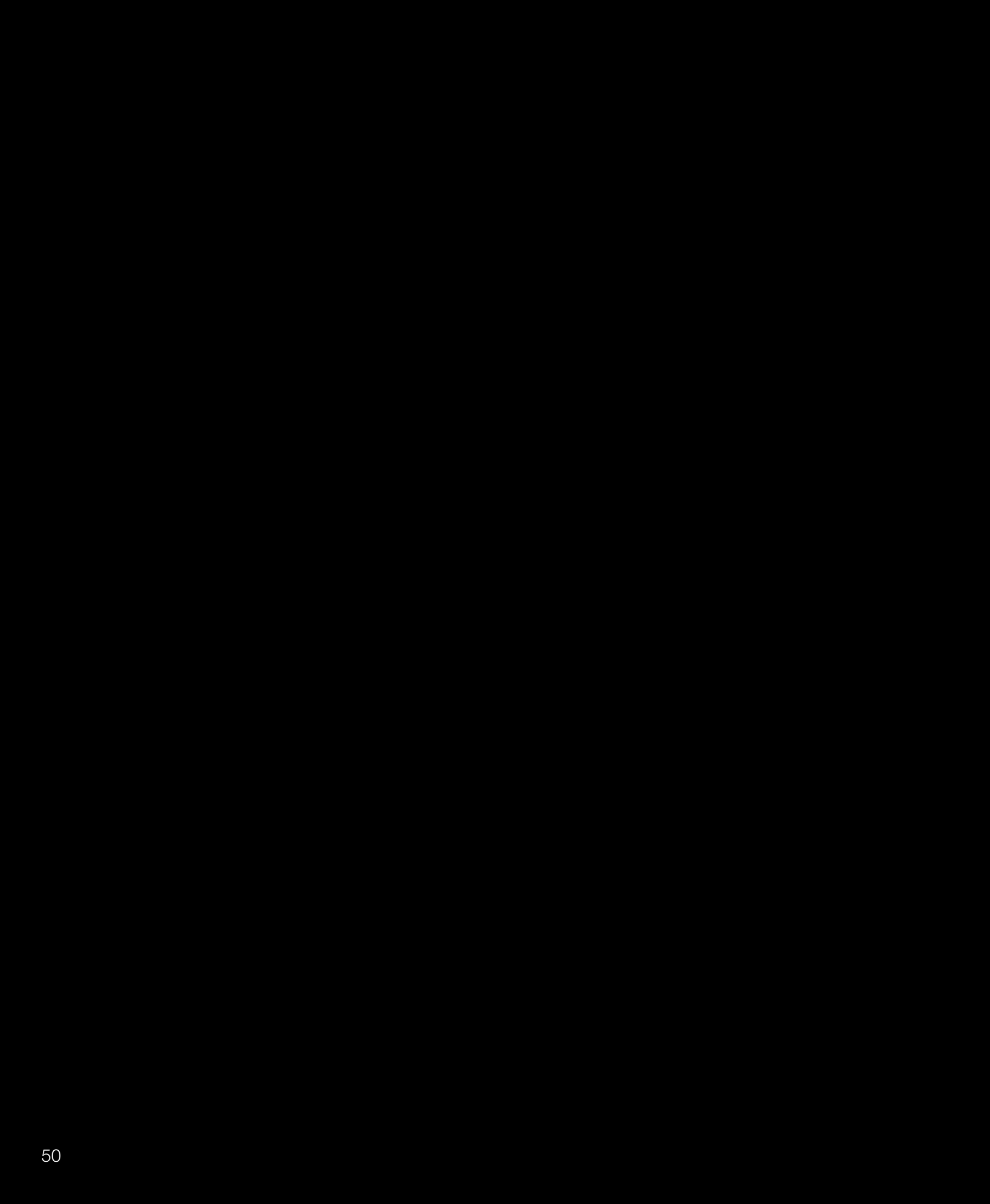









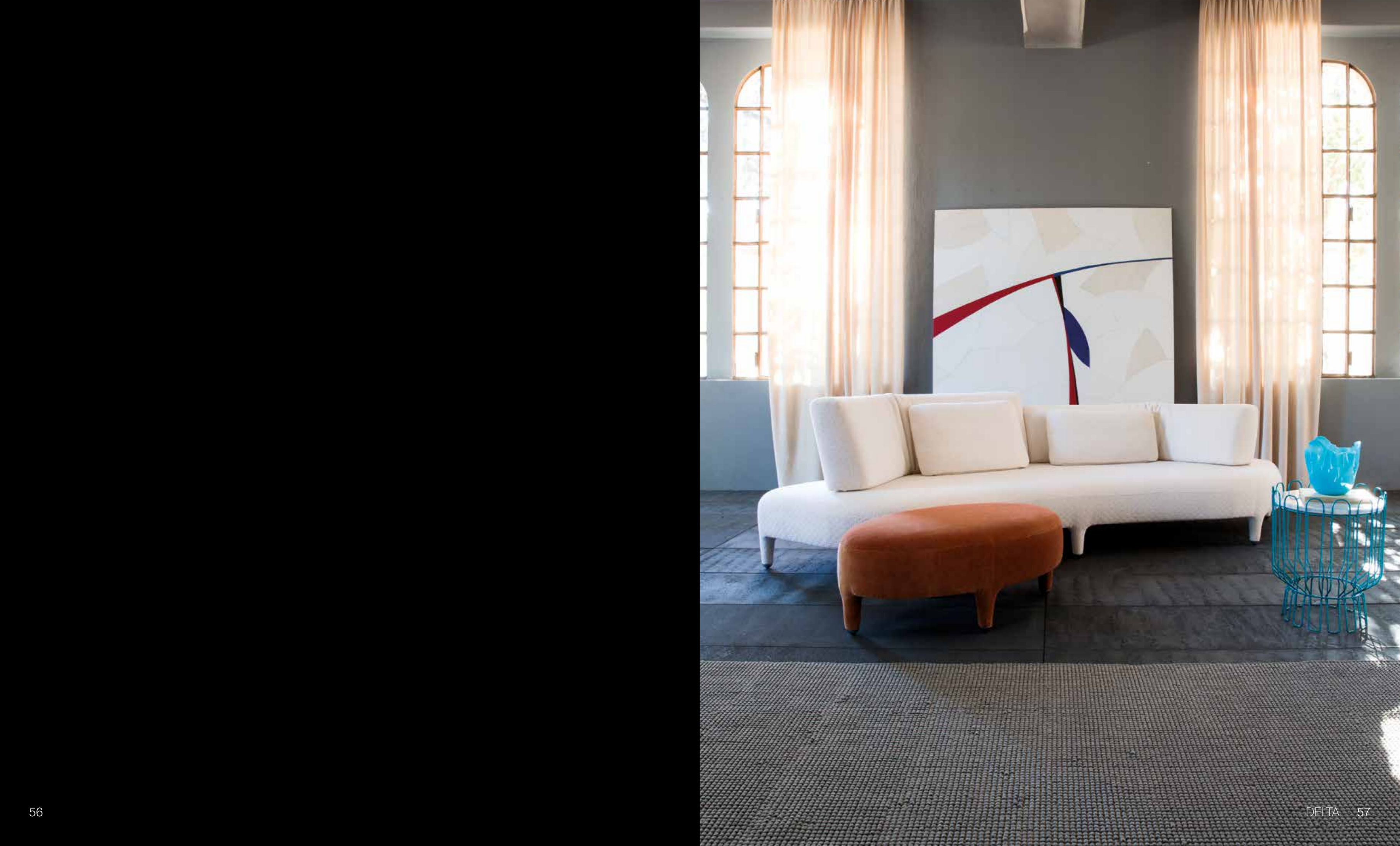















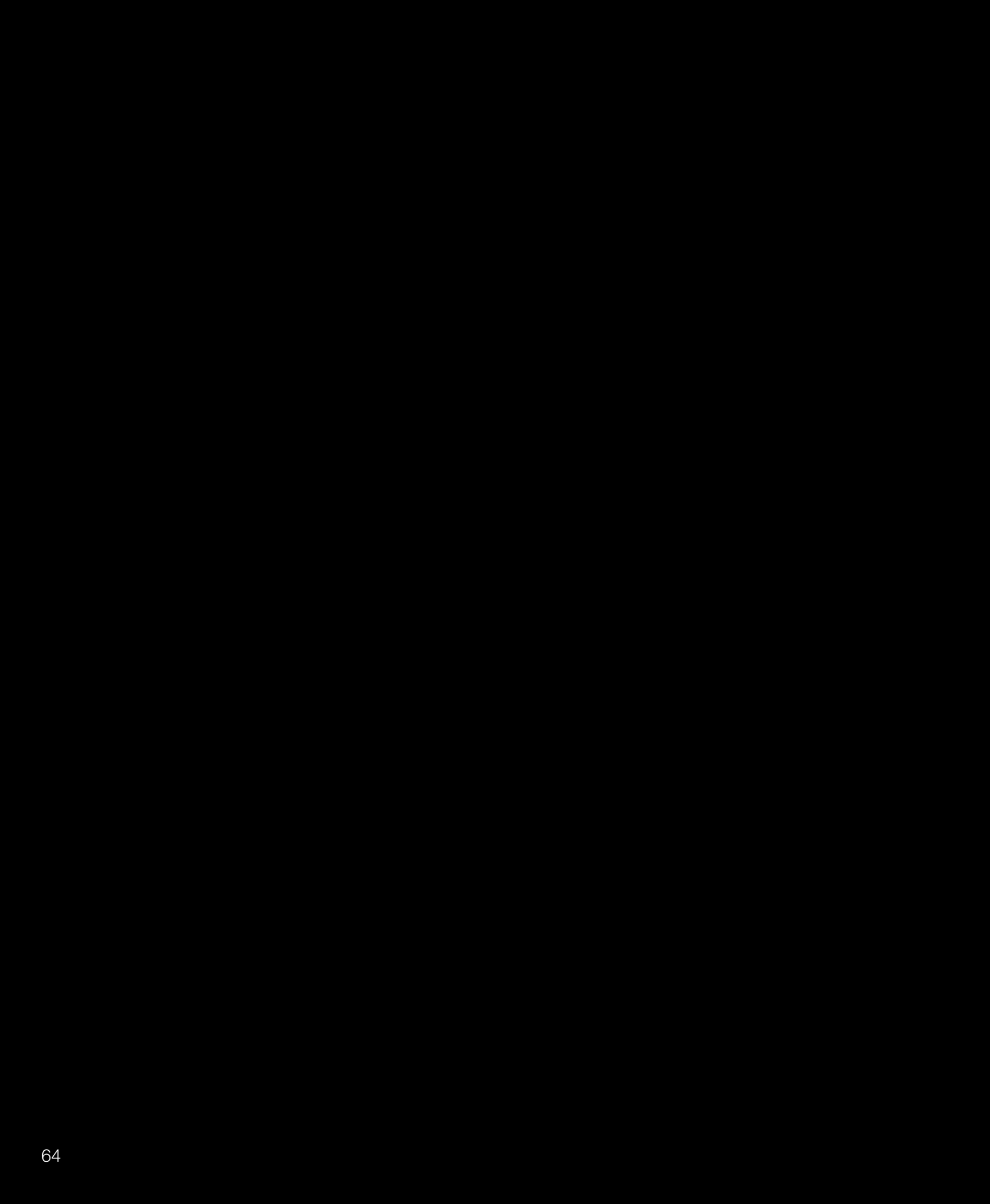

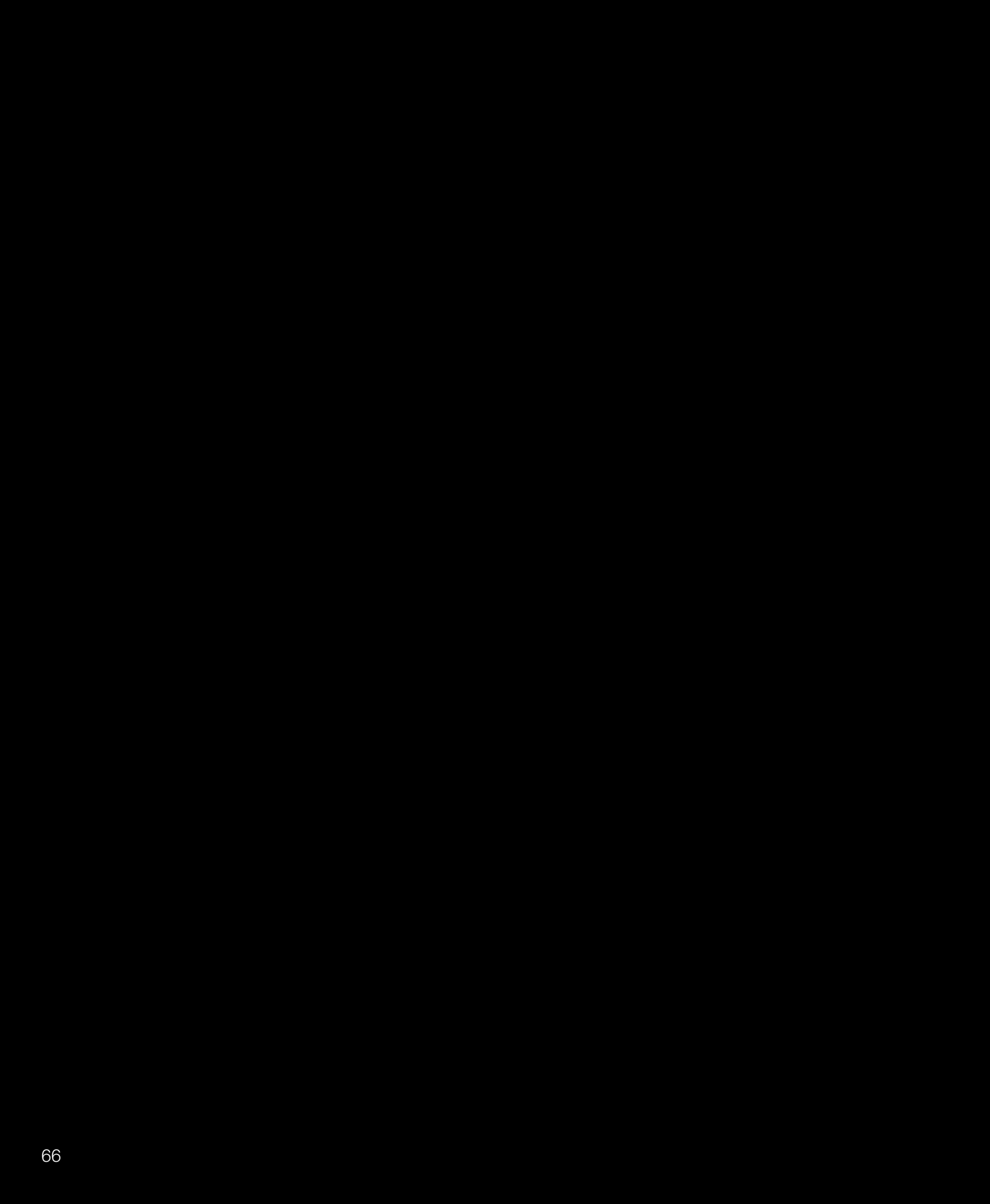









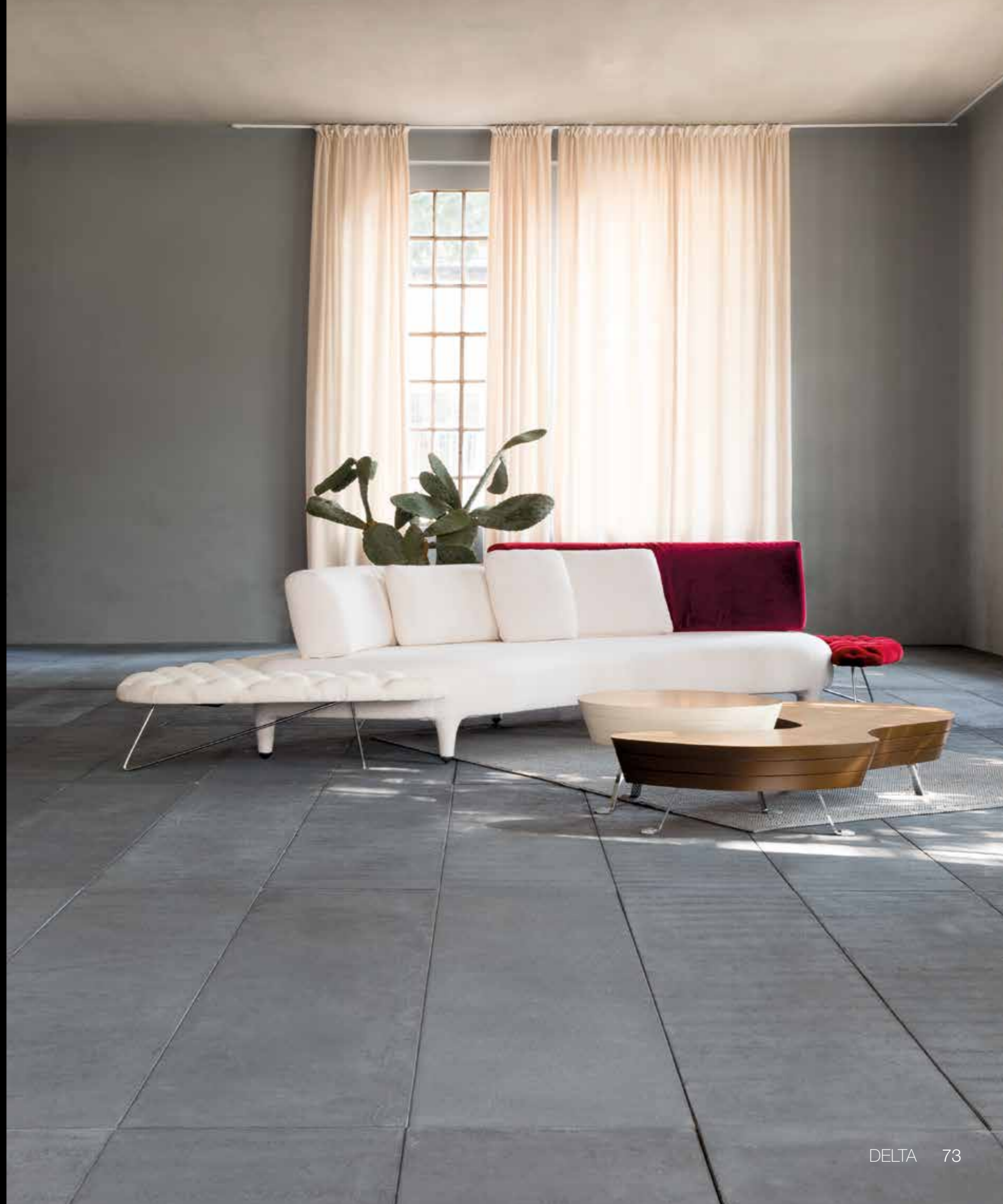
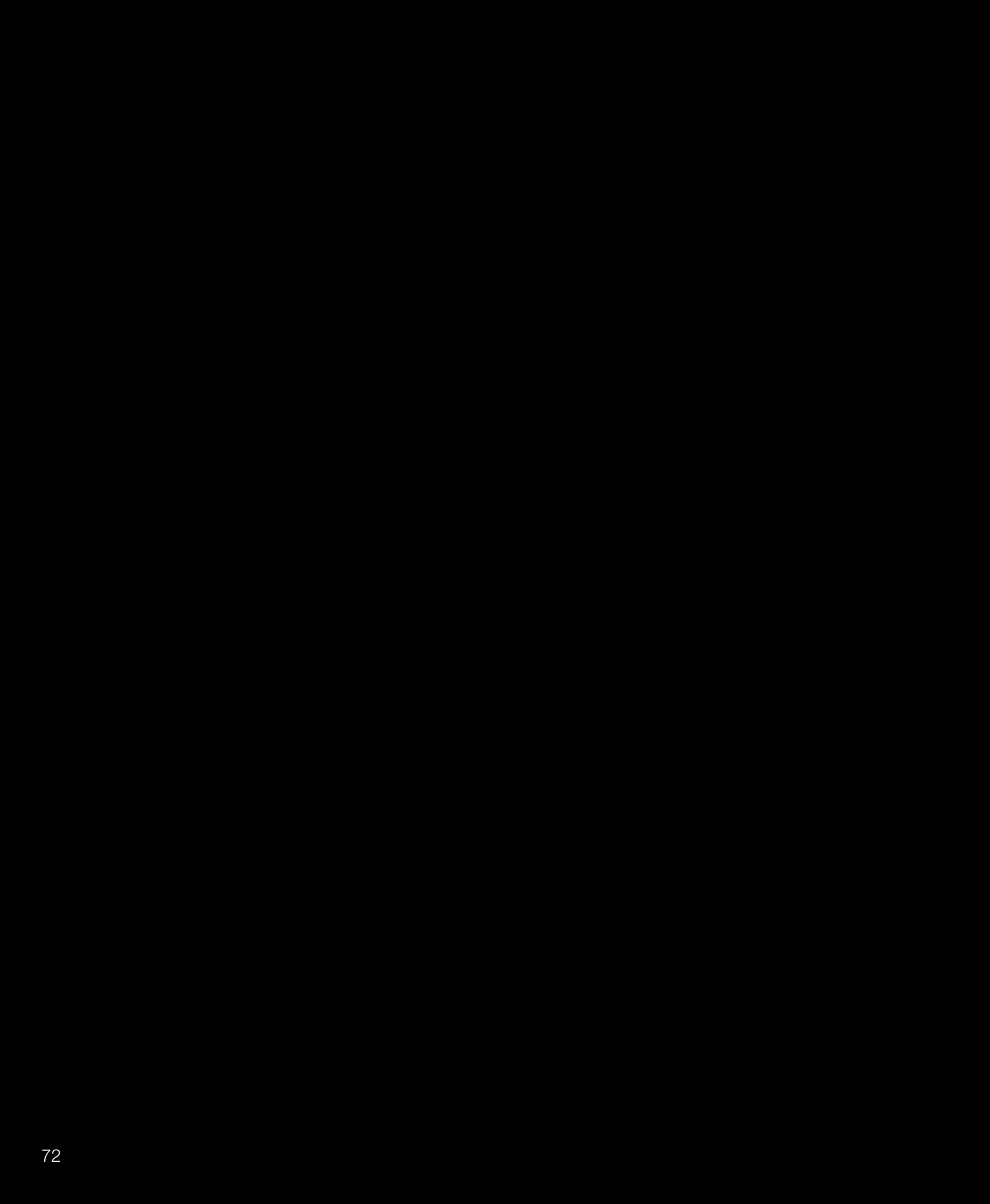





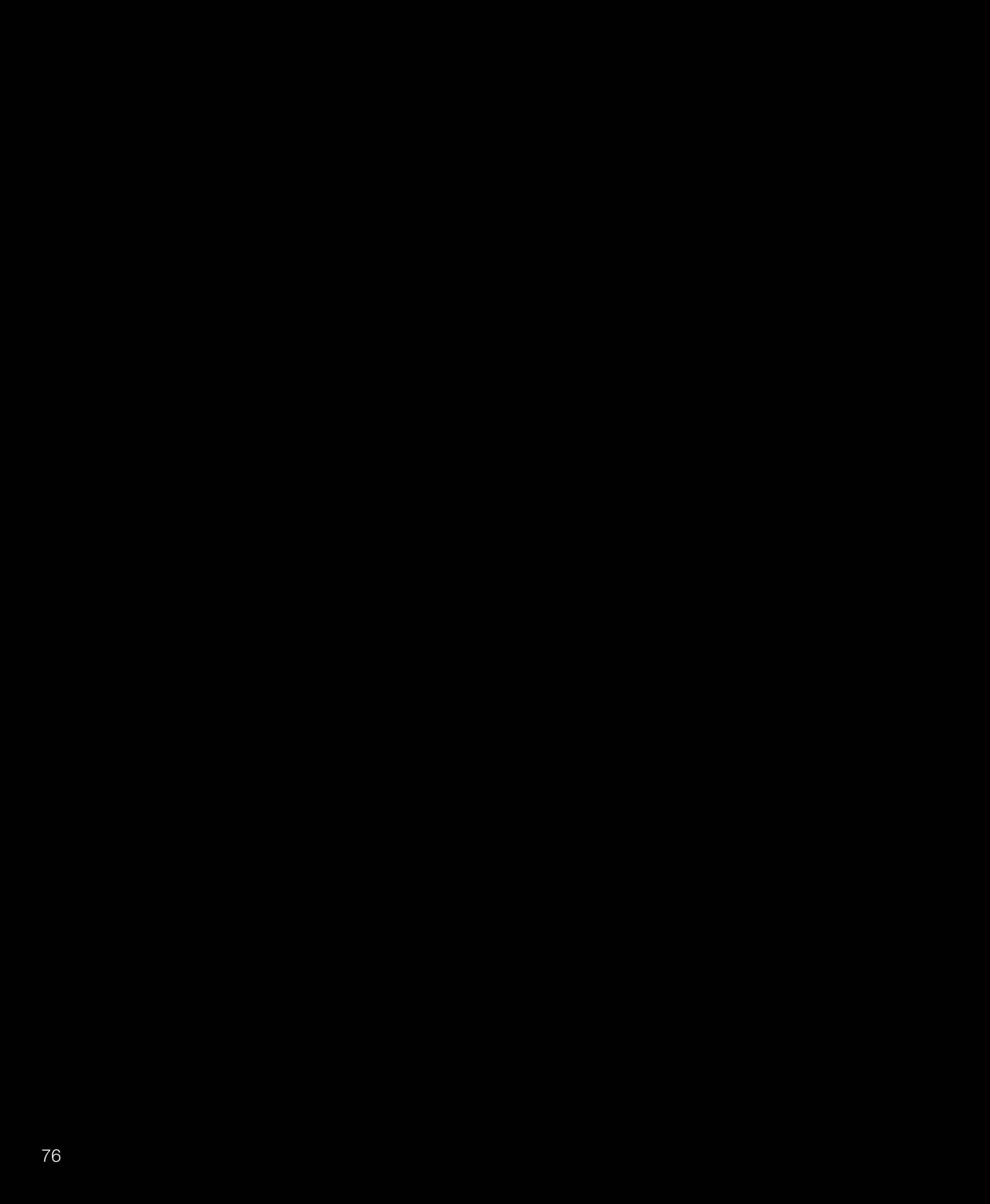

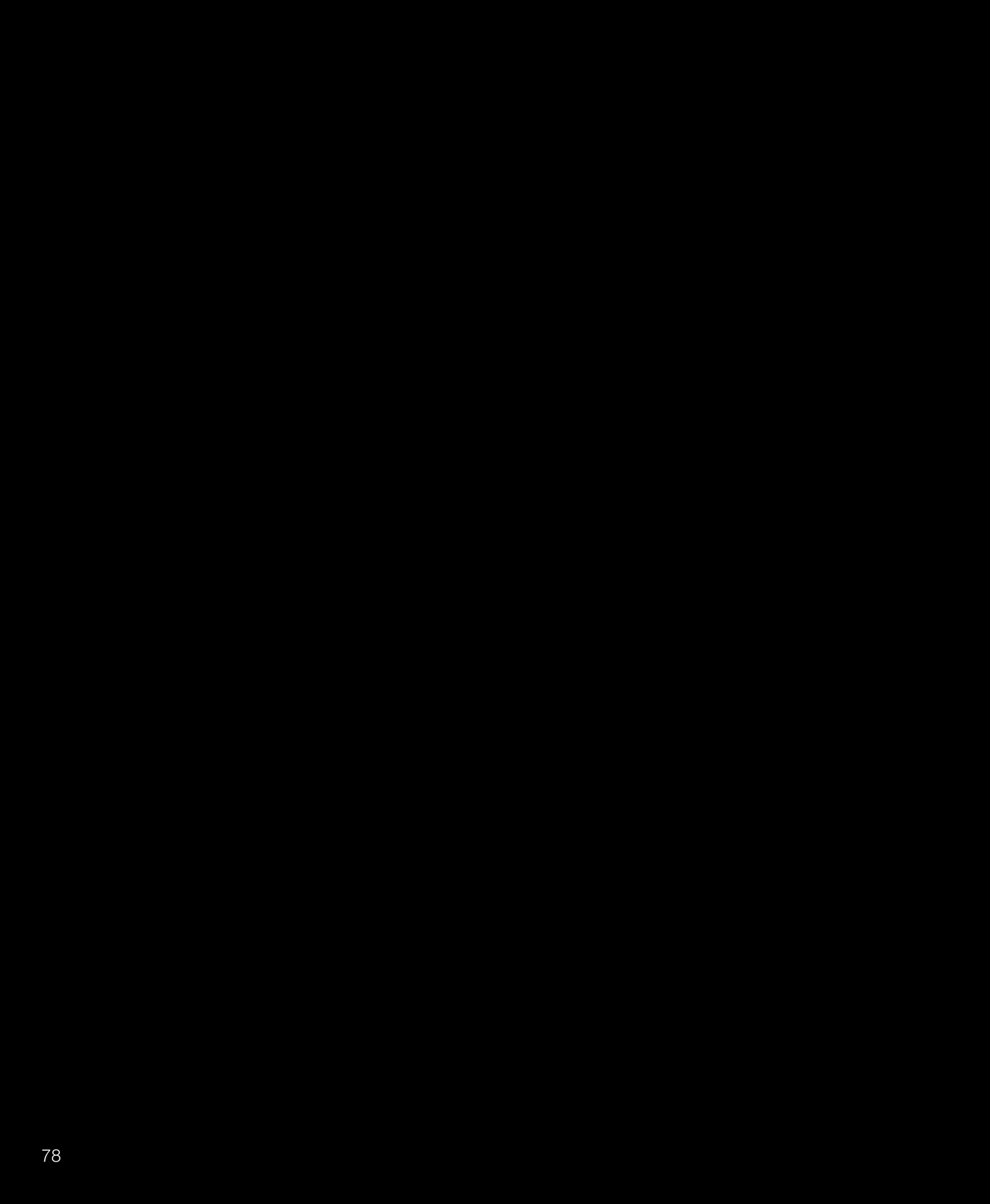





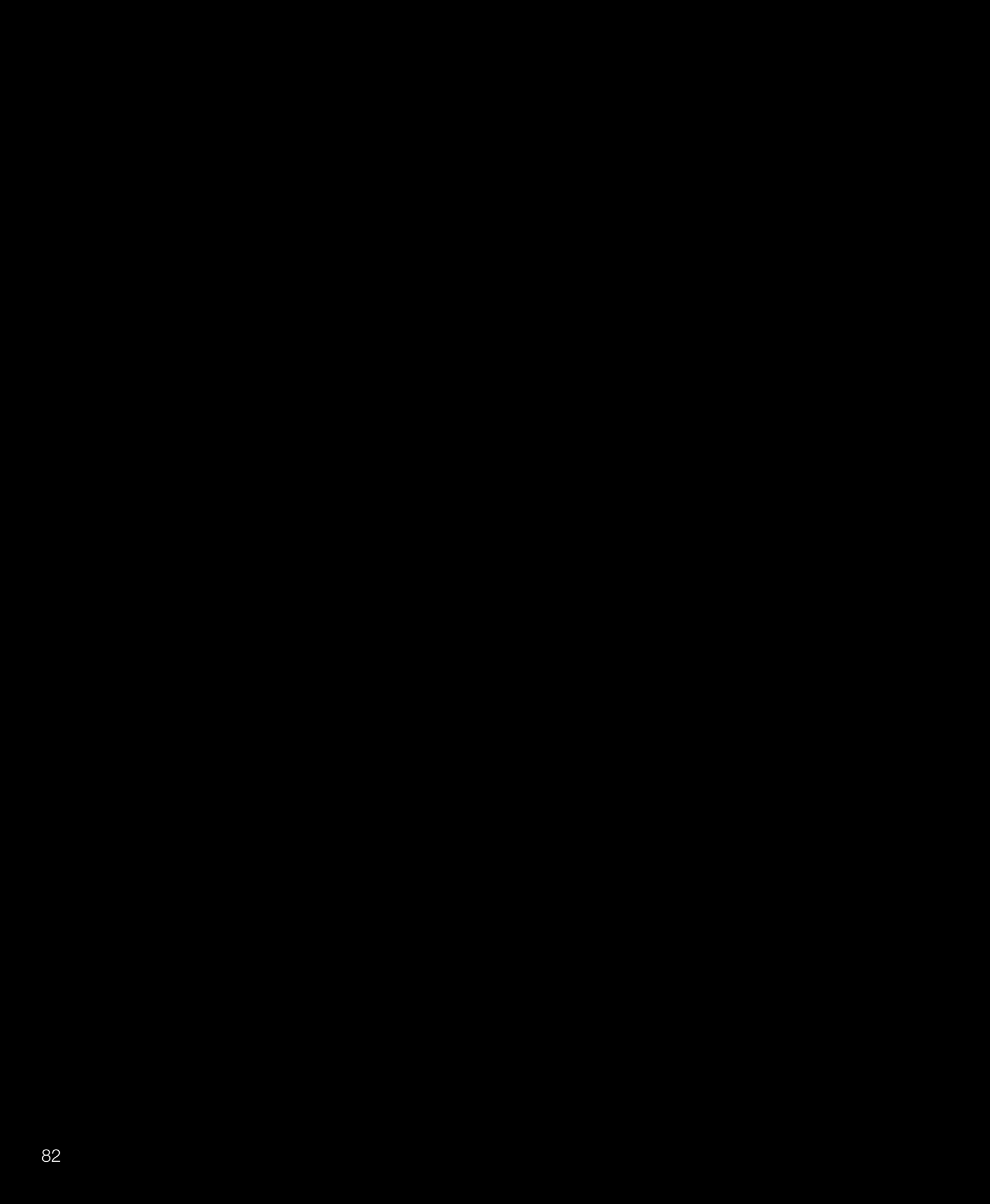















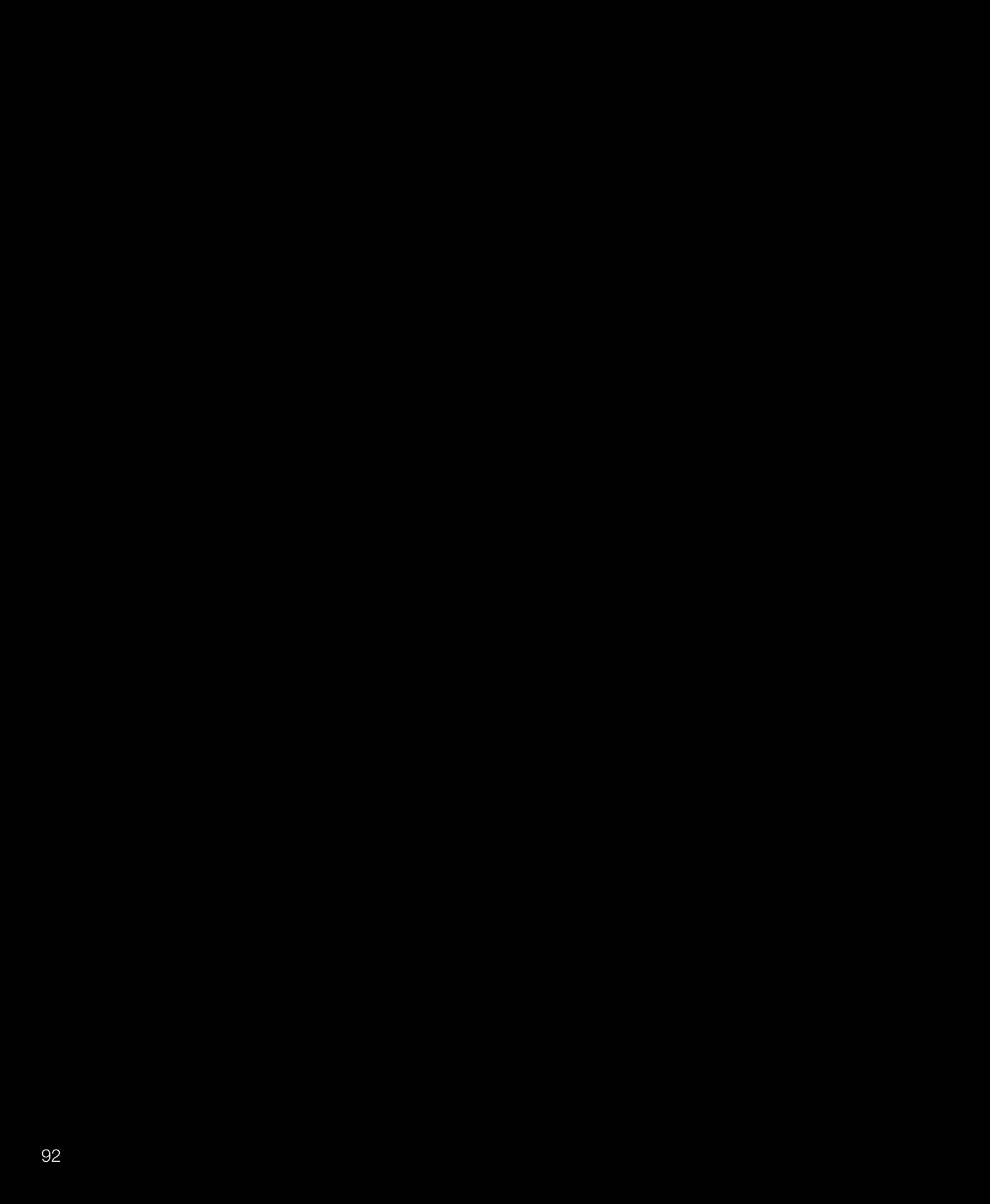





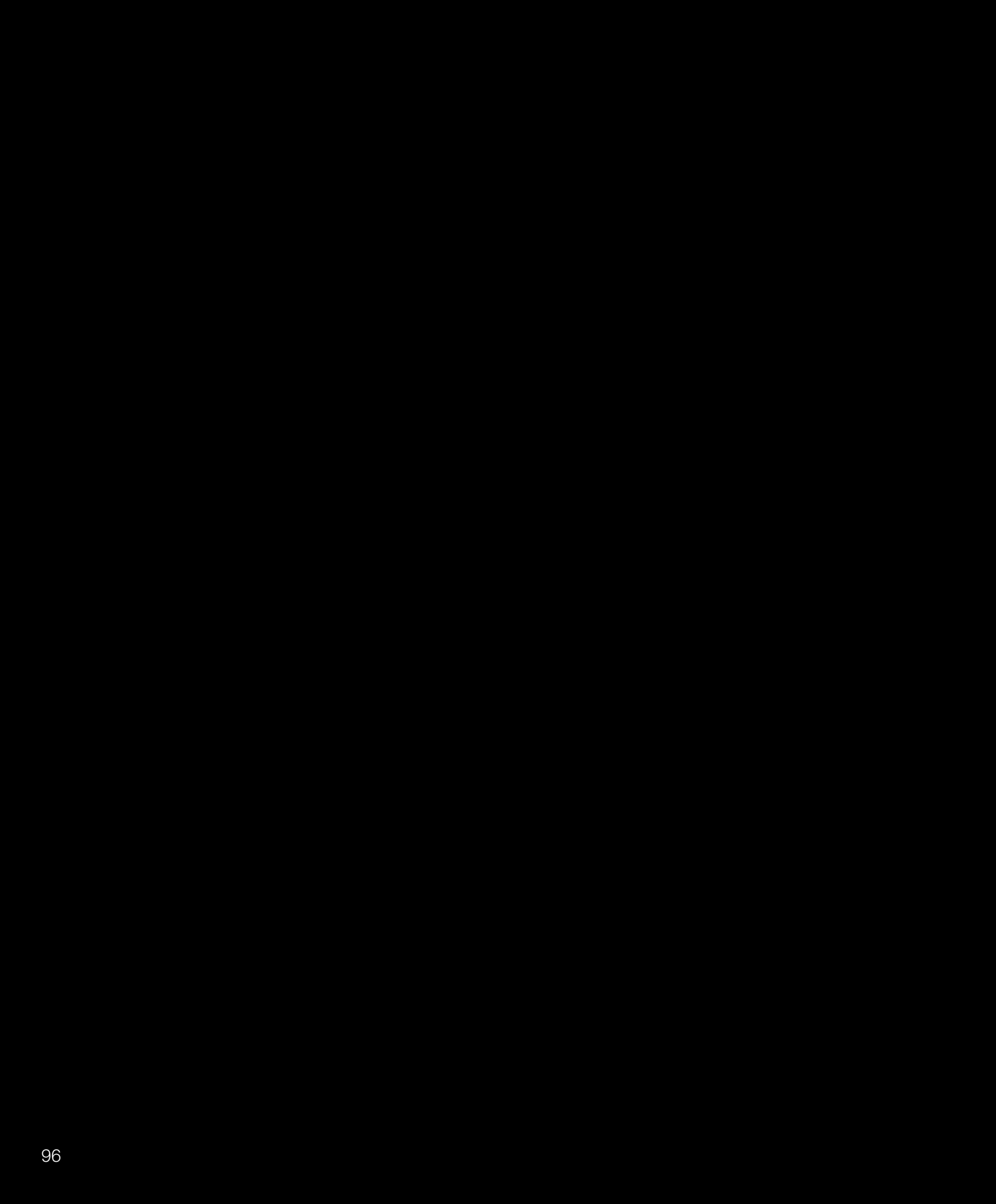

TULIP

Una poltrona in tubolare metallico dal sapore fortemente innovativo. Le fasce imbottite che realizzano lo schienale incorniciano la seduta creando delle linee morbide dall'aspetto molto accogliente.  
Una seduta elegante e senza tempo, capace di arredare con forte personalità lo spazio che la circonda.

*A tubular steel armchair with a powerfully innovative flavour. The back rest is created with padded strips that frame the seat, forming soft, comfortable lines with an irresistibly welcoming appeal.  
An elegant, timeless chair that adds a touch of real character to its surroundings.*

DESIGN: Castello - Lagravinese





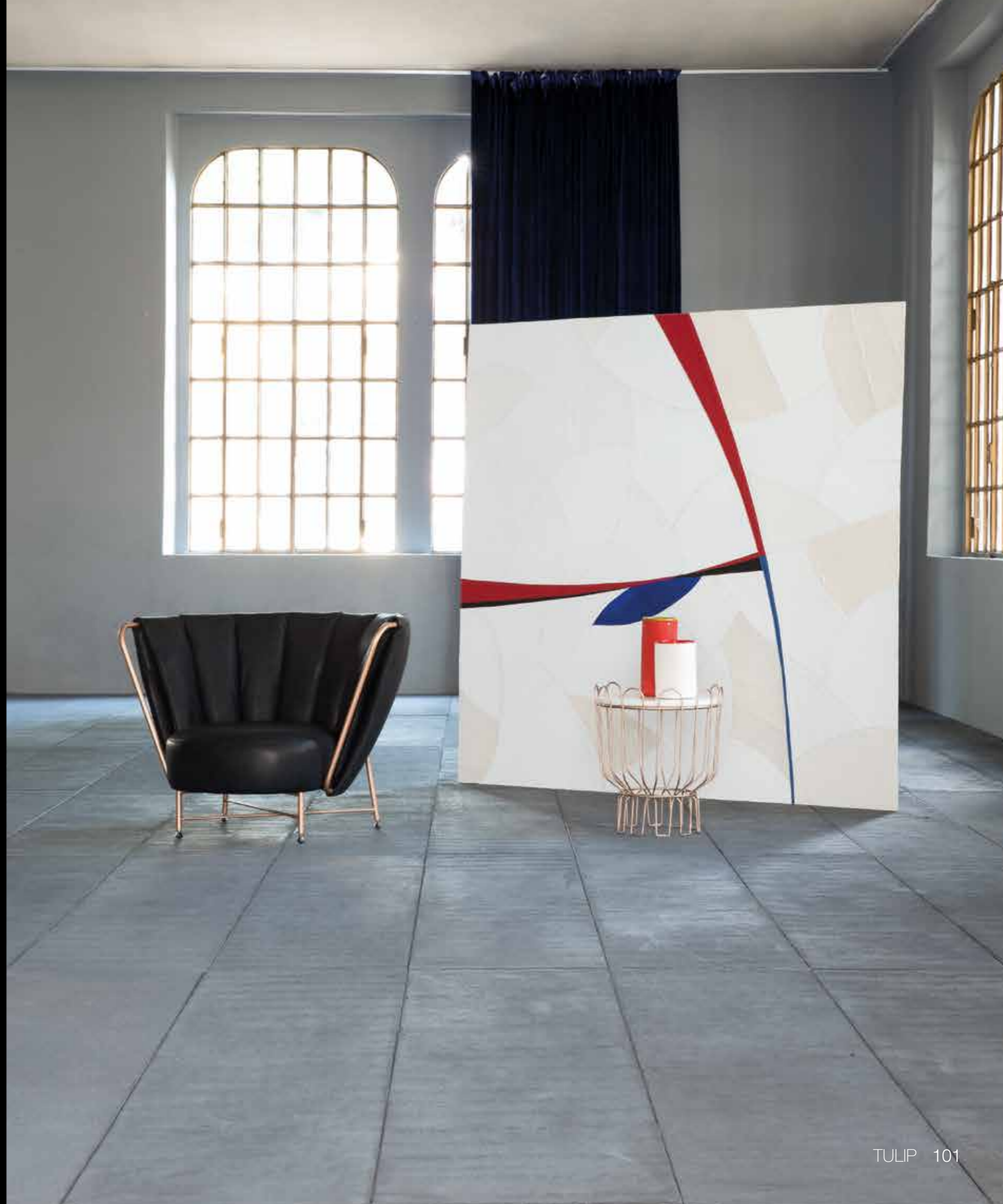
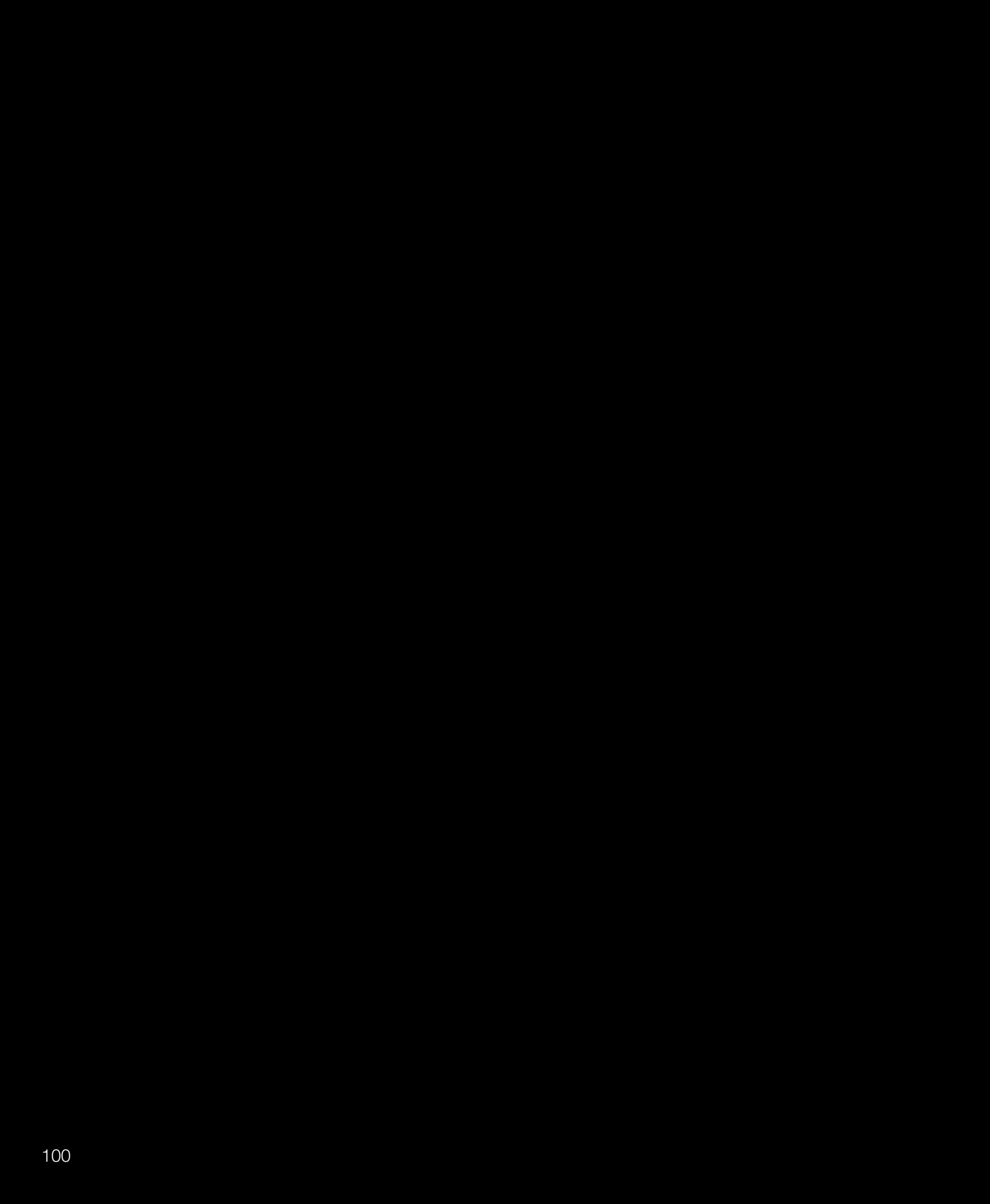

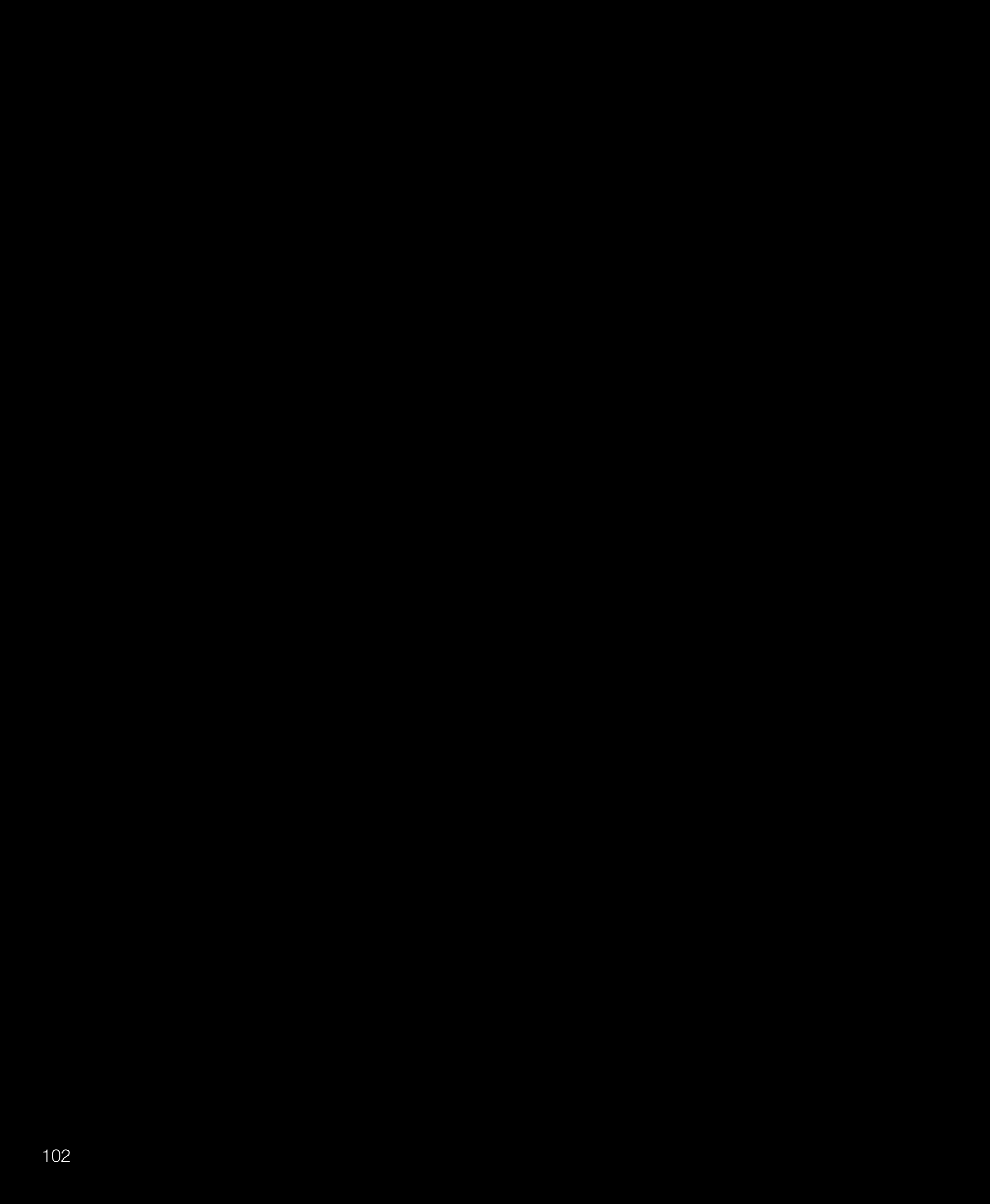



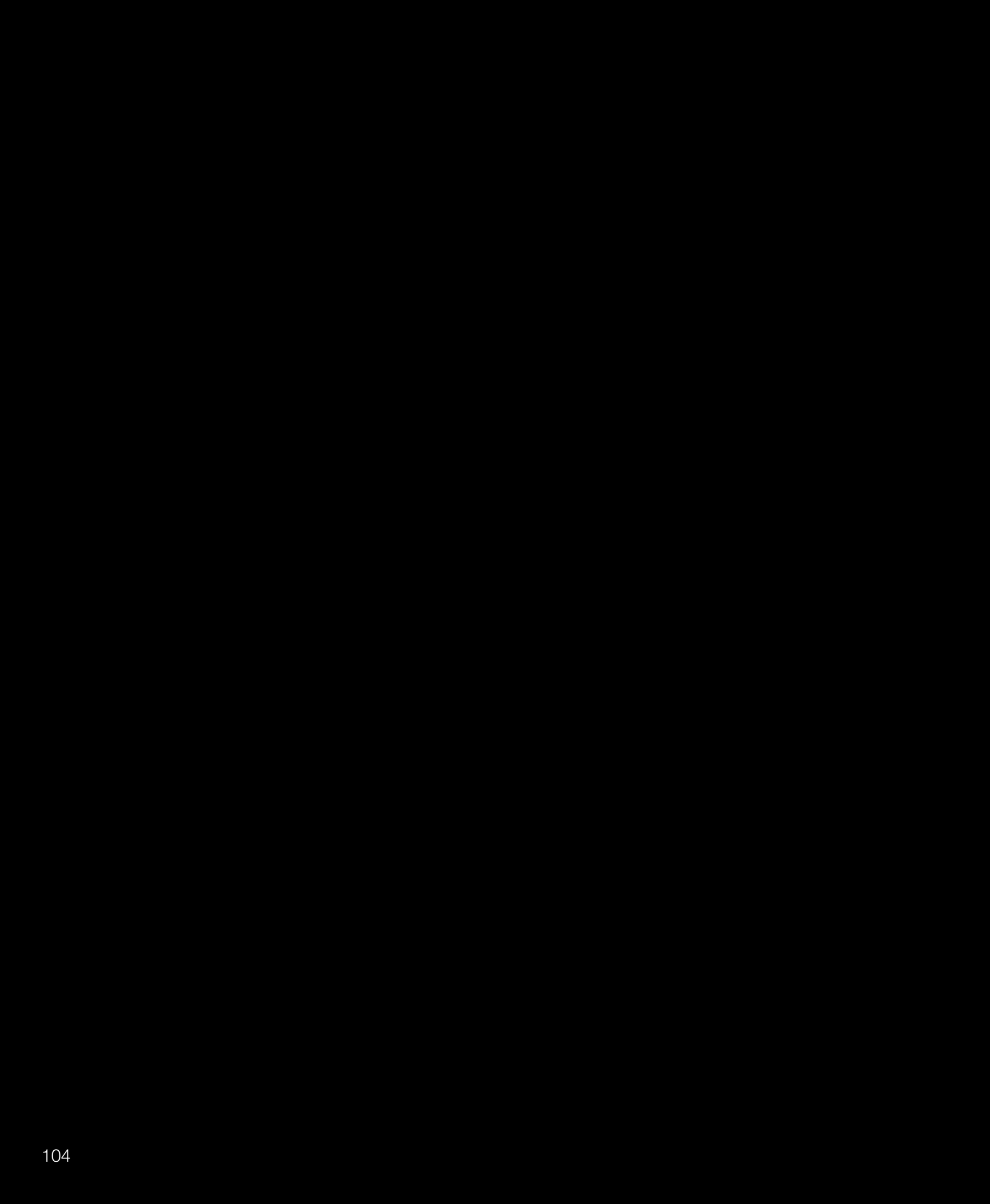









## DELTA

Delta è un letto matrimoniale dalle linee contemporanee, realizzato con una testata imbottita capitonnè. Un'espressione decisa di alta sartorialità grazie a rivestimenti e cuciture realizzate con massima cura in tutti i suoi dettagli. Un letto che racchiude tutta l'arte del saper fare degli artigiani e tessitori italiani.

*Delta is a double bed with contemporary lines and a button-tufted padded headboard. Every single aspect of the coverings and seams is crafted with the utmost attention to detail, providing a bold statement of absolute sartorial elegance. A bed that encapsulates all the artistry behind the know-how of Italian artisans and weavers.*

DESIGN: Castello - Lagravinese





## CALIPSO

*Una composizione insolita dall'apparente equilibrio instabile quella realizzata dai due volumi circolari sovrapposti che formano il tavolino "due altezze".*

*Due cilindri con bordo in legno laccato caratterizzano questo tavolino innovativo ispirato al mondo del lusso di qualità. Il top può essere realizzato nei legni della nostra collezione ed in marmo.*

*A "double-height" low table designed with two overlapping circular shapes that give the unusual composition an air of ostensible instability. Characterised by two cylinders edged with lacquered wood, this innovative low table draws inspiration from the world of high-end luxury. The top can be crafted in wood from our collection and also in marble.*

DESIGN: Castello - Lagravinese







NIDO

Questa serie di tavolini realizzati in tondino metallico arricchisce la casa con le sue linee moderne accostate a materiali ricercati. Come preziosi gioielli, sono disponibili in finiture con colori di tendenza o dal sapore più classico. Il top può essere realizzato nei legni della nostra collezione e anche in marmo.

*This series of low tables crafted with steel rods combines modern lines with sophisticated materials and will definitely enhance any home. Like precious jewels, these tables are available with finishes in trendy colours or with a more classic flavour. The top can be crafted in wood from our collection and also in marble.*

DESIGN: Castello - Lagravinese





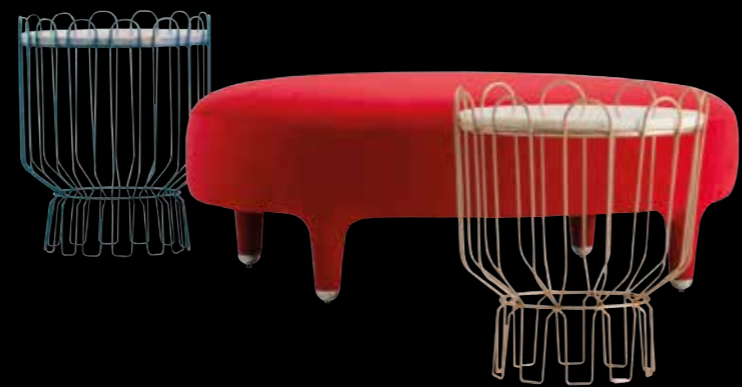

NIDO

Dalle linee della serie "tavolino Nido" nasce l'elegante "pouf Nido".  
Le curve sinuose del tondino metallico incorniciano un confortevole cuscino che completa la geometria raffinata del pouf.  
Un prodotto dall'estetica ricercata che offre una seduta dalle forme ironiche e vanitose.

*The elegant "Nido pouf" is inspired by the lines from the "Nido low table" series. The sinuous curves of the steel rods frame a comfortable cushion that adds the finishing touch to the pouf's refined structure. With its sophisticated looks, this pouf offers a seating alternative with proud, ironic forms.*

DESIGN: Castello - Lagravinese





DELTA

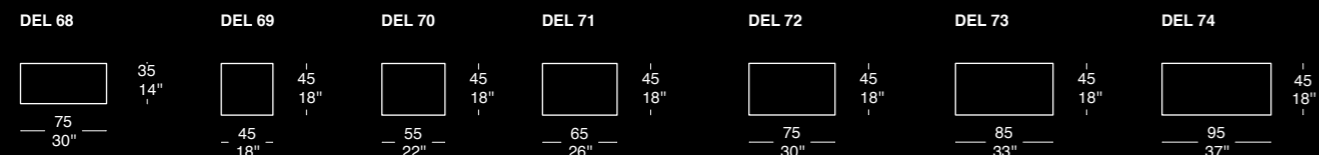
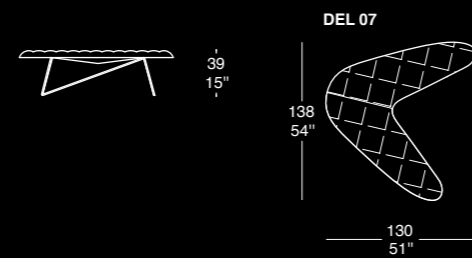
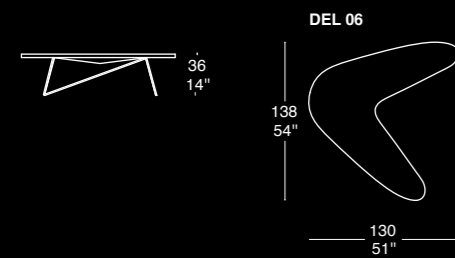
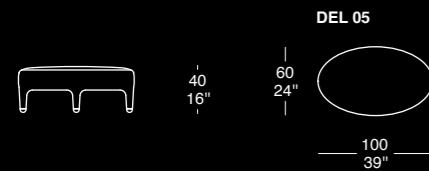
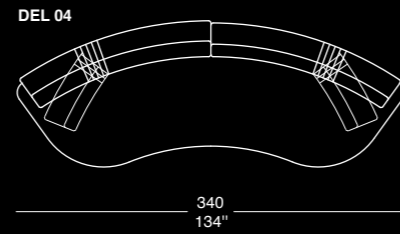
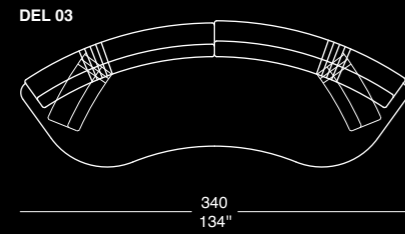
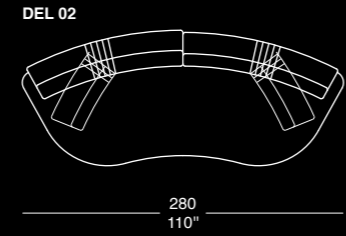
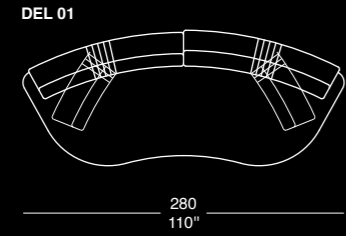
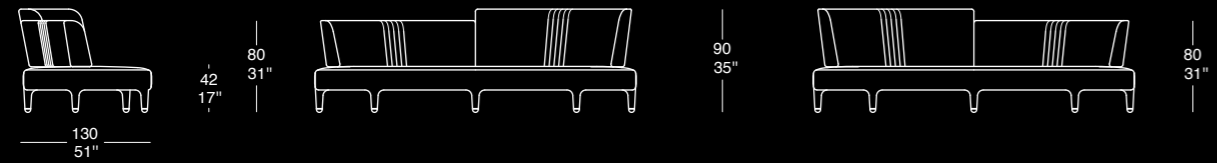

DELTA

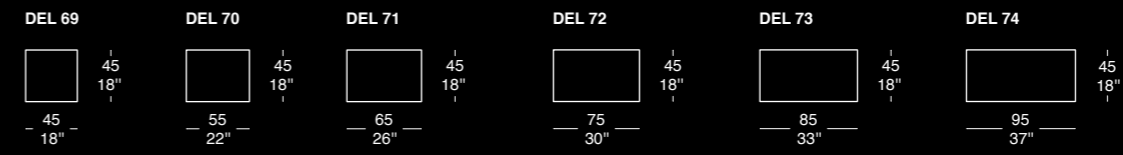
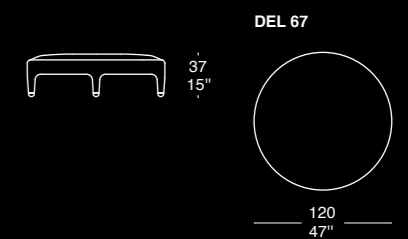
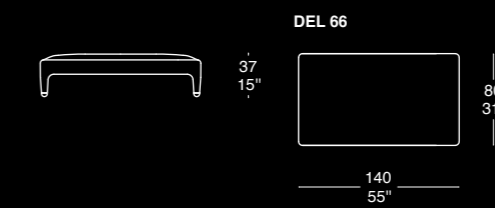
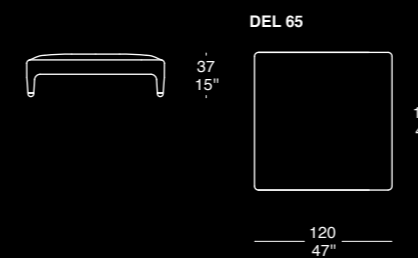
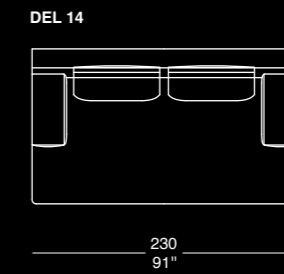
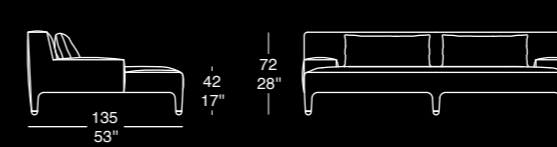
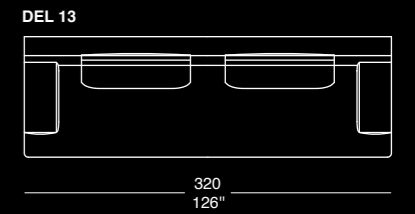
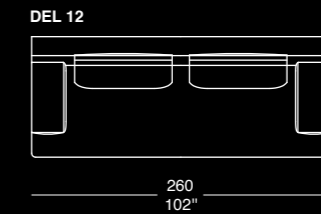
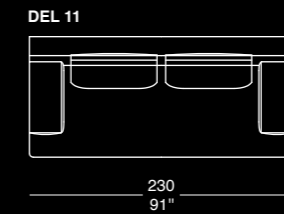
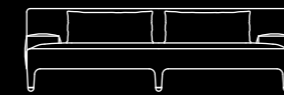
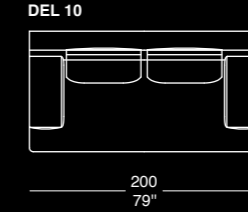
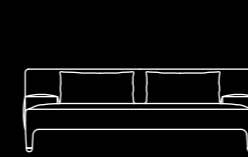
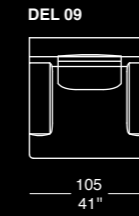

DELTA

DEL 19

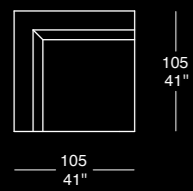

DEL 20

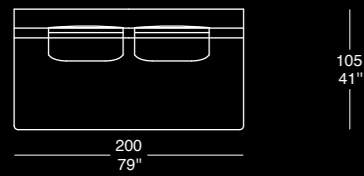

DEL 21

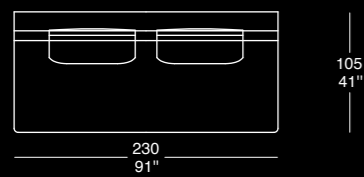

DEL 22

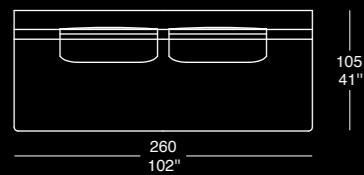

DEL 23

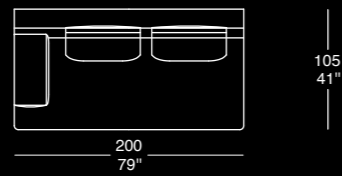

DEL 24

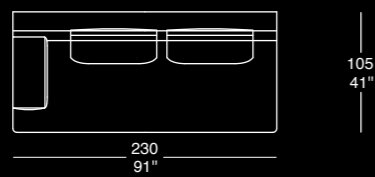

DEL 25

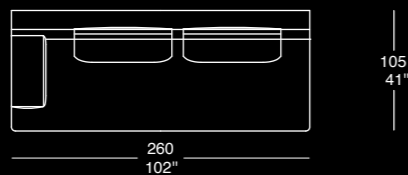

DEL 26

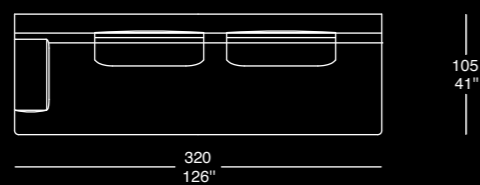

DEL 27

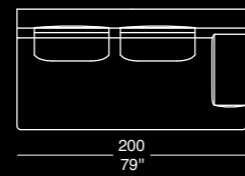

DEL 28

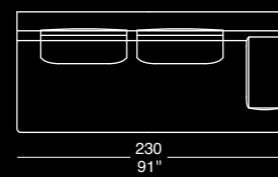

DEL 29

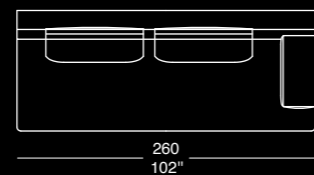

DEL 30

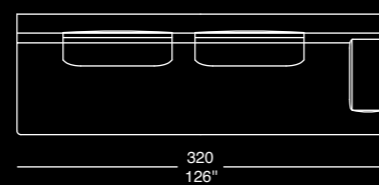

DELTA

DEL 31

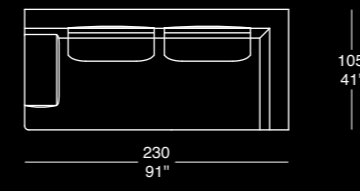

DEL 32

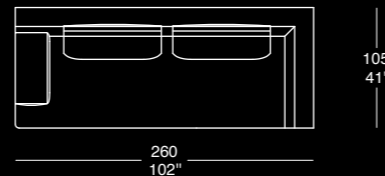

DEL 33



DEL 37

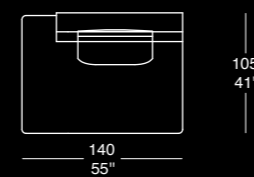

DEL 38

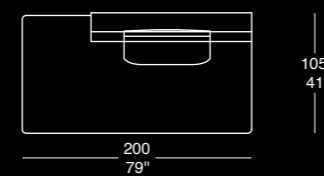

DEL 34

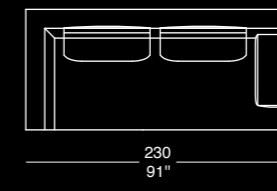

DEL 35

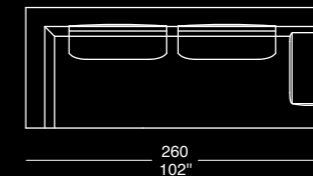

DEL 36

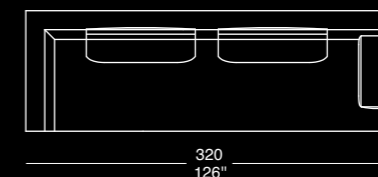

DEL 39

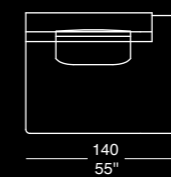

DEL 40

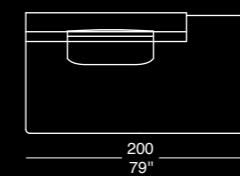

DEL 41

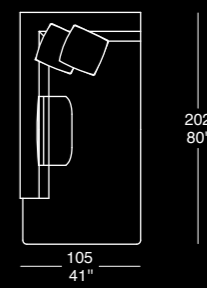

DEL 42

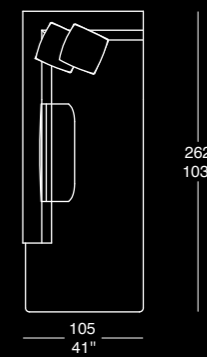

DEL 45

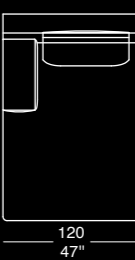

DEL 43

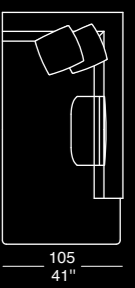

DEL 44

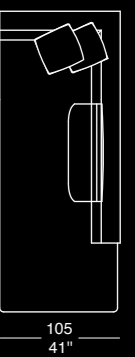

DEL 46

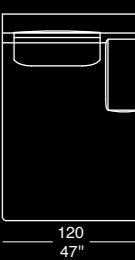



DELTA

DEL 47

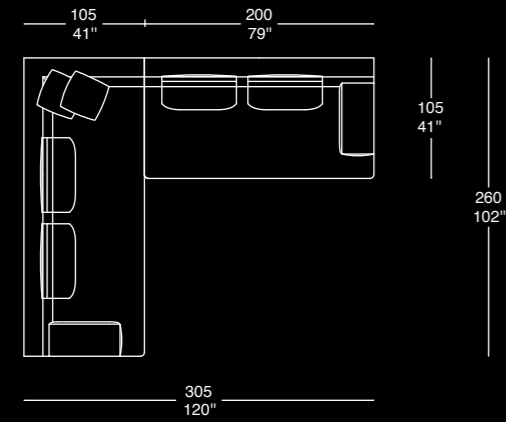

DEL 48

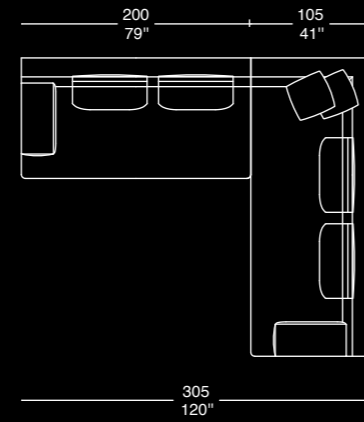

DEL 49

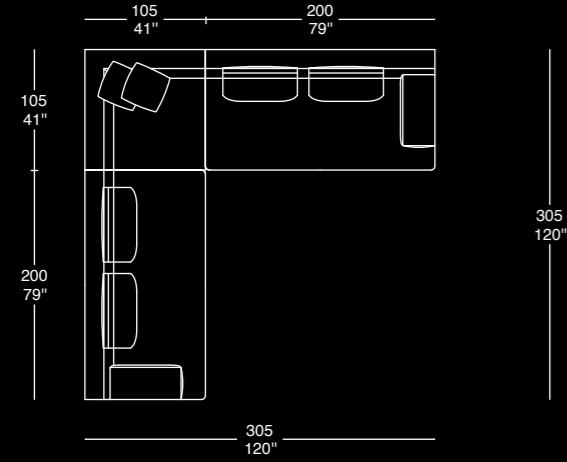

DEL 50

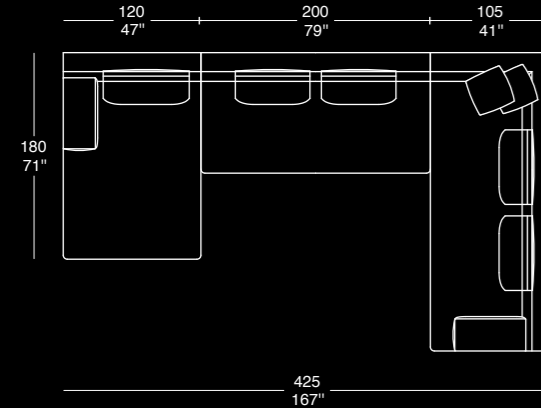

DEL 51

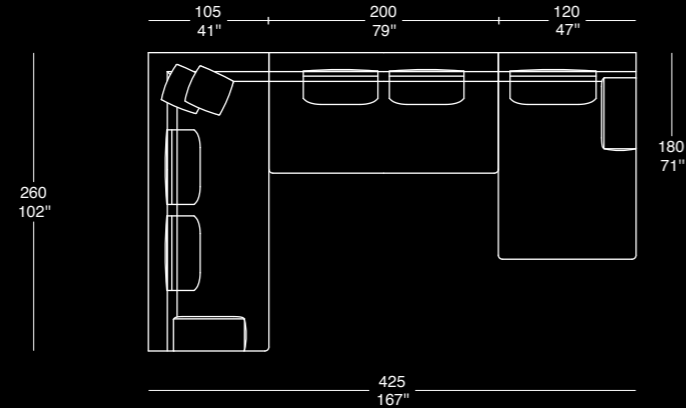

DELTA

DEL 52

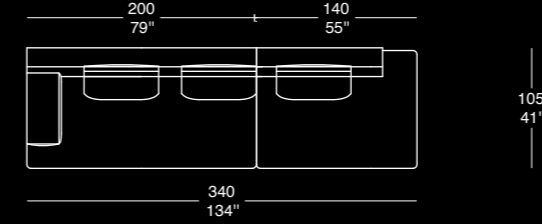

DEL 53

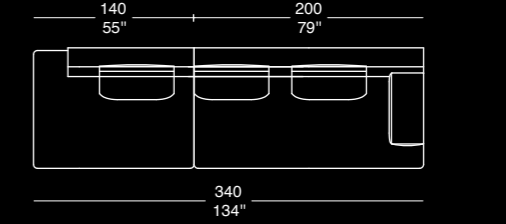

DEL 54

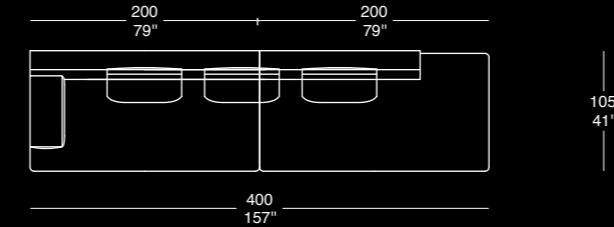

DEL 55

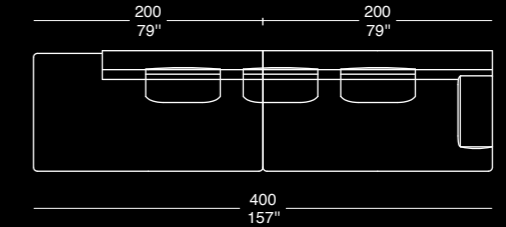

DEL 56

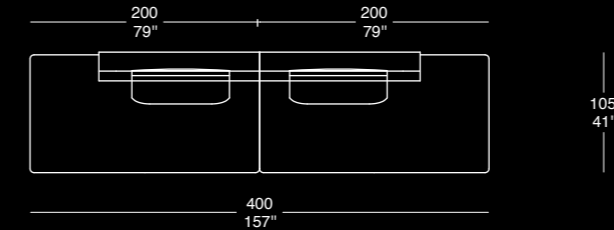

DEL 57

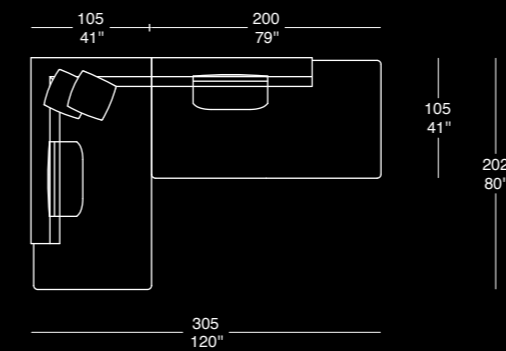

DEL 58

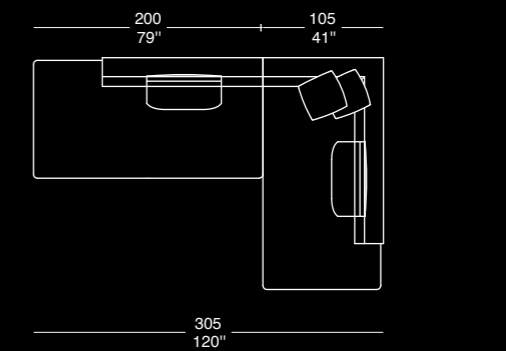

DELTA

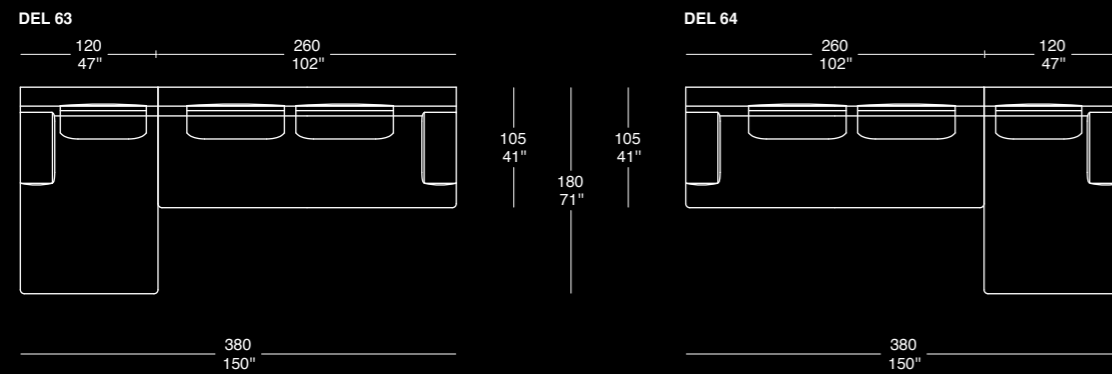
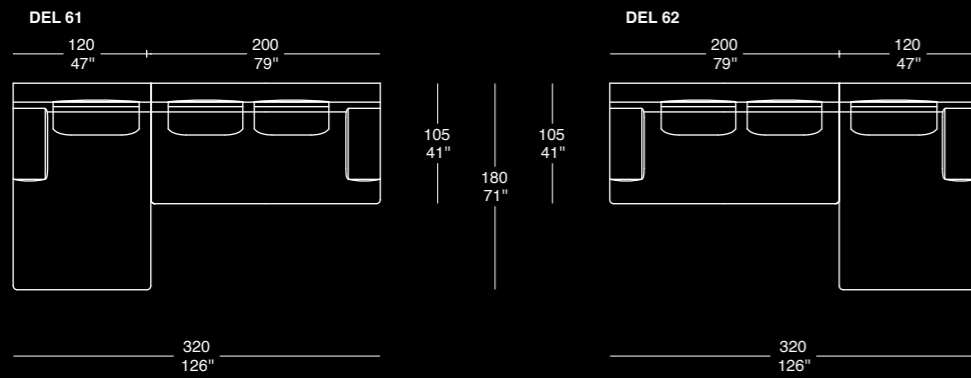
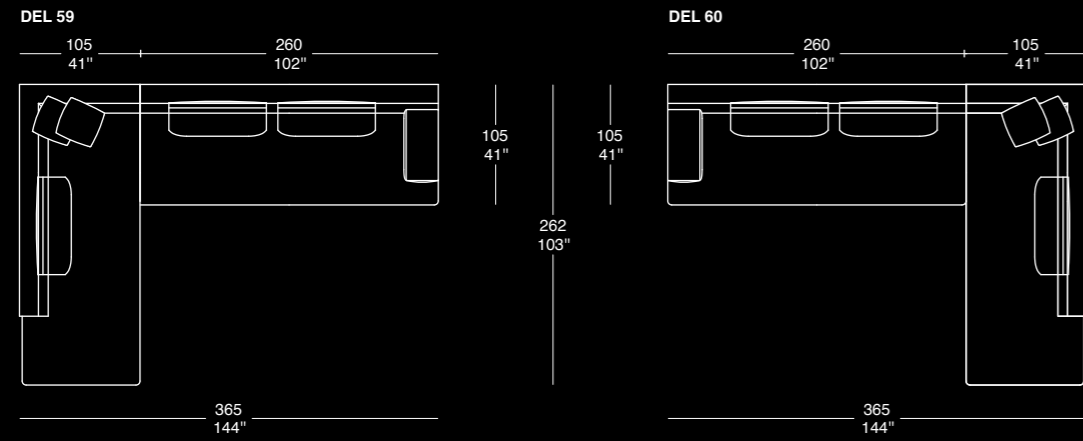

DORYS

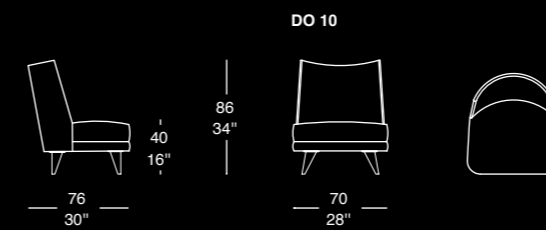

JADA

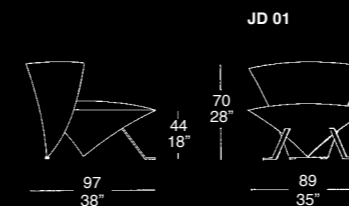

KENDA

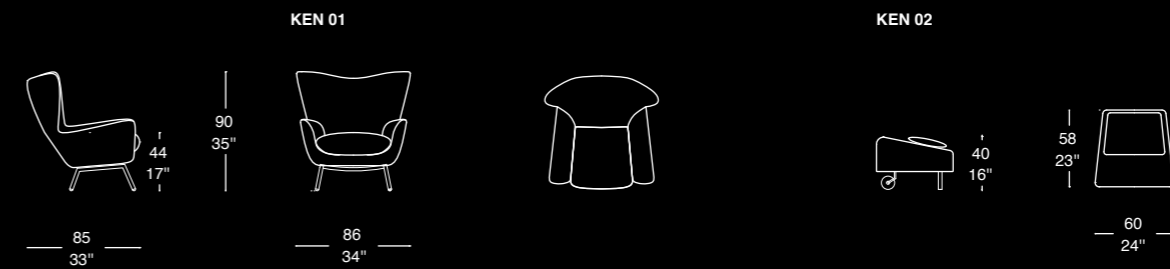

TULIP

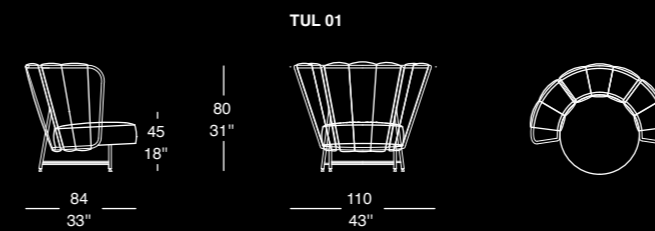



KYA

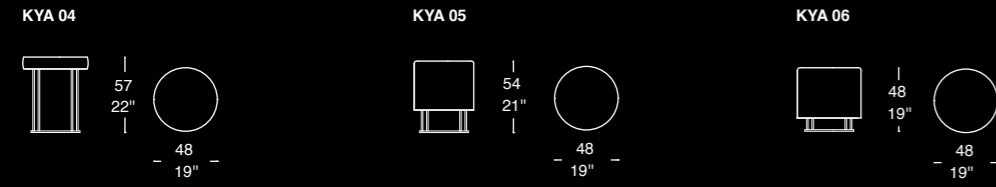

NIDO

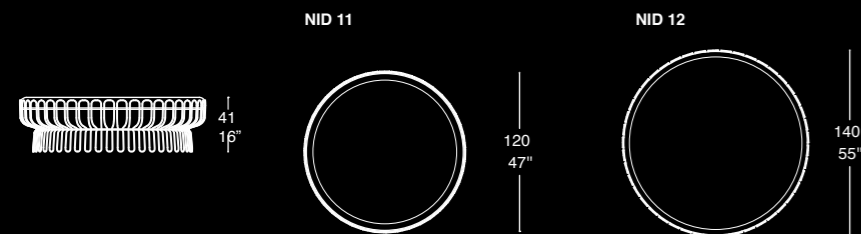
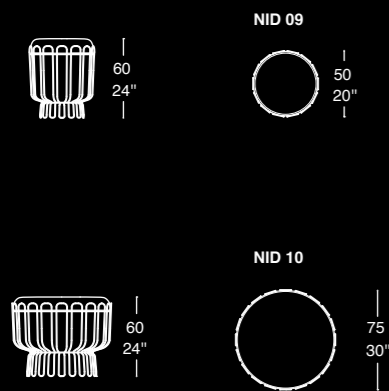

N.B. Base in metallo verniciato; la finitura cromata o satinata non è disponibile per questa base.  
N.B. Lacquered steel base; the chrome or satin finish are not available for this base.

CALIPSO

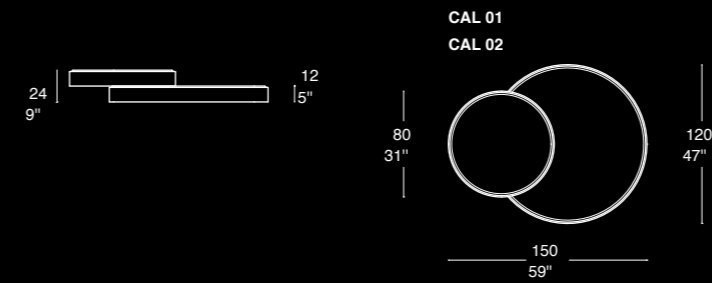

**CAL01**  
N.B. Top: prodotto in tutte le nostre finiture di legni  
Bordo: prodotto solo nelle finiture di legni laccati  
N.B. Top: produced in all our wooden finishing.  
Border: produced only in lacquered wooden finishing.

**CAL02**  
N.B. Solo base per top in marmo.  
Bordo: prodotto solo nelle finiture di legni laccati.  
Prezzo del top in marmo da quantificare in base al tipo di marmo selezionato.  
N.B. Base only for the marble top.  
Border: produced only in lacquered wooden finishing.  
The price of the marble top will be calculated according to the type of marble chosen.

JOHN

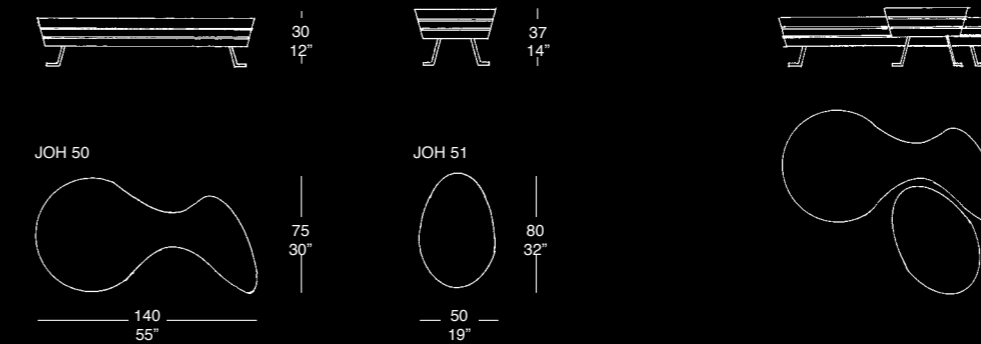

NIDO

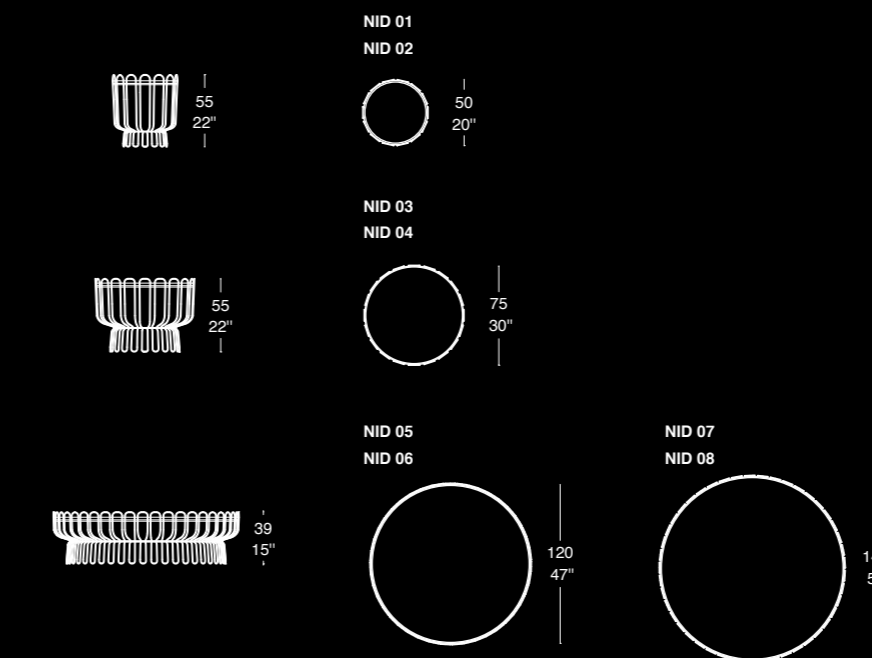

**NID 01 – NID 03 – NID 05 – NID 07**  
N.B. Base in metallo verniciato; la finitura cromata o satinata non è disponibile per questa base.  
N.B. Lacquered steel base; the chrome or satin finish are not available for this base.

**NID 02 – NID 04 – NID 06 – NID 08**  
N.B. Base in metallo verniciato; la finitura cromata o satinata non è disponibile per questa base.  
Solo base per top in marmo.  
Prezzo del top in marmo da quantificare in base al tipo di marmo selezionato.  
N.B. Lacquered steel base; the chrome or satin finish are not available for this base.  
Base only for the marble top.  
The price of the marble top will be calculated according to the type of marble chosen.

DELTA

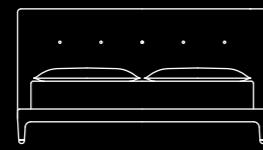
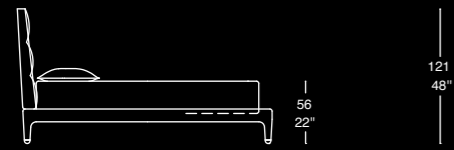

DEL 80 ST

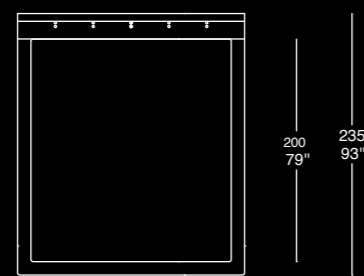

180  
71"  
205  
80"

DEL 82 QS

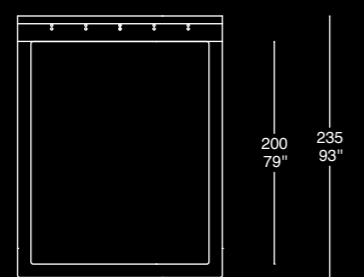

160  
63"  
185  
72"

DEL 84 KS

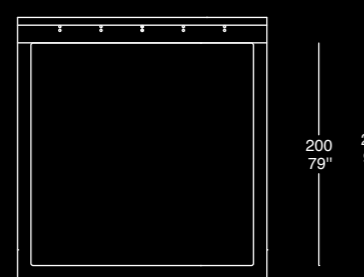

200  
79"  
225  
88"

DEL 86

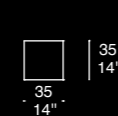

DEL 87



DEL 88

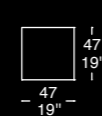

DEL 89

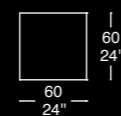

DEL 90

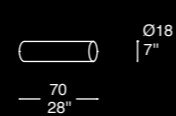

TA 79

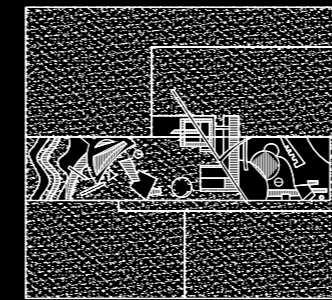

"BA"

TA 80

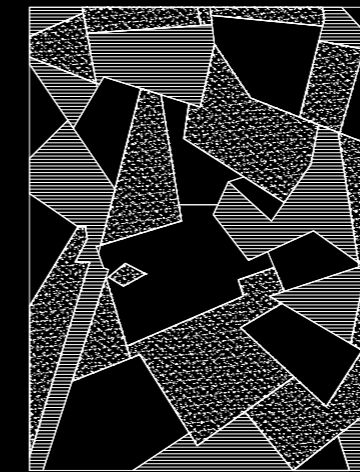

"BB"

TA 81

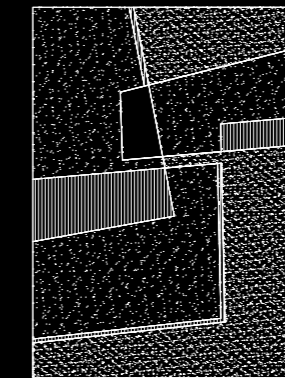

"BC"

TA 82

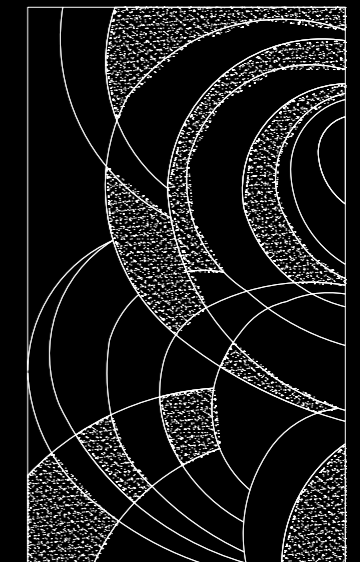

"BD"

TA 83

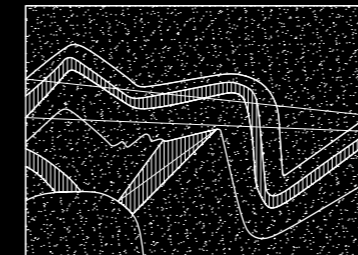

"BE"

TA 84

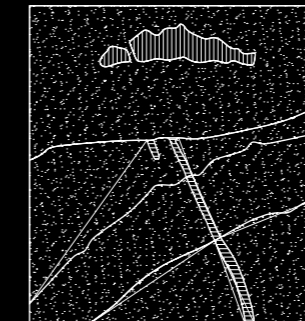

"BF"

TA 85

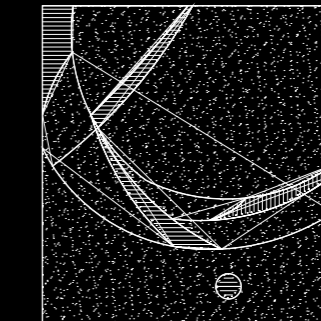

"BG"

TA 86

sfumatura di grigi

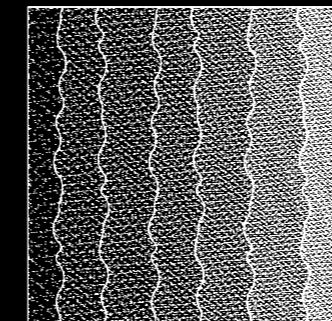

TA 87

sfumatura di beige

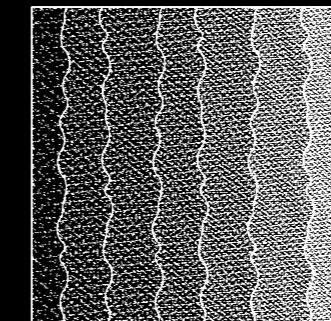



Credits:

AD: 4MMG.IT

Photo: Lillo e Giorgio Giovara

Print: Arti Grafiche Fiorin

Printed in Italy March 2014

Servizi tavola, oggettistica ed illuminazione  
*Tableware, homeware and lighting*

[www.borlaelite.com](http://www.borlaelite.com)

*Borla*  
dal 1890

I colori dei tessuti, delle pelli e dei legni delle nostre realizzazioni fotografate su questo catalogo,  
possono non essere perfettamente riprodotti in stampa.

*The reproduction of the colours of our fabrics, leather and wood photographed in this catalogue  
may vary slightly from the original shade due to printing.*

