

KIDSCOLLECTION



Il Loft

A UNIQUE APPROACH — IL LOFT

Design 100% italiano e materiali esclusivi, sono questi i leit-motiv ricorrenti in ogni singolo progetto firmato Il Loft: tessuti, arredi, complementi e interior dalle forme pulite e razionali, sempre capaci di stupire ed emozionare.

Un modo di fare design unico che ha portato l'azienda ad essere emblema della qualità made in Italy nel mondo.

A garanzia della progettazione ricercata ed accurata dell'azienda c'è la mente creativa di Giorgio Saporiti, maestro del design e della moda capace di reinterpretare le tendenze del momento in una chiave ironica e raffinata.

Nuovi prodotti dal design innovativo e con cromie ricercate saranno presentati in esclusiva al Salone del Mobile di Milano, per inserirsi perfettamente nella più ampia collezione esistente de Il Loft.

100% Italian design and exclusive materials form the leitmotifs of every single Il Loft project: fabrics, furniture, furnishings and interiors with clean, functional lines that never fail to amaze and kindle emotions. This unique approach to design has transformed Il Loft into an internationally recognised symbol of the best of "Made in Italy" quality.

Guaranteeing the company's sophisticated and meticulously crafted designs is the creative genius of Giorgio Saporiti, a past master at design and fashion who has a flair for interpreting the latest trends with refinement and a tasteful touch of humour. The new innovatively designed products in refined tones will be exclusively unveiled at the International Furniture Fair in Milan, and represent the perfect addition to Il Loft's wider existing collection.



100% ITALIAN
DESIGN AND
EXCLUSIVE
MATERIALS —
A COLLECTION
WITH PALPABLE
SARTORIAL
INSPIRATION

A CREATIVE MIND

GIORGIO SAPORITI

Da bambino, ammirava i colori, suoni e sapori della natura. Da adulto, le opere dei grandi architetti: da Gio Ponti e Marco Zanuso a Frank Lloyd Wright, Mies van der Rohe e Oscar Niemeyer.

La ricerca del Bello, in tutte le sue forme, è quello che anima da sempre Giorgio Saporiti. Architetto e designer innamorato del colore ("senza di esso la vita non esiste") ma anche imprenditore e grande conoscitore di tendenze del design e della moda, Giorgio Saporiti è stato definito un'"inesauribile macchina sforna-idee": il suo mondo di tessuti, arredi, complementi e interior sembra infatti rigenerarsi all'infinito, dando vita a creazioni che sono allo stesso tempo di tendenza e evergreen. Le sue forme razionali e pulite ma capaci di emozionare, le sue cromie che si fondono le une con le altre, i suoi accostamenti spesso azzardati ma sempre capaci di creare un'armonia perfetta sono alla base del successo globale de Il Loft, l'azienda da lui creata nel 1994, il cui marchio è riconosciuto in tutto il mondo come araldo della qualità Made in Italy. La sua ricetta per il successo? "Progettare perché non solo ogni arredo o complemento ma anche ogni spazio sia unico, pensato per il committente a sua immagine e somiglianza. Perché un interior riuscito è uno in cui si è felici di vivere".

"L'ineluttabile ciclo della trasformazione interessa la nostra casa e il mondo attorno a noi. Nell'atto di creazione una cosa mi resta sempre impressa nella mente: occorre raggiungere la perfetta unione con l'interno che costantemente si rinnova".

When he was a little kid, he used to wonder at the colors, sounds and flavors of nature. As an adult, he was stunned by the masterpieces of great architects such as Gio Ponti and Marco Zanuso, or Frank Lloyd Wright, Mies van der Rohe and Oscar Niemeyer.

The search for Beauty, in all its forms, is what has always motivated Giorgio Saporiti. As an architect and a designer, he is in love with colors ("without them, there is no life"); but his multifaceted nature made it possible for him to be, at the same time, also an excellent entrepreneur as well as a living antenna for design and fashion trends. It does not come as a surprise, then, to hear that Giorgio Saporiti is considered by those who know him "an unstoppable ideas generating machine". His world of fabrics, furniture, and interiors actually seems to regenerate itself infinitely and to give life to creations that have the amazing capacity to be at the same time trendy but evergreen. His rational, pure lines are able to bring out emotions, his color palettes mingle one with the other, his couplings are often hazardous but always end up providing a perfect harmony. These are the characteristics that made up the success of the company that Giorgio Saporiti himself created in 1994, Il Loft, a brand that is now universally recognized as a herald of Made in Italy quality.

His recipe for success? "Designing so that all furniture and interior is a reflection of the client's taste and soul. So that he or she is happy to live in it".

"The unavoidable cycle of transformation also challenges our ideas of home. When I create something, I always keep this in mind: interiors will have to be in tune with the ever-changing world around us".

“WHEN I CREATE SOMETHING, I ALWAYS KEEP THIS IN MIND: INTERIORS WILL HAVE TO BE IN TUNE WITH EVERCHANGING WORLDS AROUND US.”

FOTO BY MARCO GAROFALO



CONTENTS —



BEDS

- 10 GINEVRA CULLA
- 14 GPL
- 18 AURORA
- 22 FLOWER CULLA
- 24 FLOWER BABY
- 28 FELIX BABY
- 32 REGENCY BABY
- 34 VIOLA
- 36 VIOLA BABY
- 38 FRANK
- 44 TRENINO
- 46 GINNY

ARMCHAIRS AND CHAIRS

- 50 FLOWER BABY
- 52 VIOLA BABY
- 54 MICIO
- 58 JADA BABY
- 60 DAISY JUNIOR
- 62 TATO BABY

SOFAS AND POUFFS

- 66 SUPER ROY BABY
- 72 FUNGHI BABY

CARPETS

- 76 TAPPETO VOLANTE
- 78 TAPPETO BABY
- 80 TUNNEL

WOODEN FURNITURES

- 84 AURORA
- 86 CILINDRI
- 88 HAKI BABY

90 SPECIAL PROJECTS

110 TECHNICAL DRAWINGS

BEDS —

"IF YOU
CARRY YOUR
CHILDHOOD
WITH YOU,
YOU NEVER
BECOME
OLDER"



GINEVRA

GIORGIO SAPORITI

Culla sagomata con inserti in plexiglass e materasso anti soffocamento, rivestita nei materiali della nostra collezione.

A shaped cot with plexiglass inserts and an antisuffocation mattress, covered with fabrics from our collection.

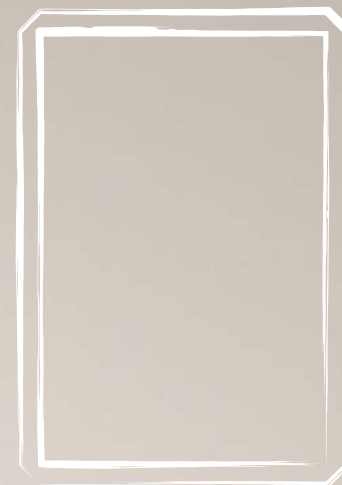



GPL

GIORGIO SAPORITI

Culla sagomata con inserti in plexiglass e materasso anti soffocamento, rivestita nei materiali della nostra collezione.

A shaped cot with plexiglass inserts and an antisuffocation mattress, covered with fabrics from our collection.





AURORA

GIORGIO SAPORITI

Letto interamente imbottito con testata e pediera sagomate con possibilità di avere dei ripari laterali sempre imbottiti e sagomati.

Padded bed with shaped headboard and footboard. Also available with padded and shaped side cabinets.



20 21



AURORA —
BED

IL LOFT

FLOWER CULLA

GIORGIO SAPORITI

Lo schienale della culla, con il suo morbido design a petali, ricorda la forma di un fiore. La struttura è in ferro battuto rivestita in poliuretano espanso indeformabile. I petali, realizzati e sagomati a mano, possono variare leggermente nella forma, facendo quindi di ogni letto un esemplare "unico".

The cot recalls a flower with the soft petal-shaped back. Frame in wrought iron padded in resilient polyurethane foam. The petals are made unique by the manual realization and shaping and can slightly vary in the shape of the petal.



FLOWER BABY

GIORGIO SAPORITI

Lo schienale del letto, con il suo morbido design a petali, ricorda la forma di un fiore. La struttura è in ferro battuto rivestita in poliuretano espanso indeformabile. I petali, realizzati e sagomati a mano, possono variare leggermente nella forma, facendo quindi di ogni letto un esemplare "unico".

The bed recalls a flower with the soft petal-shaped back. Frame in wrought iron padded in resilient polyurethane foam. The petals are made unique by the manual realization and shaping and can slightly vary in the shape of the petal.





FELIX BABY

GIORGIO SAPORITI

Letto rotondo, la testata è composta da due elementi curvilinei, realizzato nei tessuti e pelle della nostra collezione.

The headboard of this round bed is made of two curved parts and it is covered in fabrics and leather from our collection.





REGENCY BABY

GIORGIO SAPORITI

Letto con boxspring singoli con struttura metallica imbottita in gomma uretanica indeformabile. Testata curva sovrapposta a due profondità con cuscini.

Bed with individual box-springs with a metal structure padded with resilient urethane foam. A curved headboard overlapped in two depths with cushions.



VIOLA

GIORGIO SAPORITI

Lo schienale del letto con il suo morbido design a petali ricorda la forma di un fiore.
Il letto può avere anche la pediera e ripari laterali.

With its petal-shaped design, the headboard of the bed is reminiscent of a flower.
The bed is also available with a footboard and side cabinets.



VIOLA BABY

GIORGIO SAPORITI

Letto rotondo con la testata a petali che ricordano la forma di un fiore. Il letto può essere realizzato solo con la testata oppure con l'aggiunta della pediera.

A round bed with a petal-shaped headboard which is reminiscent of a flower. The bed is available with either just a headboard or with a headboard and footboard.



FRANK

GIORGIO SAPORITI







TRENINO

GIORGIO SAPORITI



GINNY

GIORGIO SAPORITI



ARMCHAIRS AND CHAIRS —

"ALICE:
HOW LONG IS
FOREVER?
WHITE RABBIT:
SOMETIMES,
JUST ONE
SECOND."



FLOWER BABY

GIORGIO SAPORITI

Poltrona che richiama il fiore con la sua morbida forma a petali dello schienale. La struttura è in ferro battuto rivestita in poliuretano espanso indeformabile. Ogni poltrona è resa unica perché realizzata e sagomata manualmente e può variare leggermente nella forma dei petali.

Easychair that recalls a flower with the soft petal shaped back. Frame in wrought iron padded in resilient polyurethane foam. Every easychair is made unique by the manual realization and shaping and can slightly vary in petal shape.



VIOLA BABY

GIORGIO SAPORITI

Poltrona e Chaise longue che richiamano un fiore con la sua morbida forma a petali dello schienale.

With their gently petal-shaped backs, this armchair and chaise longue are reminiscent of a flower.



MICIO

GIORGIO SAPORITI





JADA BABY

GIORGIO SAPORITI

Poltroncina imbottita avvolgente con parti metalliche cromate realizzata con tessuti e pelli della nostra collezione.

Enveloping small upholstered armchair, made with fabric and leather from our collection, with chromiumplated metal parts.



DAISY JUNIOR

GIORGIO SAPORITI

Pouff e Poltroncina con struttura avvolgente cromata con cuscino a fiore rivestita con i tessuti nella nostra collezione.

A Pouff and Chair with a chrome-plated, enveloping structure and a flower cushion covered with fabrics from our collection.



TATO BABY

GIORGIO SAPORITI



SOFAS AND POUFFS —

"ALL GROWN-
UPS WERE
ONCE
CHILDREN...
BUT ONLY
FEW OF THEM
REMEMBER IT."

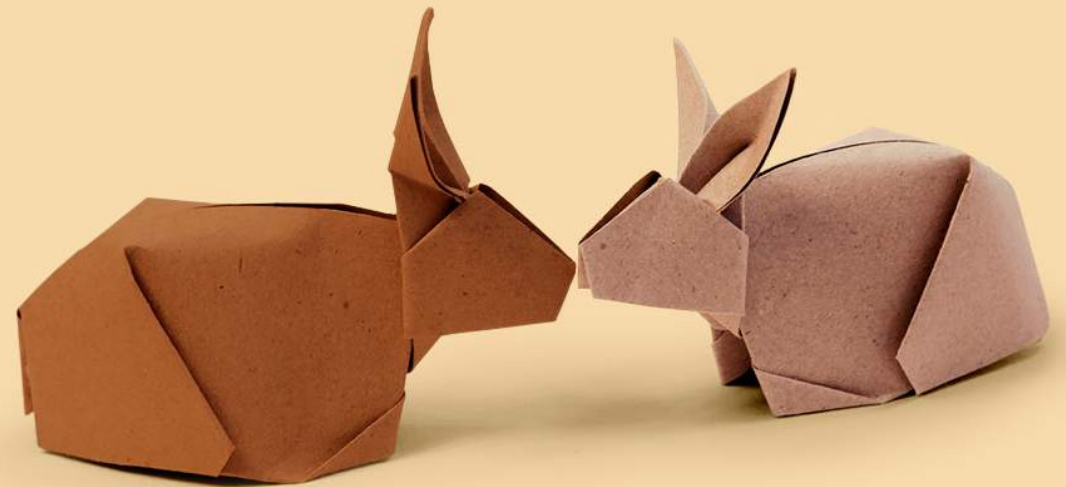

SUPER ROY BABY

GIORGIO SAPORITI

Divano con braccioli di serie, struttura metallica imbottita in gomma uretanica indeformabile. Schienali curvi sovrapposti, a due profondità differenziate per un diverso comfort di seduta. Il taglio in diagonale dei cuscini di seduta si raccorda con la particolare forma dei cuscini degli schienali. I braccioli possono essere realizzati nei materiali della nostra collezione.

Sofas with standard arms, steel frames padded with resilient polyurethane foam. Overlapping curved backs which provide two different seating depths for better comfort. The diagonal cut of the seat cushions is in harmony with the shape of the back cushions. Arms in coverings of our collection.







FUNGHI BABY

GIORGIO SAPORITI

Serie di pouff imbottiti di varie forme e dimensioni. Rivestimento con vari tipi di tessuto, pelle o microfibra della nostra collezione.

A series of padded footstools in various shapes and sizes. Covered with fabrics, leather or microfibres from our collection.



CARPETS —

"PLAY IS
THE WORK
OF
CHILDHOOD."



TAPPETO VOLANTE

GIORGIO SAPORITI



TAPPETO BABY

GIORGIO SAPORITI



TUNNEL

GIORGIO SAPORITI



WOODEN FURNITURES —

"FANTASY,
INVENTION,
CREATIVITY
THINK.
IMAGINATION
SEES."

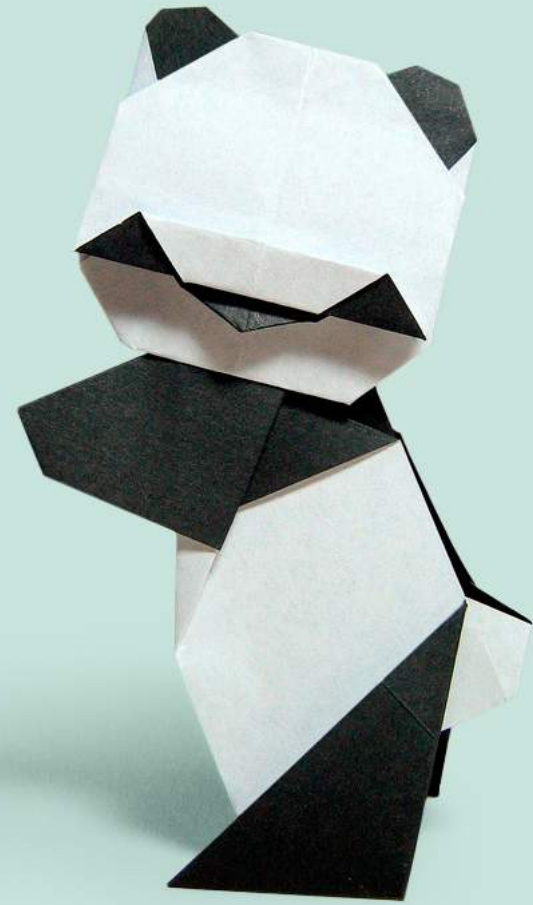

AURORA

GIORGIO SAPORITI



CILINDRI

GIORGIO SAPORITI



HAKI BABY

GIORGIO SAPORITI

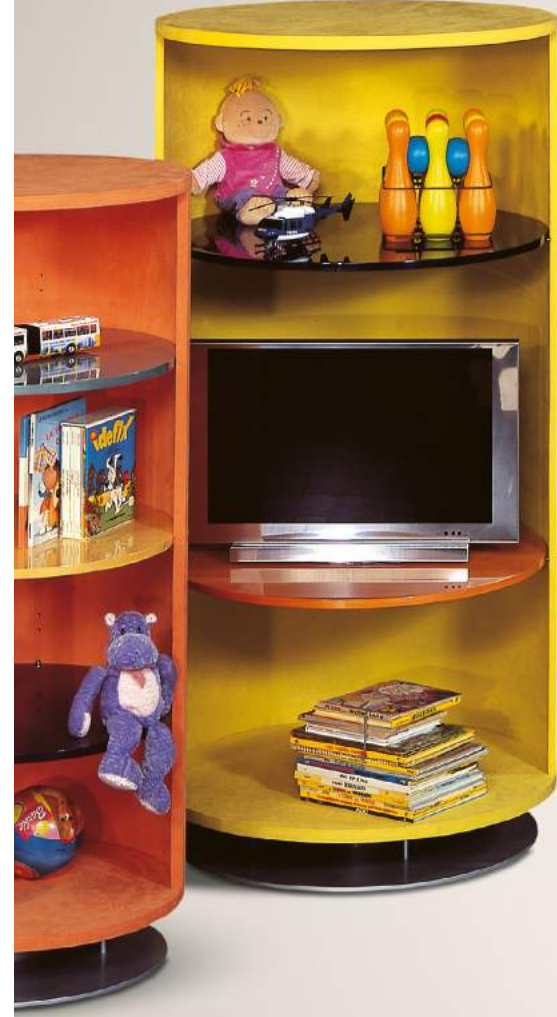

SPECIAL PROJECTS —

"EVERY
ADVENTURES
REQUIRES
A FIRST
STEP."









96 97

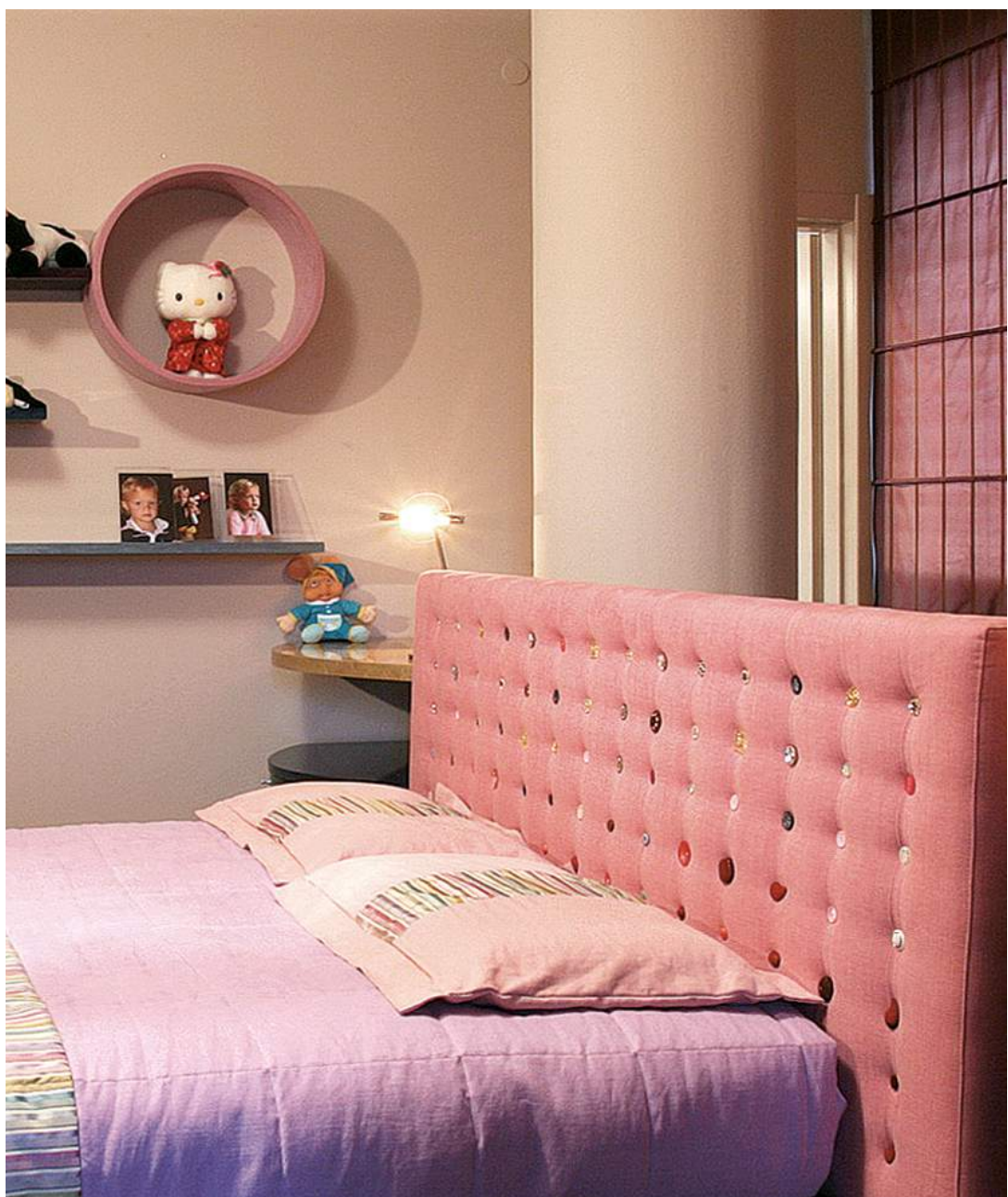

SPECIAL PROJECTS

IL LOFT





102 103







IMBOTTITI / SOFAS

SUPER ROY BABY

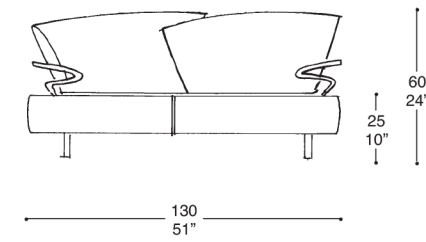

SR 218

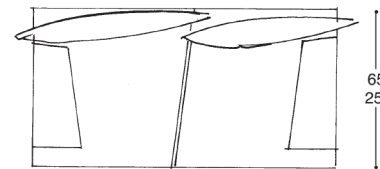

SUPER ROY BABY ESECUZIONE SPECIALE

SR 219

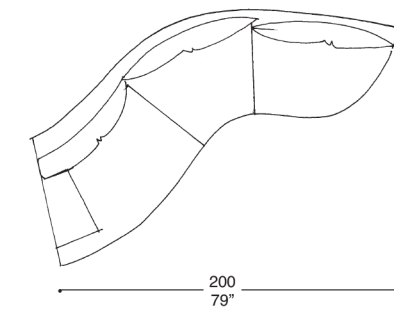

SR 220

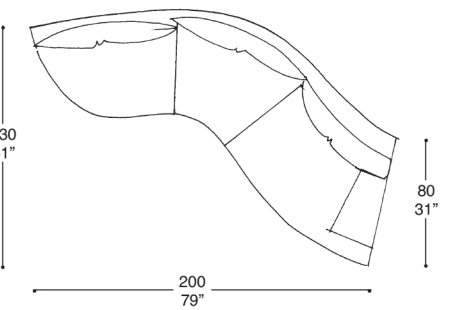

POLTRONE / ARMCHAIRS

FLOWER BABY

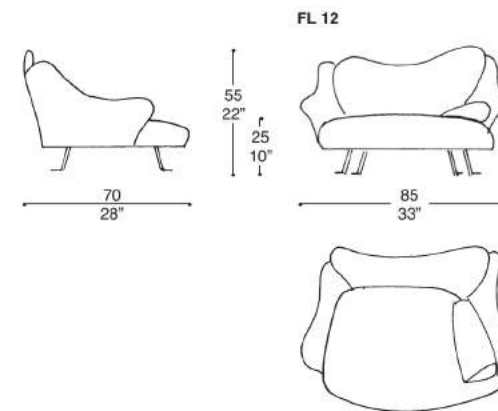

JADA BABY

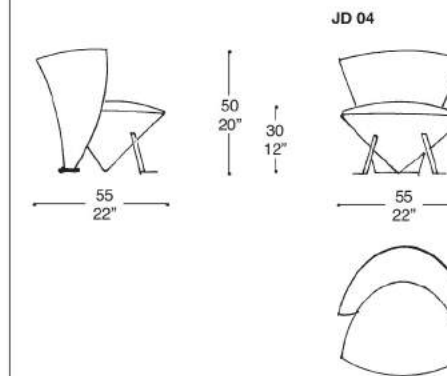

VIOLA BABY

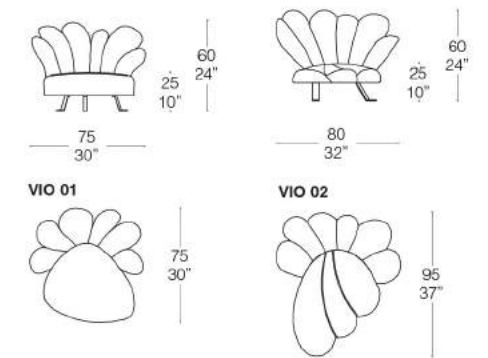

MICIO

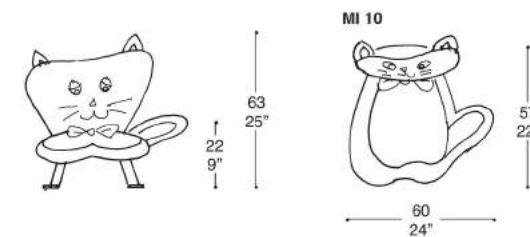

SEDIE / CHAIRS

TATO BABY



TATO 02

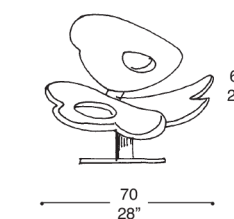

POUFF / POUFS

FUNGHI BABY

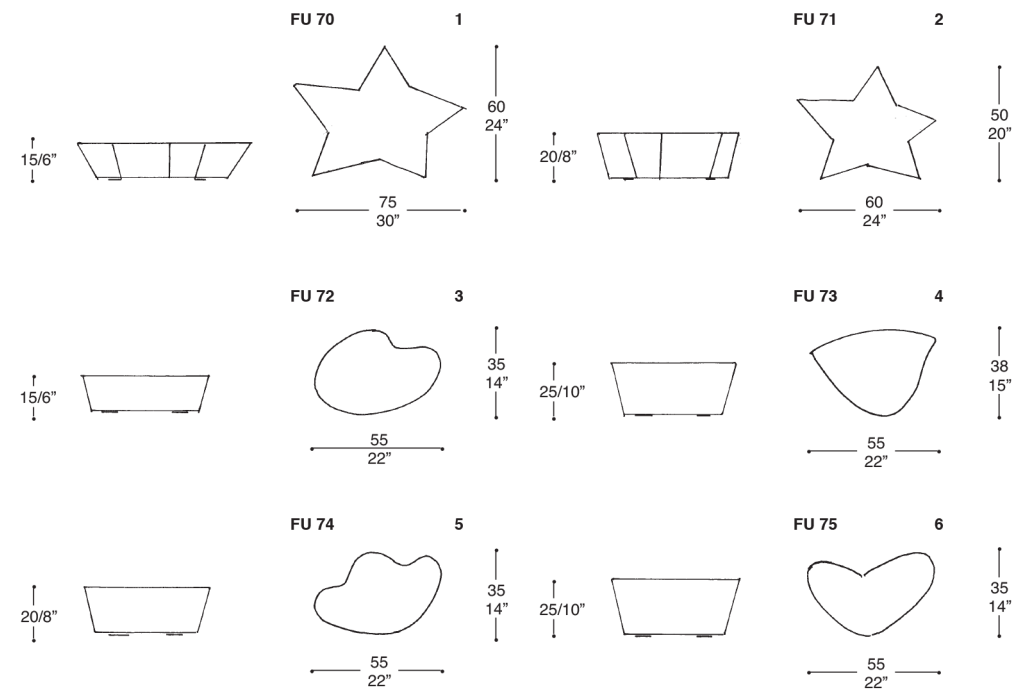

DAYSY JUNIOR POUFF

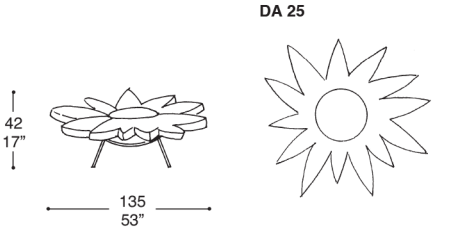

DAYSY JUNIOR POLTRONCINA

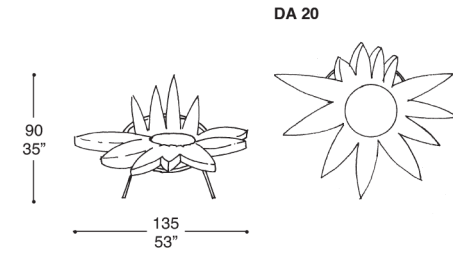

CUSCINI / PILLOWS

ZOOM

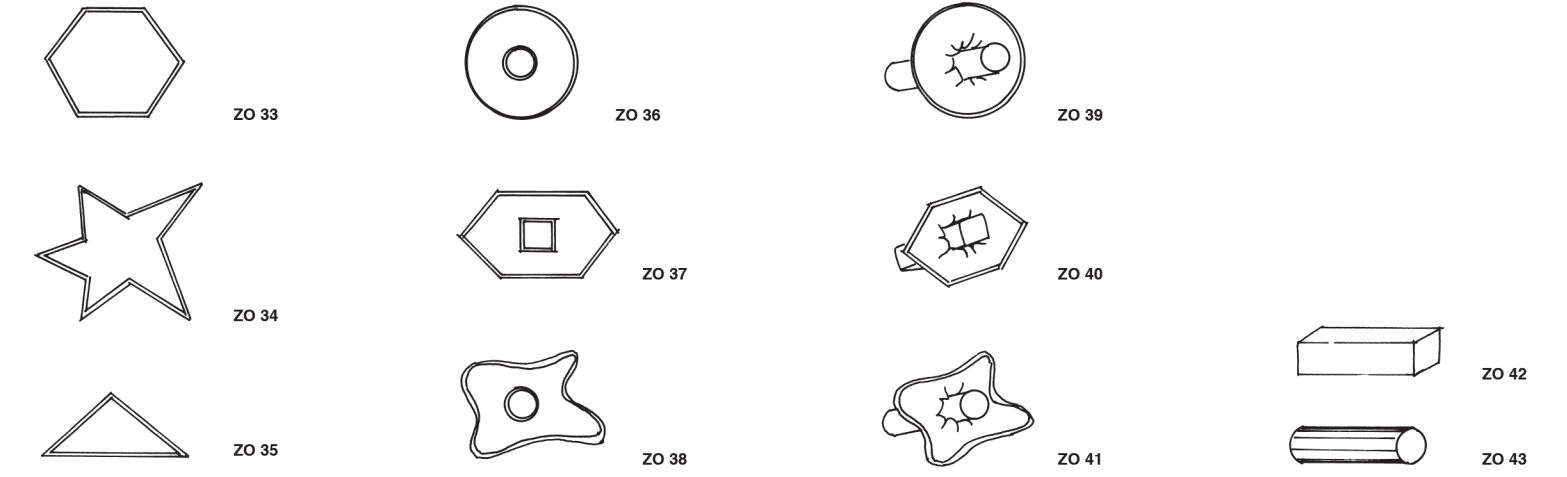

CUSCINI / PILLOWS

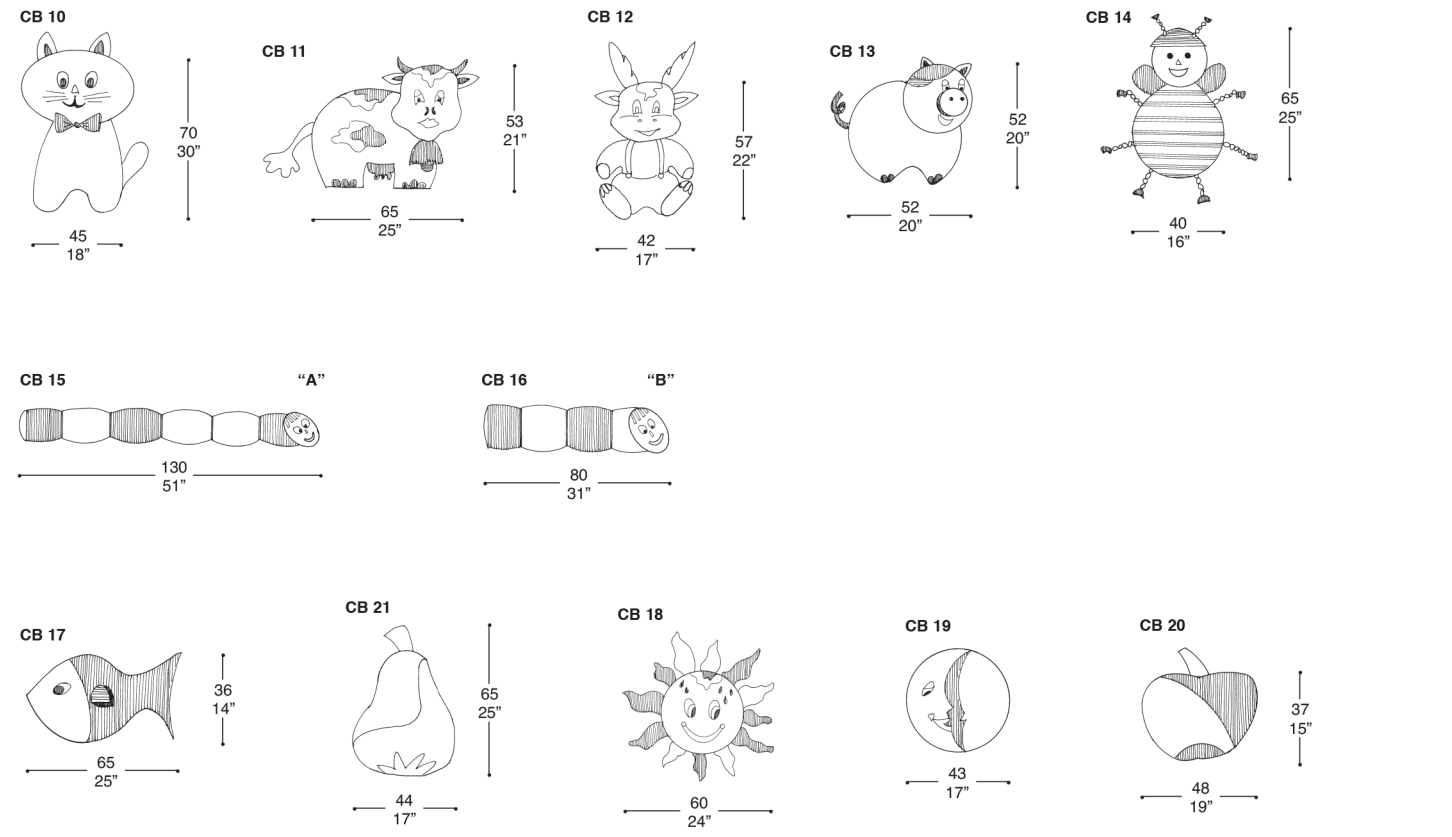

LETTI / BEDS

AURORA

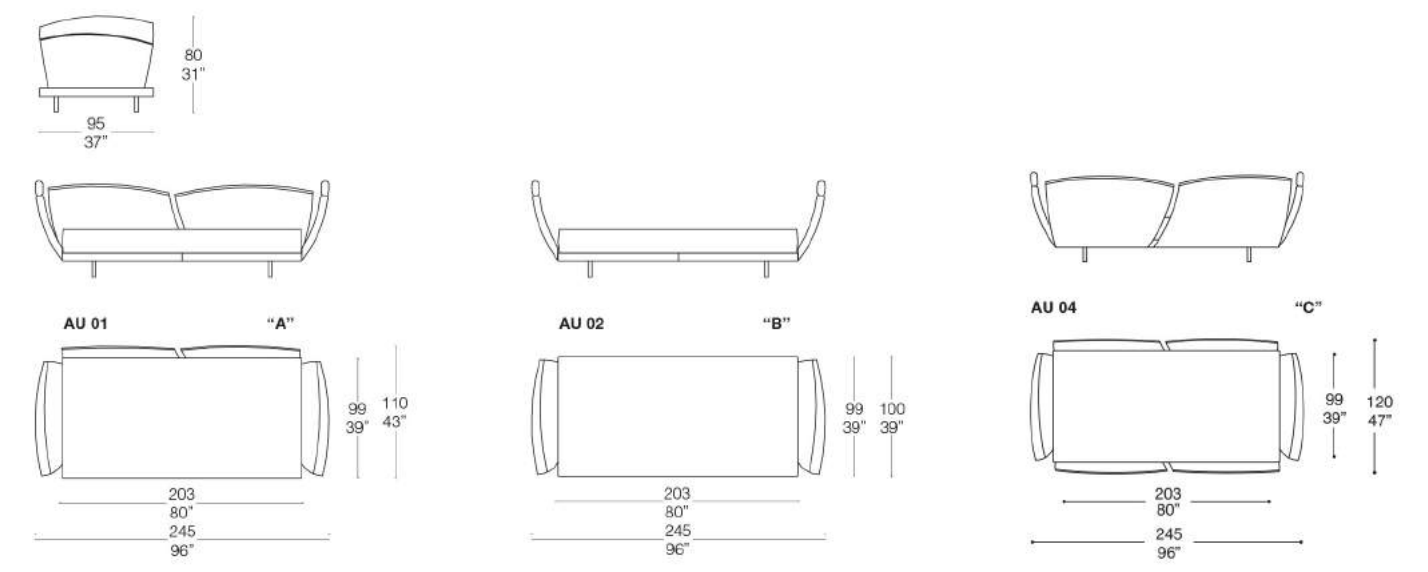

FLOWER BABY

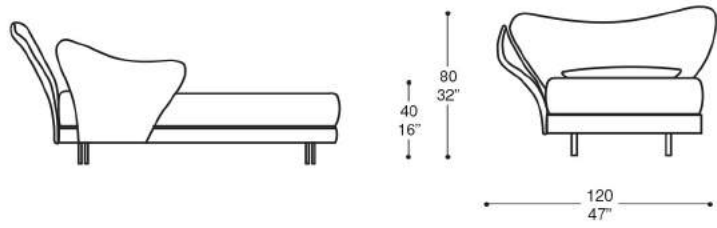

LF 05

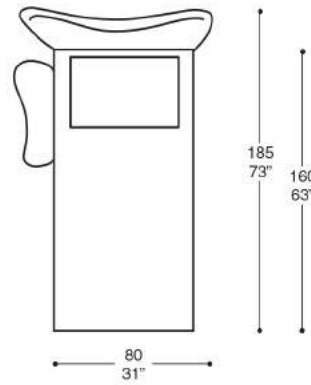

LF 06

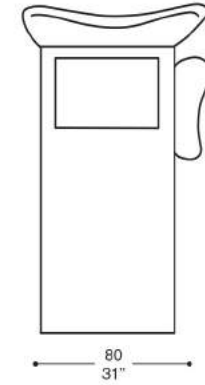

LF 04

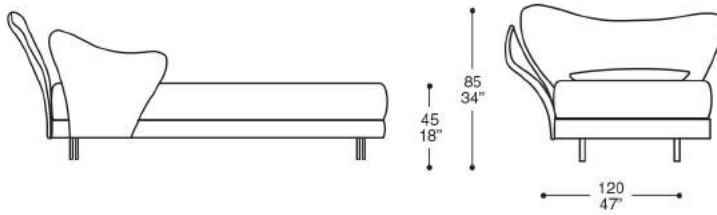
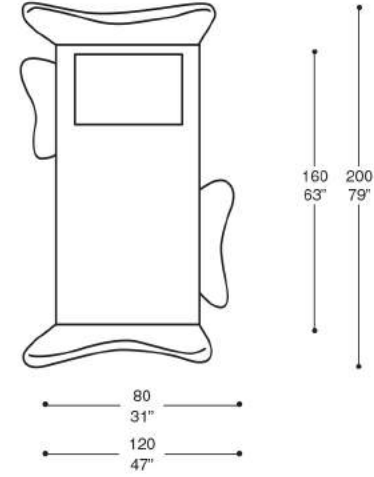

LF 11

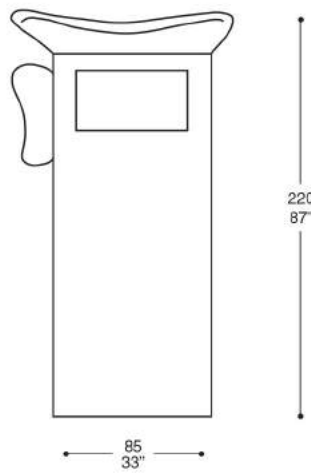

LF 12

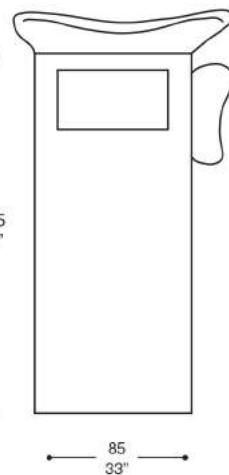

LF 10

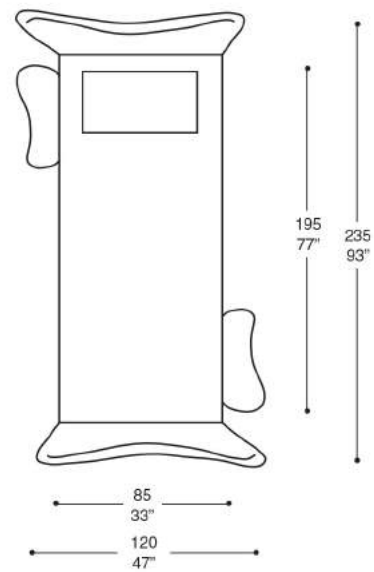

FLOWER CULLA

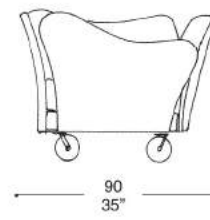

LF 08

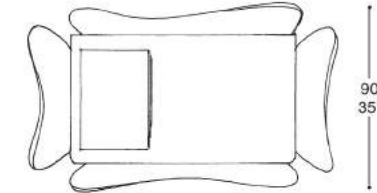
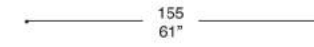

115 x 65 / 45" x 26"
MATERASSO
MATTRESS

GINEVRA CULLA

LF 27

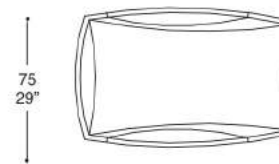
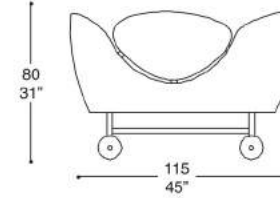

GPL CULLA

GPL 01

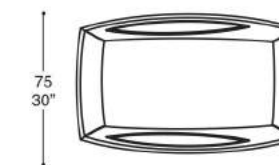
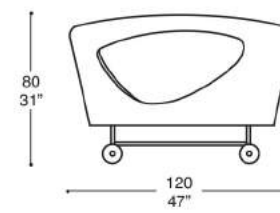

FELIX BABY

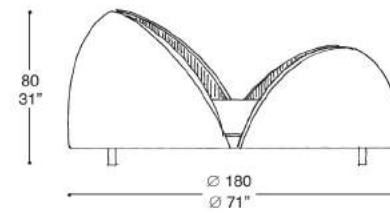

LF 36

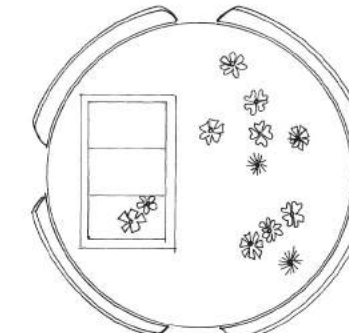

∅ 160 / 63"
MATERASSO
MATTRESS

FRANK

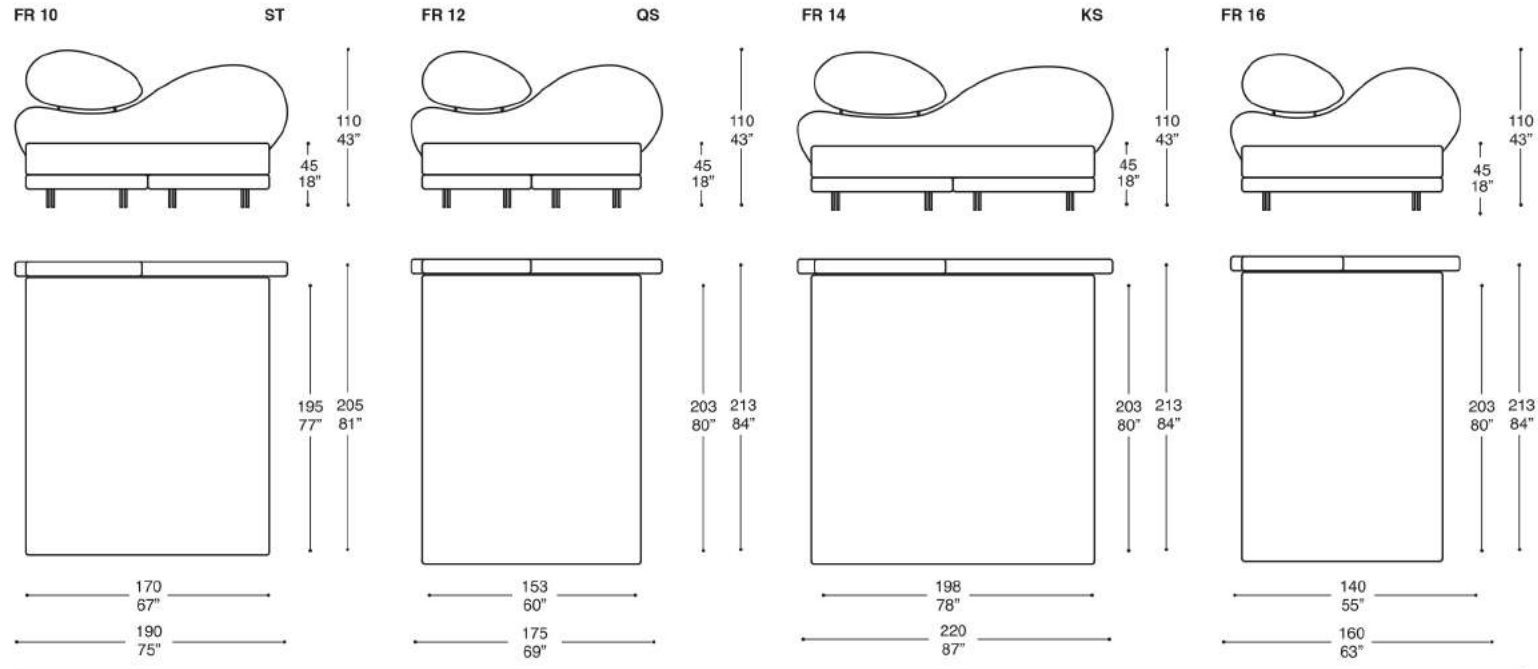

REGENCY BABY

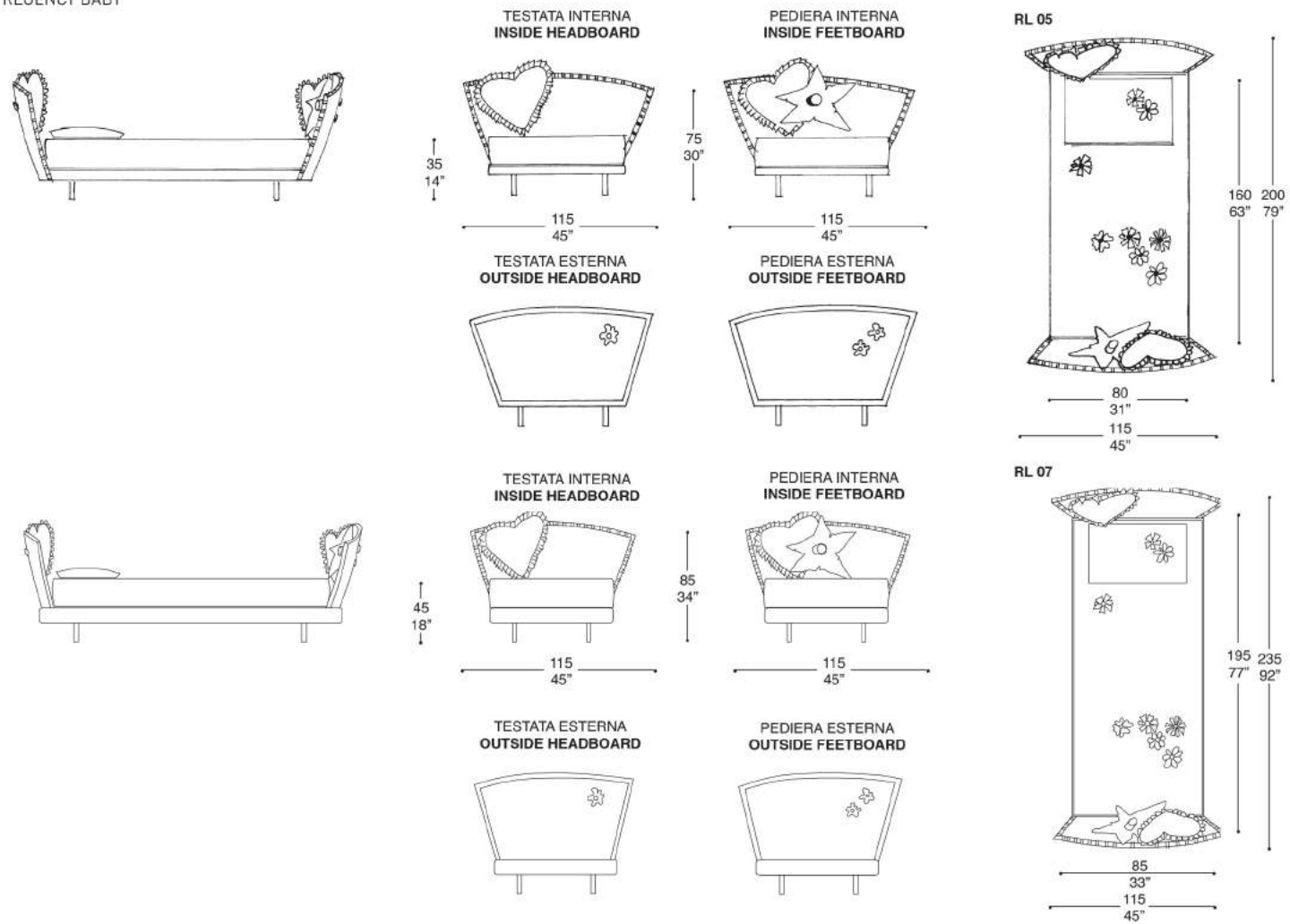

VIOLA BABY

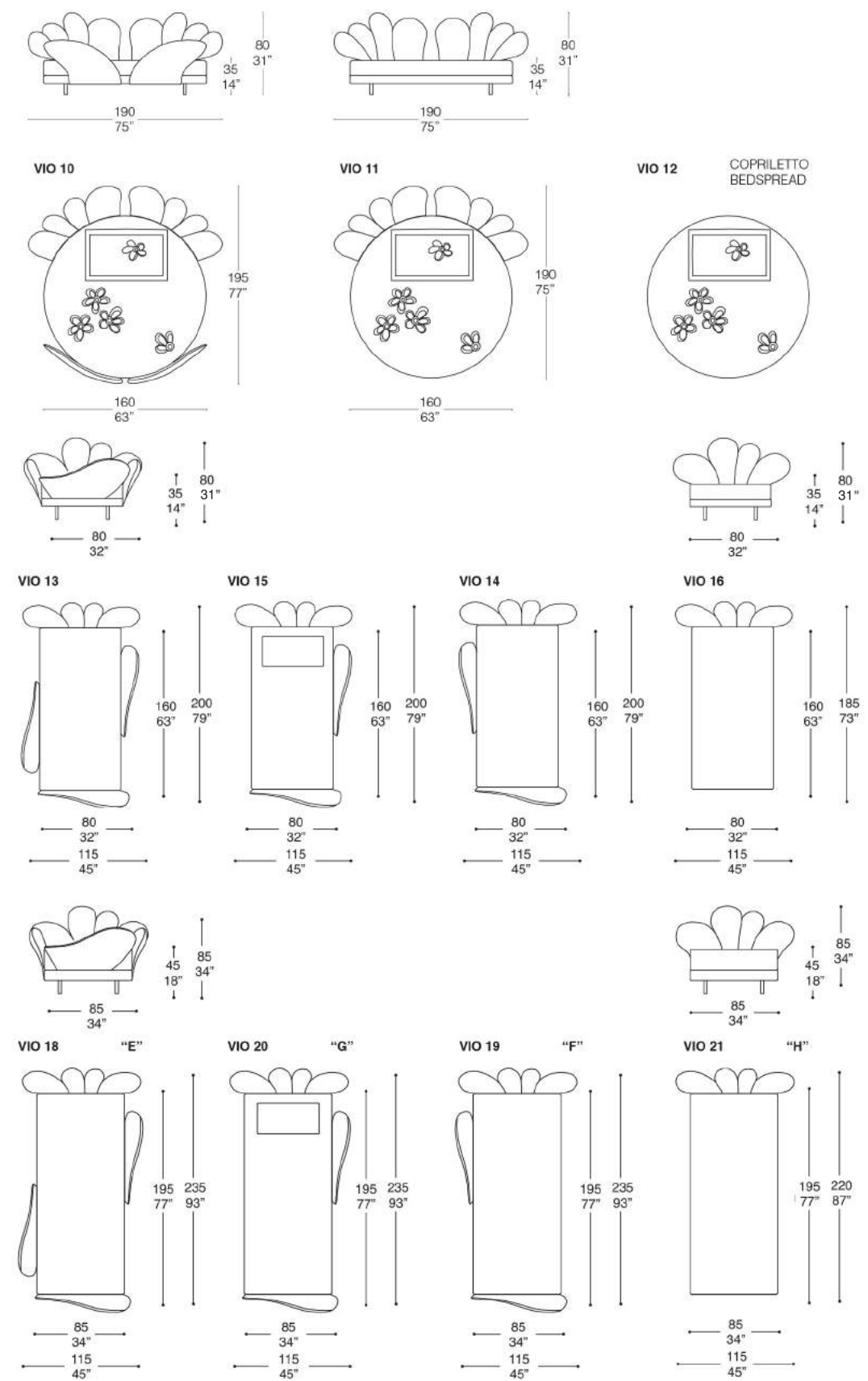

TRENINO BABY

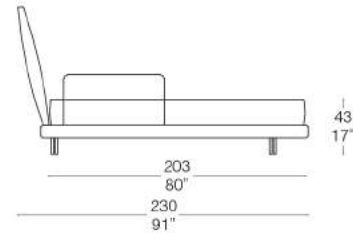
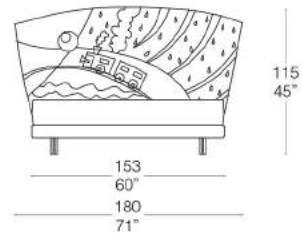

TRE 01

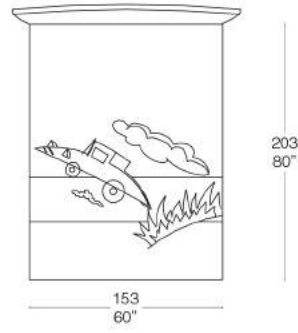

TRE 02 COPRILETTO BEDSPREAD

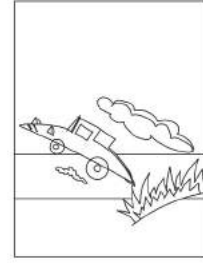

TRE 03

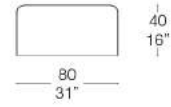

MOBILI / FURNITURES

AURORA

AU 10

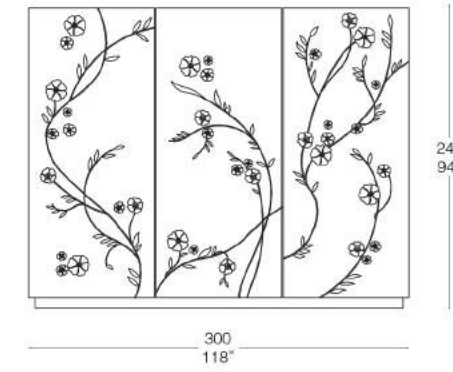

Ante scorrevoli / Sliding doors



Vista interna / Internal view struttura / frame

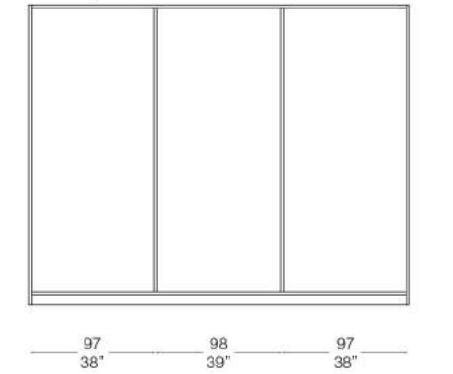

AU 11

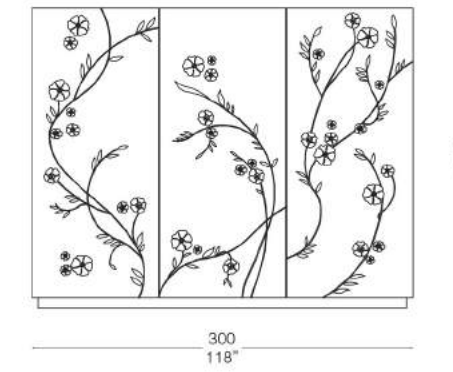

Ante complanari / Complanar doors



Vista interna / Internal view struttura / frame

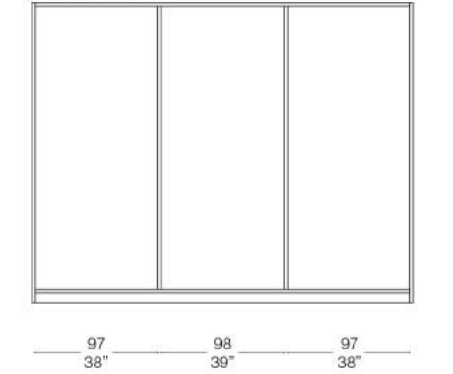

AU 12

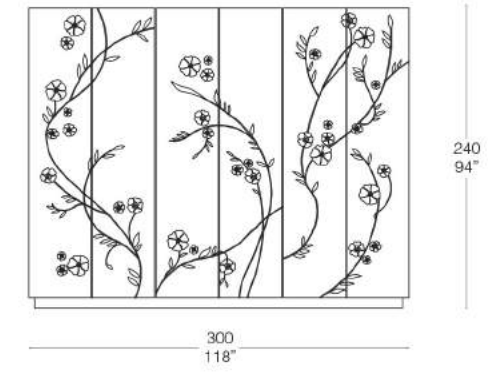

Ante battenti / Hinged doors



Vista interna / Internal view struttura / frame

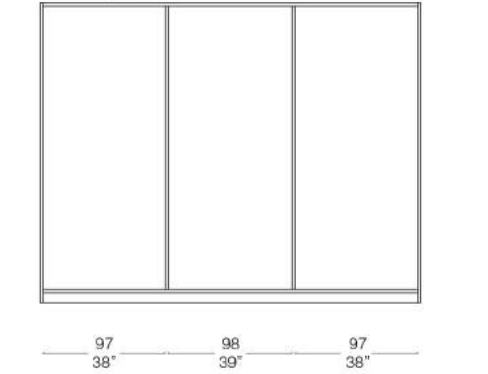

AU 13

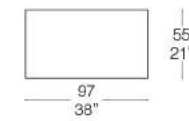

AU 14 SX

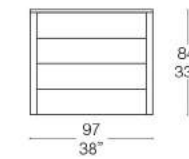

AU 16

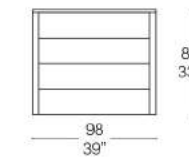

AU 15 DX

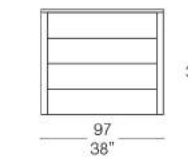

AU 17 SX

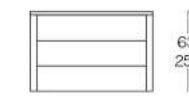

AU 19

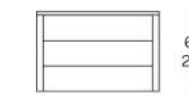

AU 18 DX



AU 20 SX

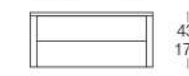

AU 22

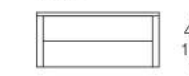

AU 21 DX

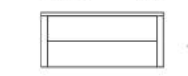

AU 23



AU 24



CILINDRI

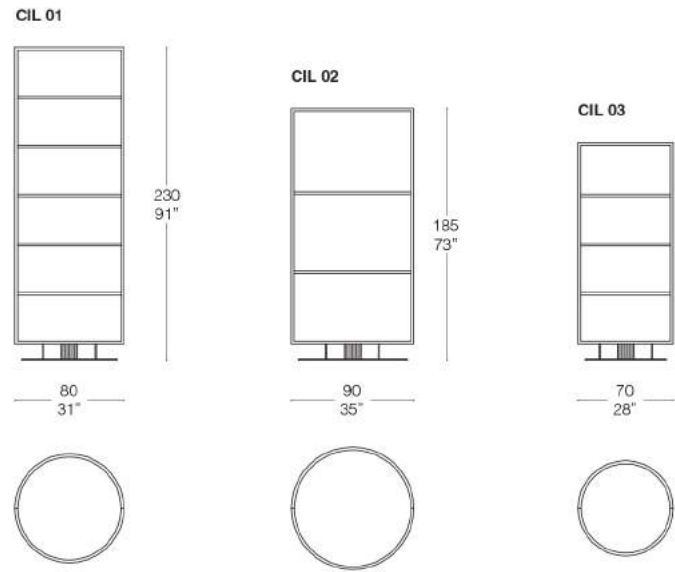

HAKI BABY

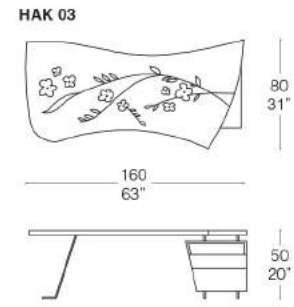

TAPPETI / CARPETS

TAPPETO VOLANTE

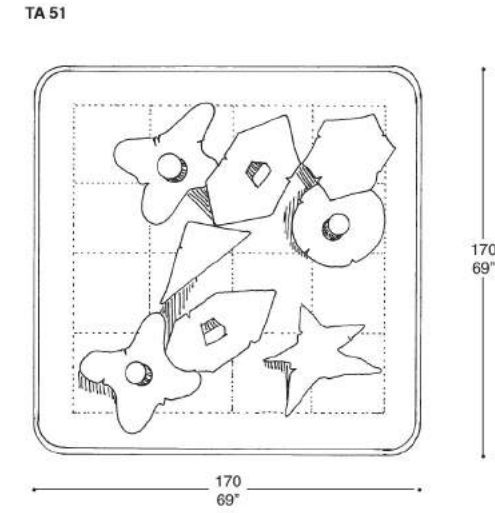

TAPPETO BABY

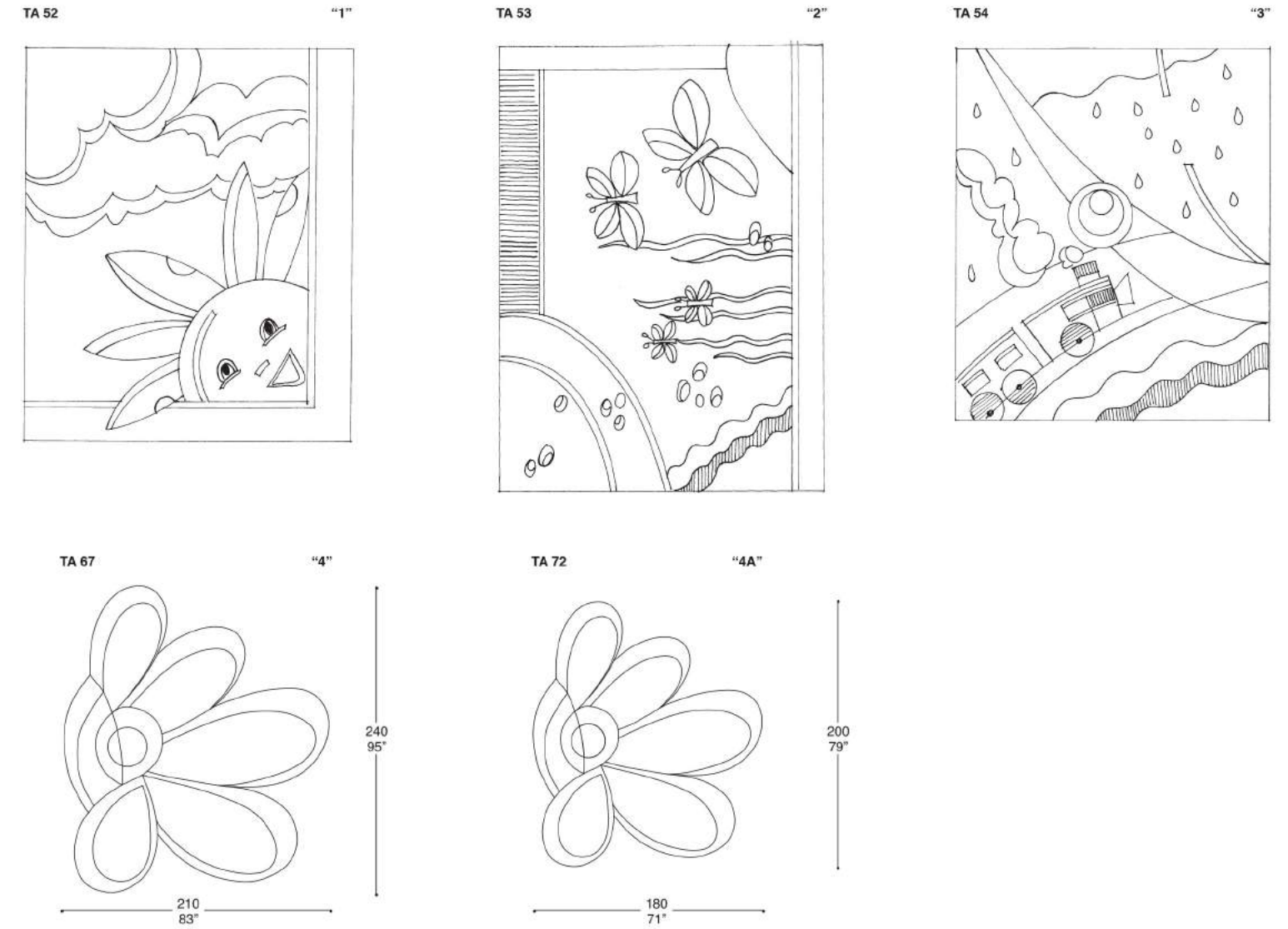

TUNNEL

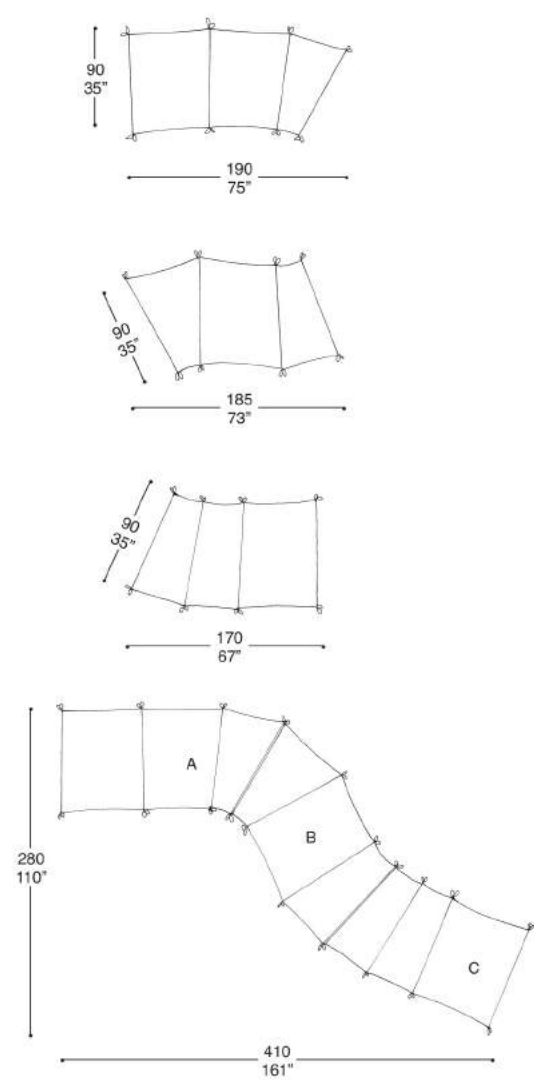

TU 01 "A"

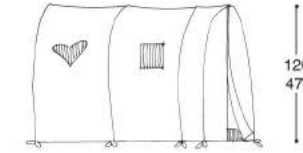

TU 02 "B"

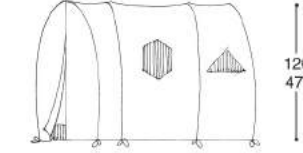

TU 03 "C"

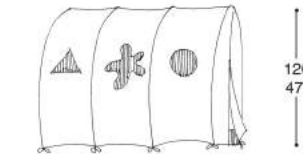

TU 04

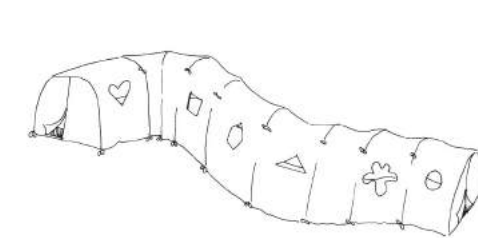



Credits—

AD—
GS+KB

Graphic Design—
Byung Soo Zocchi
Blackspace

Photo—
Giorgio Saporiti jr

Printed in Italy by
AGF S.p.A.
March 2018

I colori dei tessuti, delle pelli e dei legni
delle nostre realizzazioni fotografate
su questo catalogo, possono non essere
perfettamente riprodotti in stampa—
The reproduction of the colours of our
fabrics, leather and wood photographed
in this catalogue may vary slightly from
the original shade due to printing.

