

OUTDOORCOLLECTION



Il Loft

Il Loft

A UNIQUE APPROACH — IL LOFT

Design 100% italiano e materiali esclusivi, sono questi i leit-motiv ricorrenti in ogni singolo progetto firmato Il Loft: tessuti, arredi, complementi e interior dalle forme pulite e razionali, sempre capaci di stupire ed emozionare.

Un modo di fare design unico che ha portato l'azienda ad essere emblema della qualità made in Italy nel mondo.

A garanzia della progettazione ricercata ed accurata dell'azienda c'è la mente creativa di Giorgio Saporiti, maestro del design e della moda capace di reinterpretare le tendenze del momento in una chiave ironica e raffinata.

Nuovi prodotti dal design innovativo e con cromie ricercate saranno presentati in esclusiva al Salone del Mobile di Milano, per inserirsi perfettamente nella più ampia collezione esistente de Il Loft.

100% Italian design and exclusive materials form the leitmotifs of every single Il Loft project: fabrics, furniture, furnishings and interiors with clean, functional lines that never fail to amaze and kindle emotions. This unique approach to design has transformed Il Loft into an internationally recognised symbol of the best of "Made in Italy" quality.

Guaranteeing the company's sophisticated and meticulously crafted designs is the creative genius of Giorgio Saporiti, a past master at design and fashion who has a flair for interpreting the latest trends with refinement and a tasteful touch of humour. The new innovatively designed products in refined tones will be exclusively unveiled at the International Furniture Fair in Milan, and represent the perfect addition to Il Loft's wider existing collection.



100% ITALIAN
DESIGN AND
EXCLUSIVE
MATERIALS —
A COLLECTION
WITH PALPABLE
SARTORIAL
INSPIRATION

A CREATIVE MIND

GIORGIO SAPORITI

Da bambino, ammirava i colori, suoni e sapori della natura. Da adulto, le opere dei grandi architetti: da Gio Ponti e Marco Zanuso a Frank Lloyd Wright, Mies van der Rohe e Oscar Niemeyer.

La ricerca del Bello, in tutte le sue forme, è quello che anima da sempre Giorgio Saporiti. Architetto e designer innamorato del colore ("senza di esso la vita non esiste") ma anche imprenditore e grande conoscitore di tendenze del design e della moda, Giorgio Saporiti è stato definito un "inesauribile macchina sforna-idee": il suo mondo di tessuti, arredi, complementi e interior sembra infatti rigenerarsi all'infinito, dando vita a creazioni che sono allo stesso tempo di tendenza e evergreen. Le sue forme razionali e pulite ma capaci di emozionare, le sue cromie che si fondono le une con le altre, i suoi accostamenti spesso azzardati ma sempre capaci di creare un'armonia perfetta sono alla base del successo globale de Il Loft, l'azienda da lui creata nel 1994, il cui marchio è riconosciuto in tutto il mondo come araldo della qualità Made in Italy. La sua ricetta per il successo? "Progettare perché non solo ogni arredo o complemento ma anche ogni spazio sia unico, pensato per il committente a sua immagine e somiglianza. Perché un interior riuscito è uno in cui si è felici di vivere".

"L'ineluttabile ciclo della trasformazione interessa la nostra casa e il mondo attorno a noi. Nell'atto di creazione una cosa mi resta sempre impressa nella mente: occorre raggiungere la perfetta unione con l'interno che costantemente si rinnova".

When he was a little kid, he used to wonder at the colors, sounds and flavors of nature. As an adult, he was stunned by the masterpieces of great architects such as Gio Ponti and Marco Zanuso, or Frank Lloyd Wright, Mies van der Rohe and Oscar Niemeyer.

The search for Beauty, in all its forms, is what has always motivated Giorgio Saporiti. As an architect and a designer, he is in love with colors ("without them, there is no life"); but his multifaceted nature made it possible for him to be, at the same time, also an excellent entrepreneur as well as a living antenna for design and fashion trends. It does not come as a surprise, then, to hear that Giorgio Saporiti is considered by those who know him "an unstoppable ideas generating machine". His world of fabrics, furniture, and interiors actually seems to regenerate itself infinitely and to give life to creations that have the amazing capacity to be at the same time trendy but evergreen. His rational, pure lines are able to bring out emotions, his color palettes mingle one with the other, his couplings are often hazardous but always end up providing a perfect harmony. These are the characteristics that made up the success of the company that Giorgio Saporiti himself created in 1994, Il Loft, a brand that is now universally recognized as a herald of Made in Italy quality.

His recipe for success? "Designing so that all furniture and interior is a reflection of the client's taste and soul. So that he or she is happy to live in it".

"The unavoidable cycle of transformation also challenges our ideas of home. When I create something, I always keep this in mind: interiors will have to be in tune with the ever-changing world around us".

“WHEN I CREATE SOMETHING, I ALWAYS KEEP THIS IN MIND: INTERIORS WILL HAVE TO BE IN TUNE WITH EVERCHANGING WORLDS AROUND US.”

FOTO BY MARCO GAROFALO



CONTENTS —

08	NIKOS SOFA
18	SUPER ROY SOFA
36	FLOWER ARMCHAIR
38	SUPER ROY ARMCHAIR
40	JADA ARMCHAIR
42	GEORGE ARMCHAIR
50	SQUARE TABLE
55	TECHNICAL DRAWINGS



NIKOS

GIORGIO SAPORITI

Divano componibile con struttura in metallo verniciata dove vengono appoggiati comodi cuscini di seduta e schienale. La serie comprende anche Poltrona, Chaise Lounge, pouff e tavolini e il prodotto può essere usato sia per ambienti interni che esterni utilizzando tessuti e materiale della collezione Home o della collezione Outdoor.

A modular sofa with comfortable seat and back cushions on a lacquered steel frame. The series also includes an armchair, chaise longue, pouf, and low tables and can be featured in indoor and outdoor spaces using fabrics and materials chosen from the Home Collection or the Outdoor Collection.







12 13

NIKOS —
SOFA

IL LOFT





16 17

NIKOS —
SOFA

IL LOFT

SUPER ROY

GIORGIO SAPORITI

Divano lineare, angolare e sagomato con struttura e piedi in acciaio inox. Gli Schienali curvi sono sovrapposti a due profondità differenziate per un diverso comfort di seduta. Il taglio in diagonale dei cuscini di seduta si raccorda con la particolare forma dei cuscini degli schienali. I divani possono essere rivestiti con i tessuti della nostra collezione outdoor che sono antistatici, inattaccabili da muffe e batteri e impermeabili all'acqua. È inoltre disponibile il winter set impermeabile e anti muffa.

Shaped linear or corner sofa with a stainless steel frame and feet. Overlapping curved backs provide two different seating depths for enhanced comfort. The diagonally cut design of the seat cushions harmonises with the unique shape of the back cushions. The sofas can be covered with fabrics from our outdoor collection, which are antistatic, waterproof and resistant to mould and bacteria. Our waterproof and mould-proof winter set is also available.















30 31

SUPER ROY —
SOFA

IL LOFT



"WE LOOK
FOR OUR-
SELVES
THROUGH
THIS
RELENTLESS
SEARCH
FOR WHAT
IS NEW."

GIORGIO SAPORITI



FLOWER

GIORGIO SAPORITI

Poltrona che richiama il fiore con la sua morbida forma a petali dello schienale. La struttura è in acciaio inox e resa unica, perché realizzata e sagomata manualmente pertanto può variare leggermente nella forma dei petali. È possibile rivestire la poltrona con i tessuti della nostra collezione outdoor che sono antistatici, inattaccabili da muffe e batteri e impermeabili all'acqua. È inoltre disponibile il winter set impermeabile e anti muffa.

With a back featuring soft, petal shapes, this armchair is reminiscent of a flower. The stainless steel frame is utterly unique as it is crafted and shaped by hand so the shape of the petals may vary slightly. The armchair can be covered with fabrics from our outdoor collection, which are antistatic, waterproof and resistant to mould and bacteria. Our waterproof and mouldproof winter set is also available.



SUPER ROY

GIORGIO SAPORITI

Poltrona di forma asimmetrica disponibile in versione con un solo bracciolo posizionabile su uno dei due lati o con due braccioli. Posa testa rigido e trapuntato con rullo imbottito per ottenere il massimo comfort. La poltrona è realizzata con struttura e piedi in acciaio inox e può essere rivestita con i tessuti della nostra collezione outdoor che sono antistatici, inattaccabili da muffe e batteri e impermeabili all'acqua. È inoltre disponibile il winter set impermeabile e anti muffa. È previsto inoltre l'utilizzo di un tavolino d'appoggio laterale in legno.

This asymmetrical armchair is available with one armrest on one side or the other, or with two armrests. The rigid, quilted headrest has a padded bolster cushion to ensure the utmost comfort. The armchair is made with a stainless steel frame and feet, and can be covered with fabrics from our outdoor collection, which are antistatic, waterproof and resistant to mould and bacteria. Our waterproof and mould-proof winter set is also available. This armchair also comes with wooden end table.



JADA

GIORGIO SAPORITI

Poltroncina avvolgente, con struttura e piedi in acciaio inox. Rivestita con i tessuti della nostra collezione outdoor che sono antistatici, inattaccabili da muffe e batteri e impermeabili all'acqua. È inoltre disponibile il winter set impermeabile e anti muffa.

An enveloping easy chair with a stainless steel frame and feet. It is covered with fabrics from our outdoor collection, which are antistatic, waterproof and resistant to mould and bacteria. Our waterproof and mould-proof winter set is also available.



GEORGE

GIORGIO SAPORITI

Chaise longue con struttura e base in acciaio inox con la possibilità di regolare l'inclinazione dello schienale per ottenere il massimo confort. La chaise Longue può essere rivestita con i tessuti della nostra collezione outdoor che sono antistatici, inattaccabili da muffe e batteri e impermeabili all'acqua. E' inoltre disponibile il winter set impermeabile e anti muffa.

Chaise longue with a stainless steel frame and base. The backrest can be angled to ensure the utmost comfort. The chaise longue can be covered with fabrics from our outdoor collection, which are antistatic, waterproof and resistant to mould and bacteria. Our waterproof and mould-proof winter set is also available.



"THE UN-
VOIDABLE
CYCLE OF
TRANSFOR-
MATION
ALSO CHAL-
LENGES
OUR IDEAS
OF HOME."

GIORGIO SAPORITI

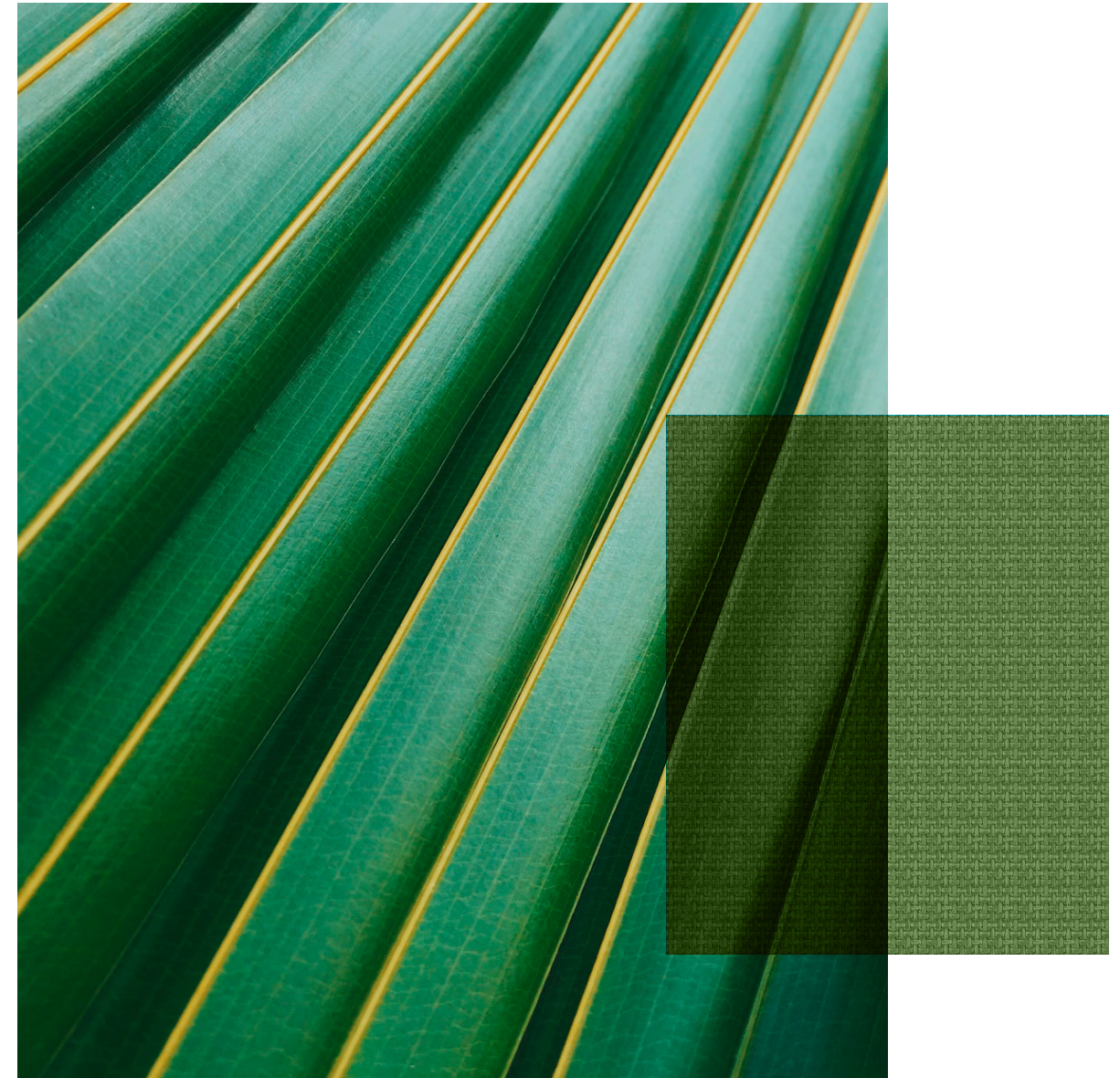



46 47

FLOWER, JADA, GEORGE —
ARMCHAIRS

IL LOFT



48 49

SQUARE

GIORGIO SAPORITI

Tavolo con struttura in acciaio inox e top formato da quadri intercambiabili con mensola centrale, il tutto sempre in acciaio inox verniciato.

Table with a stainless steel frame and a top made of interchangeable squares and a central shelf. The entire table is in lacquered stainless steel.





TECHNICAL DRAWINGS —

NIKOS

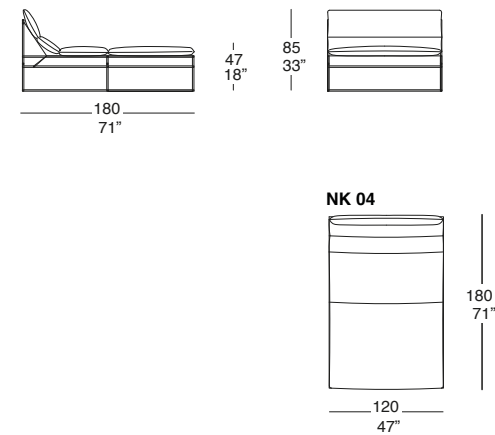
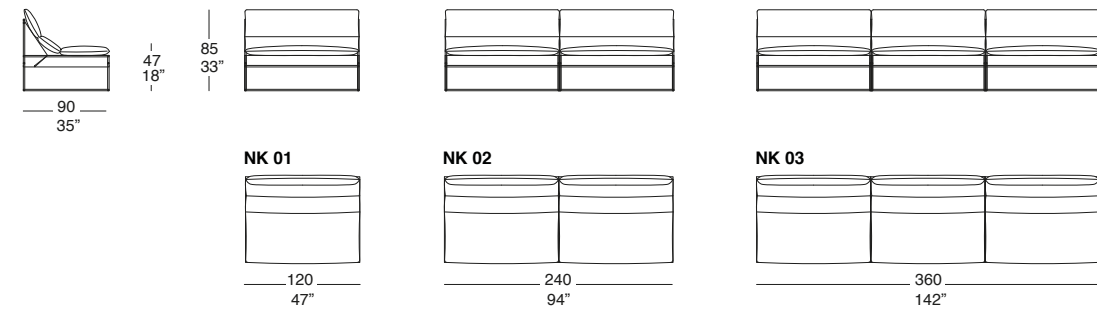

NIKOS

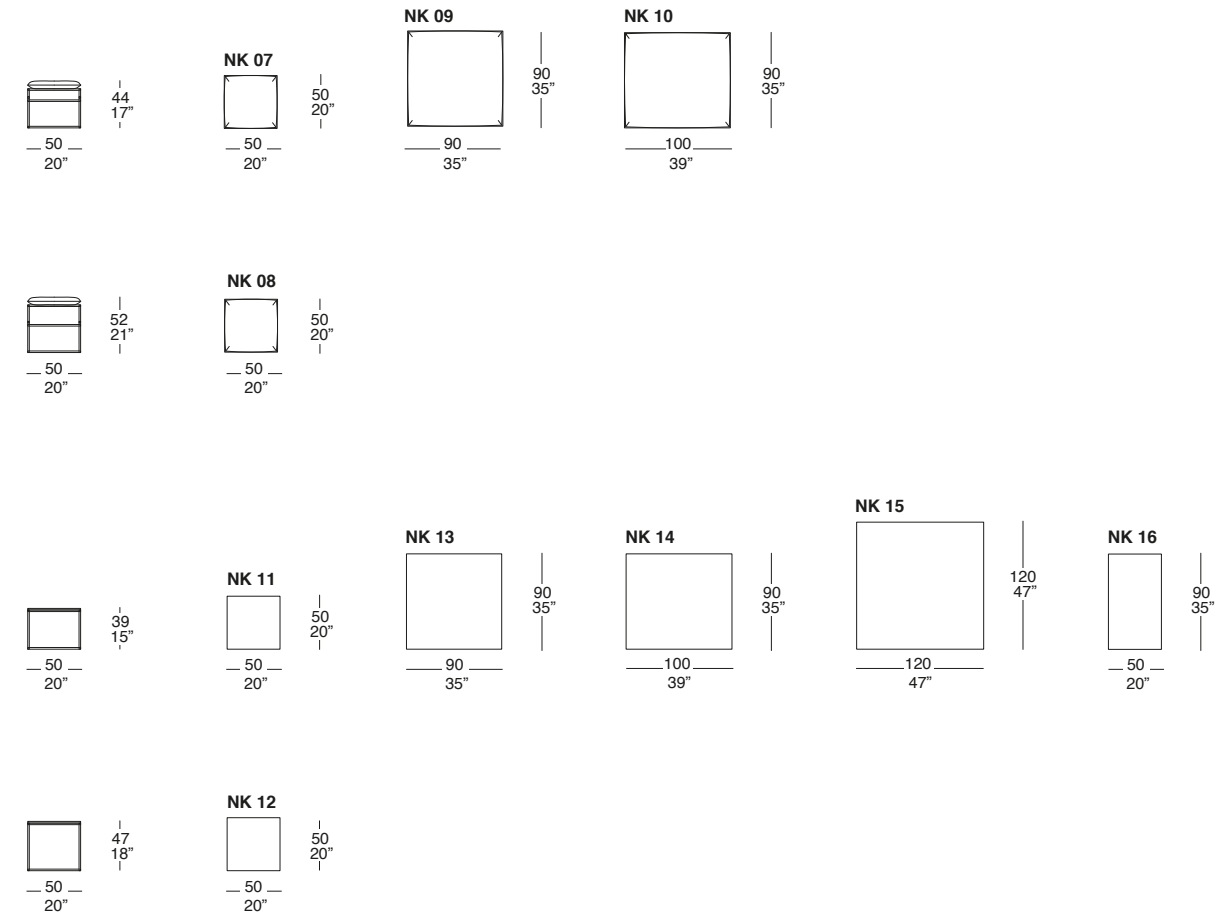

I prodotti della Collezione Outdoor sono stati testati per la collocazione da esterno, l'utilizzo ideale consigliato è per terrazzi e verande ed è buona norma proteggere gli articoli da esterno adottando accorgimenti che consentono di migliorarne la durata. È possibile acquistare l'apposito winter set che consente di proteggere meglio dalle intemperie i prodotti acquistati. Preghiamo accertarsi che tutti i prodotti siano completamente asciutti prima di coprirli per evitare accumuli di umidità o la formazione di macchie di muffa.

The products in the Outdoor Collection have been tested so that may be used outside, ideally on terraces and verandas. Outdoor furniture should receive the correct care and maintenance to extend the life of the product. Il Loft sells the special winter set which enables you to provide the best protection against bad weather for your purchases. Please ensure that all pieces of furniture are completely dry before covering them to prevent damp patches or the formation of mould stains.

NIKOS

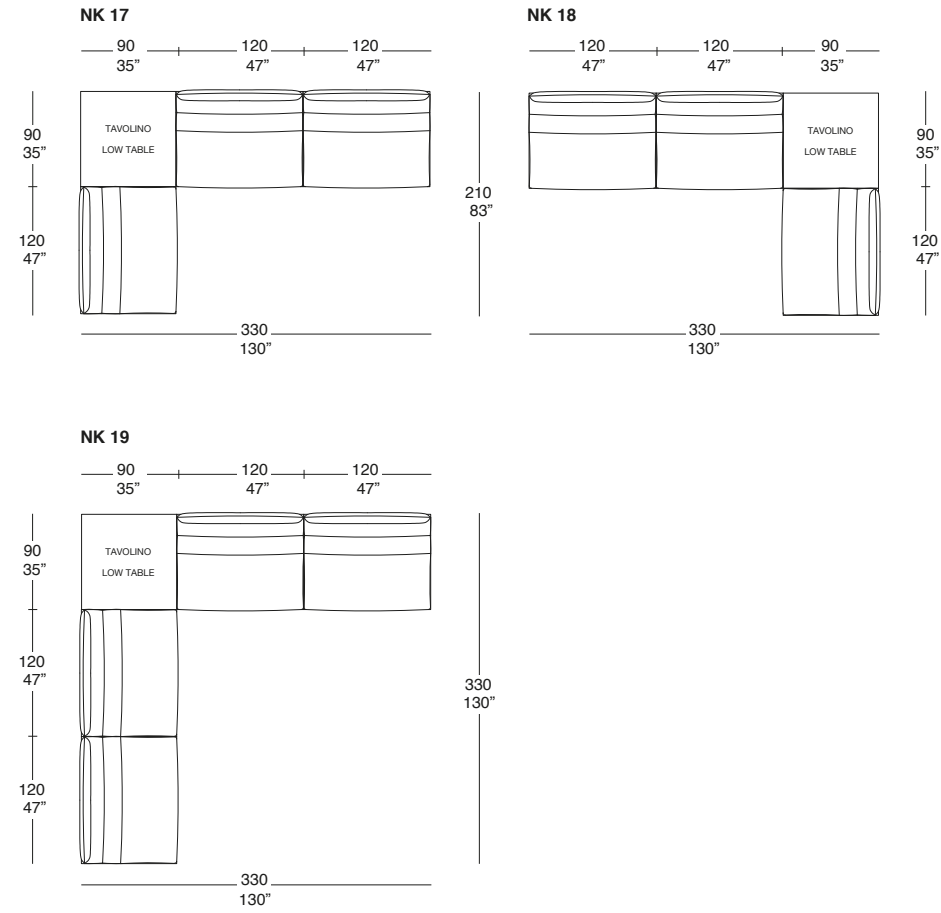

NIKOS

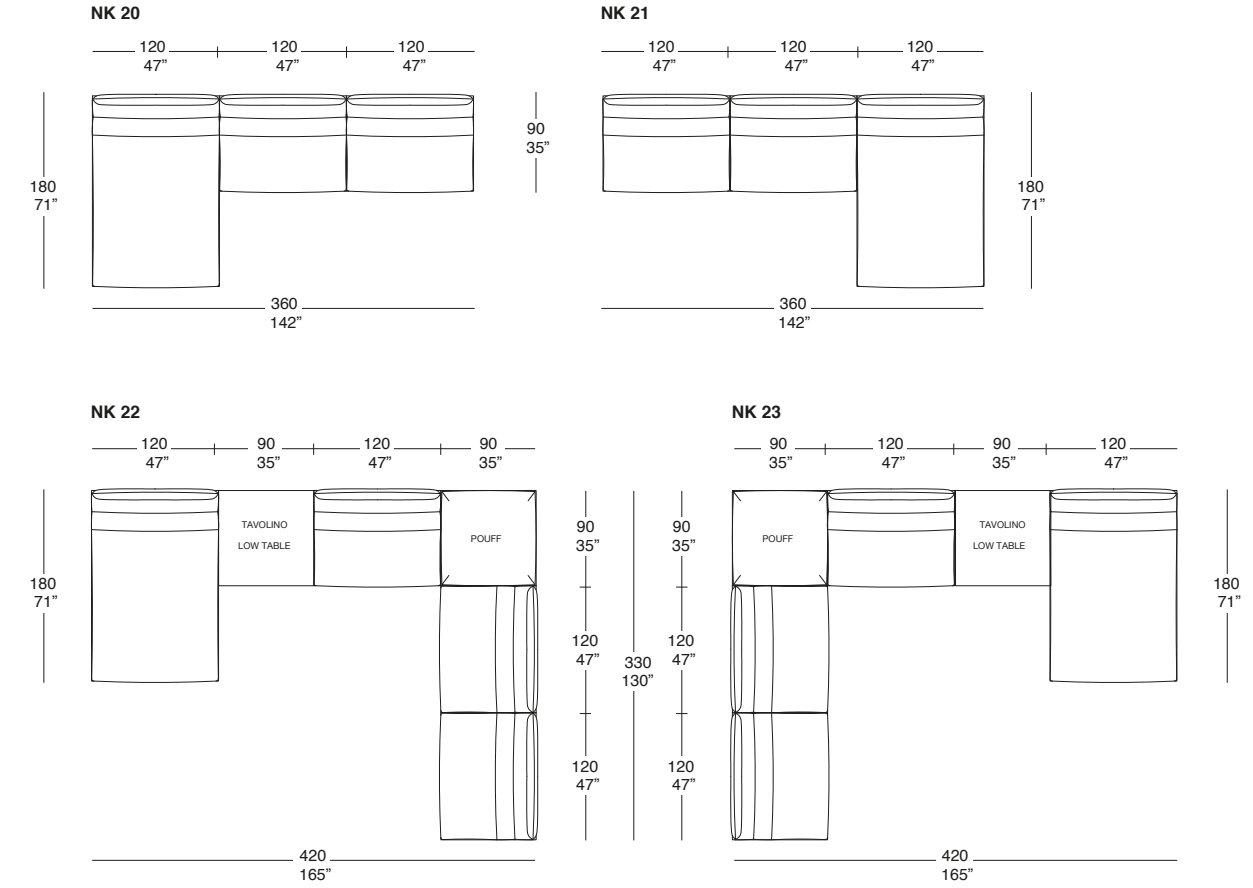

I prodotti della Collezione Outdoor sono stati testati per la collocazione da esterno, l'utilizzo ideale consigliato è per terrazzi e verande ed è buona norma proteggere gli articoli da esterno adottando accorgimenti che consentono di migliorarne la durata. È possibile acquistare l'apposito winter set che consente di proteggere meglio dalle intemperie i prodotti acquistati. Preghiamo accertarsi che tutti i prodotti siano completamente asciutti prima di coprirli per evitare accumuli di umidità o la formazione di macchie di muffa.

The products in the Outdoor Collection have been tested so that may be used outside, ideally on terraces and verandas. Outdoor furniture should receive the correct care and maintenance to extend the life of the product. Il Loft sells the special winter set which enables you to provide the best protection against bad weather for your purchases. Please ensure that all pieces of furniture are completely dry before covering them to prevent damp patches or the formation of mould stains.

NIKOS

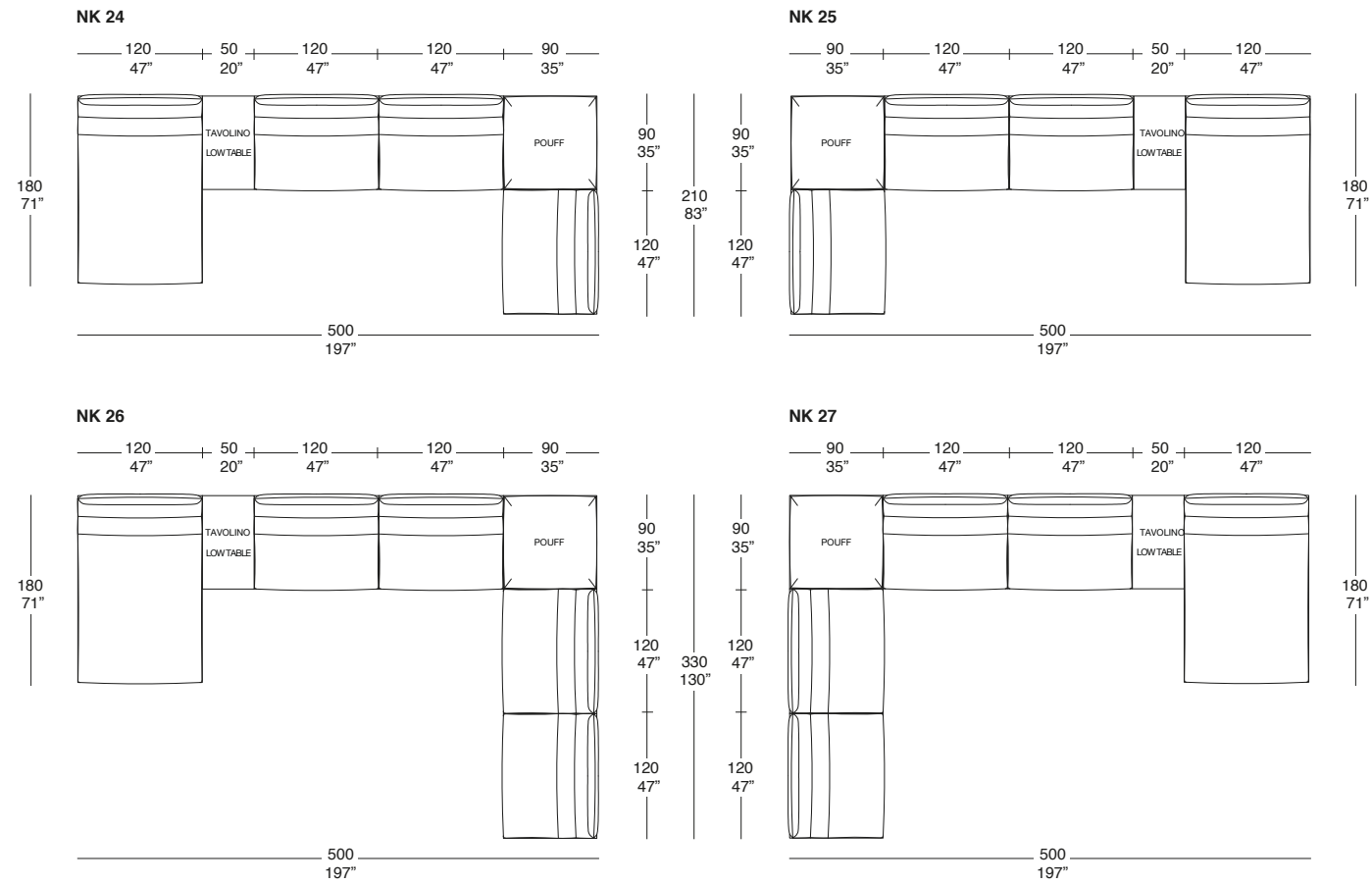

SUPER ROY

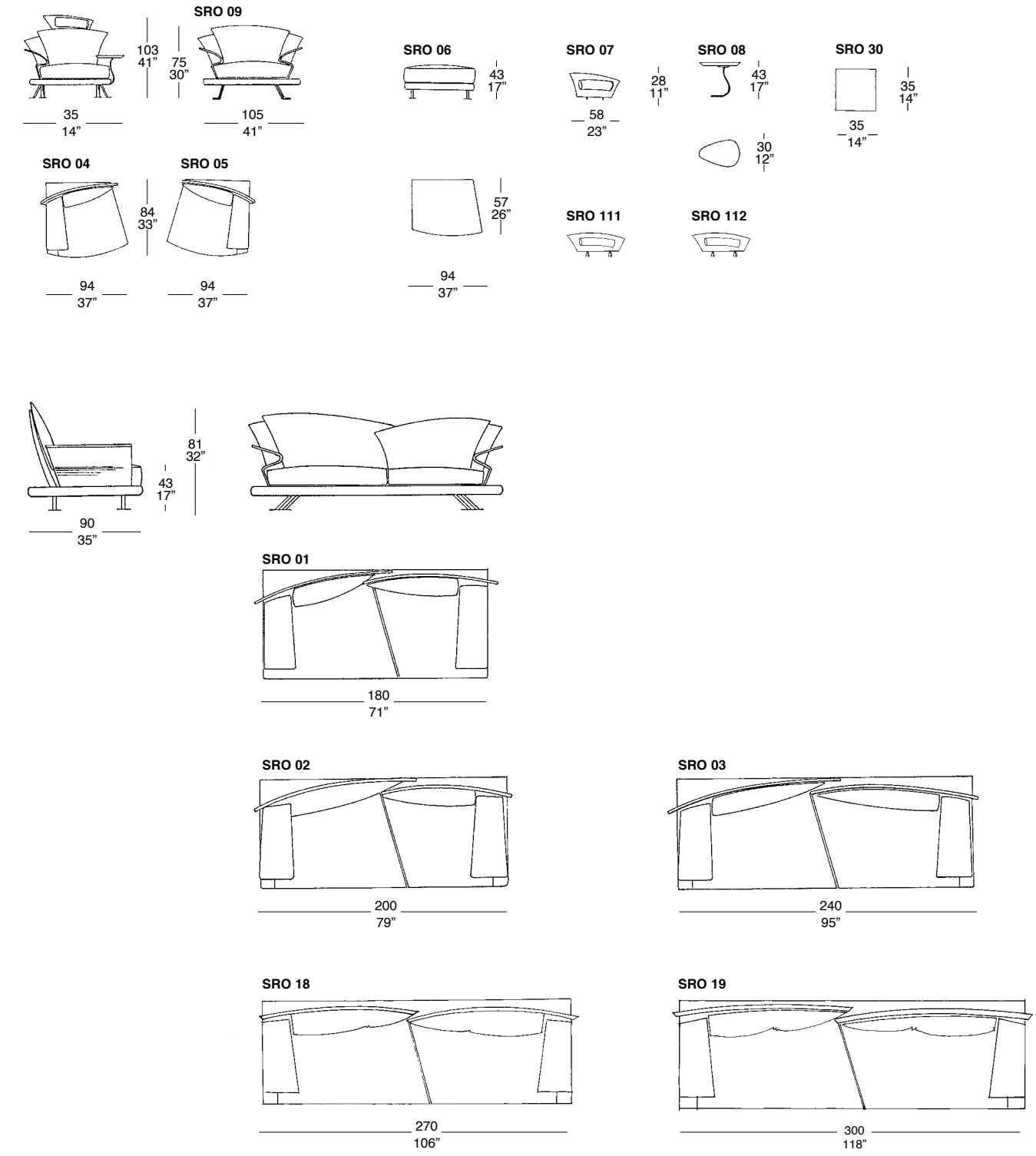

I prodotti della Collezione Outdoor sono stati testati per la collocazione da esterno, l'utilizzo ideale consigliato è per terrazzi e verande ed è buona norma proteggere gli articoli da esterno adottando accorgimenti che consentono di migliorarne la durata. È possibile acquistare l'apposito winter set che consente di proteggere meglio dalle intemperie i prodotti acquistati. Preghiamo accertarsi che tutti i prodotti siano completamente asciutti prima di coprirli per evitare accumuli di umidità o la formazione di macchie di muffa.

The products in the Outdoor Collection have been tested so that may be used outside, ideally on terraces and verandas. Outdoor furniture should receive the correct care and maintenance to extend the life of the product. Il Loft sells the special winter set which enables you to provide the best protection against bad weather for your purchases. Please ensure that all pieces of furniture are completely dry before covering them to prevent damp patches or the formation of mould stains.

SUPER ROY

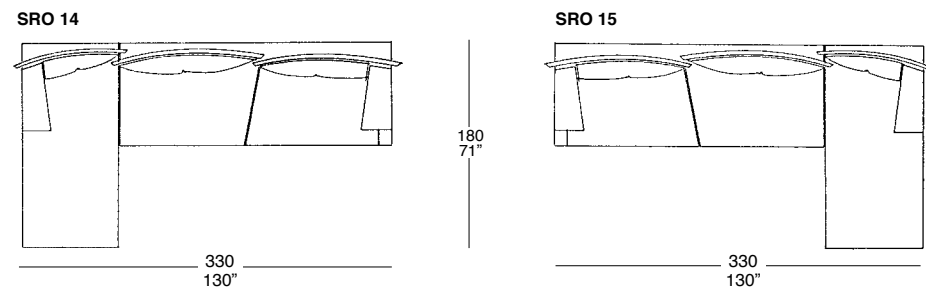
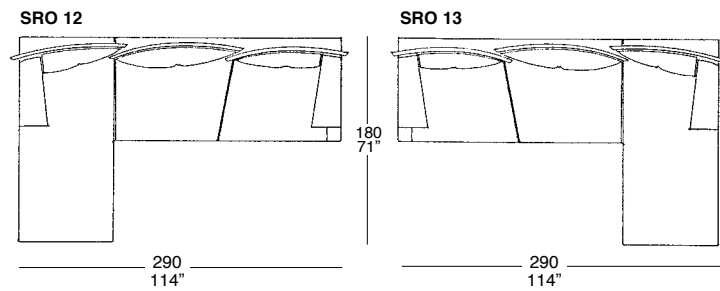
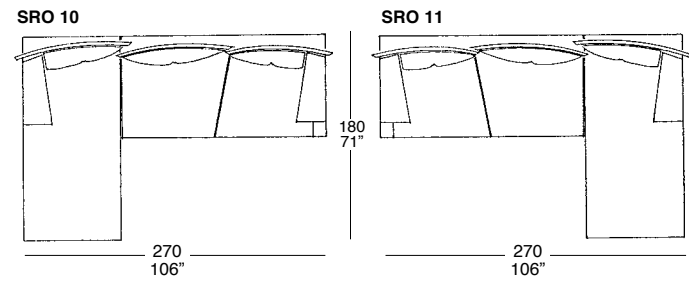
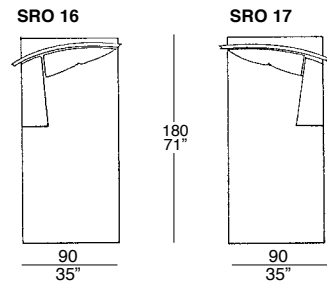

SUPER ROY

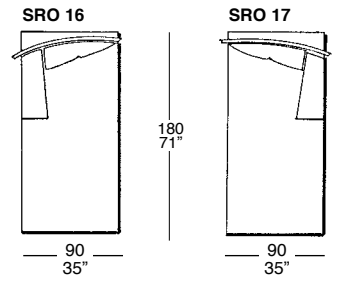
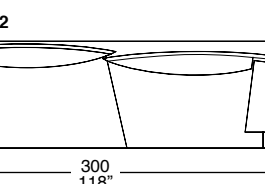
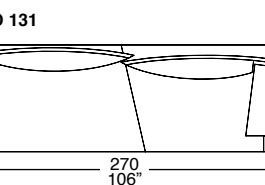
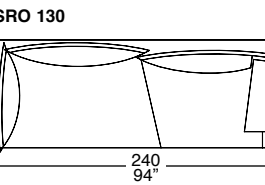
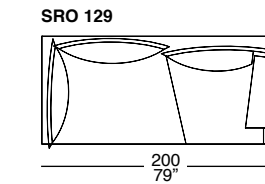
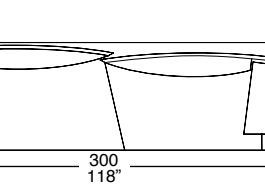
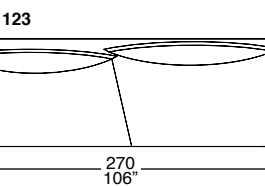
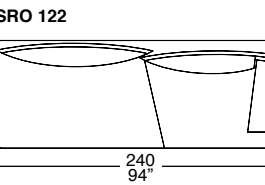
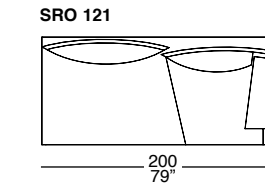
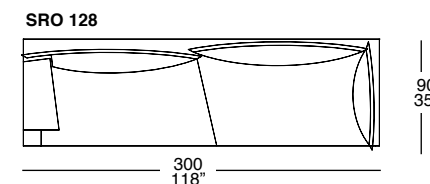
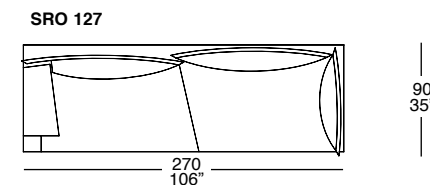
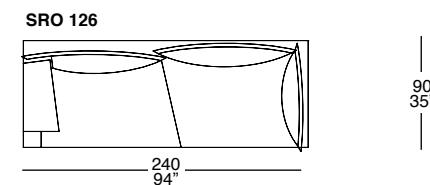
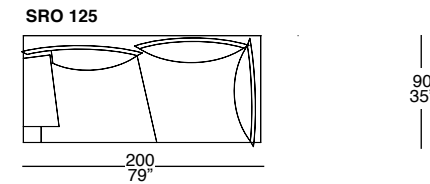
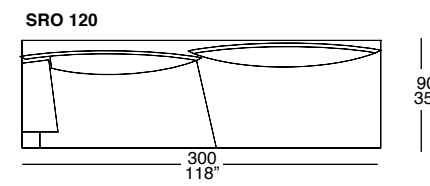
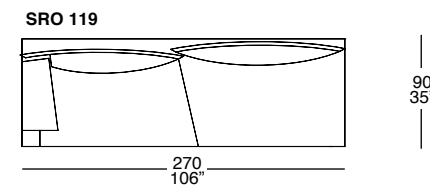
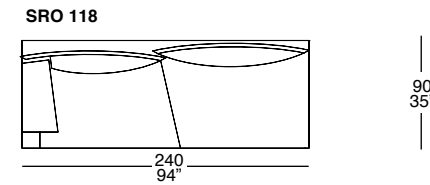
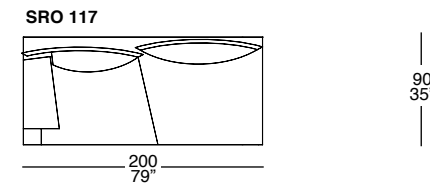

I prodotti della Collezione Outdoor sono stati testati per la collocazione da esterno, l'utilizzo ideale consigliato è per terrazzi e verande ed è buona norma proteggere gli articoli da esterno adottando accorgimenti che consentono di migliorarne la durata. È possibile acquistare l'apposito winter set che consente di proteggere meglio dalle intemperie i prodotti acquistati. Preghiamo accertarsi che tutti i prodotti siano completamente asciutti prima di coprirli per evitare accumuli di umidità o la formazione di macchie di muffa.

The products in the Outdoor Collection have been tested so that may be used outside, ideally on terraces and verandas. Outdoor furniture should receive the correct care and maintenance to extend the life of the product. Il Loft sells the special winter set which enables you to provide the best protection against bad weather for your purchases. Please ensure that all pieces of furniture are completely dry before covering them to prevent damp patches or the formation of mould stains.

SUPER ROY ANGOLARE

SRO 133

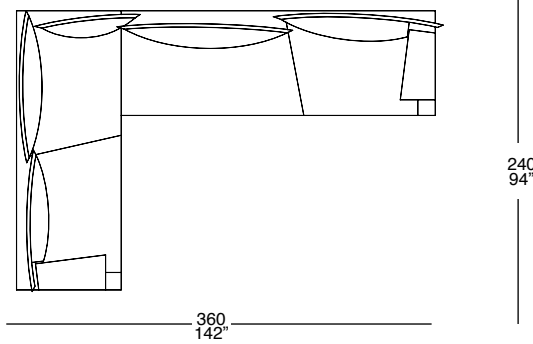

SRO 134

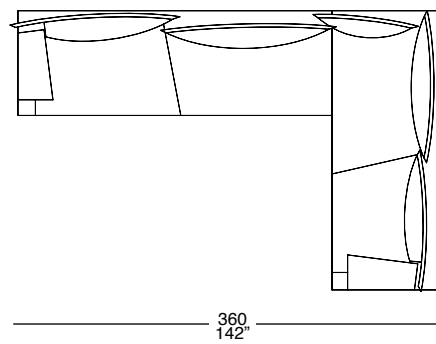

SRO 135

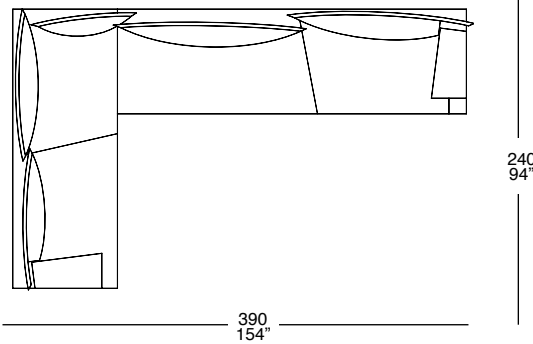

SRO 136

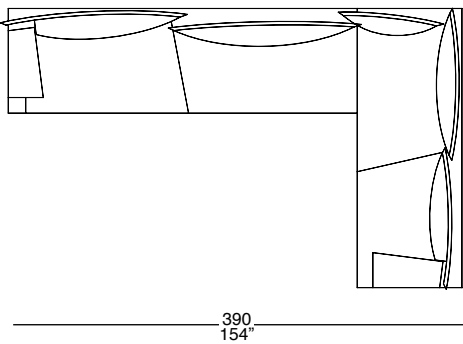

SRO 137

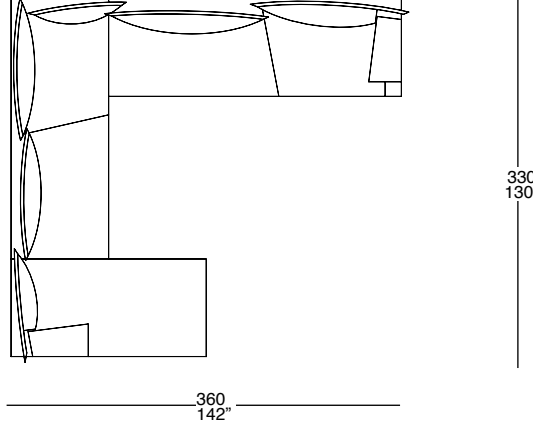

SRO 138

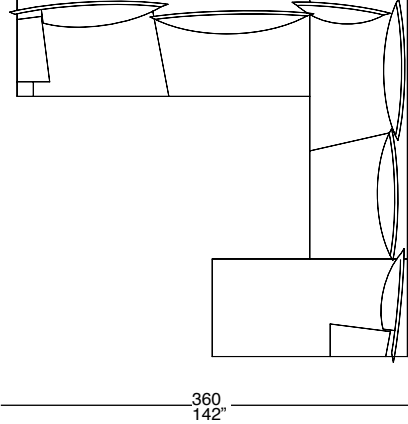

SRO 139

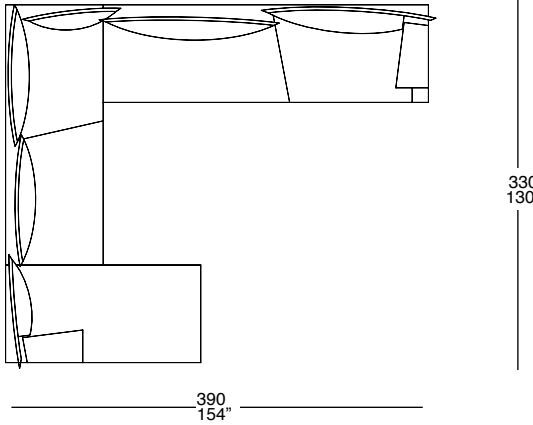

SRO 140

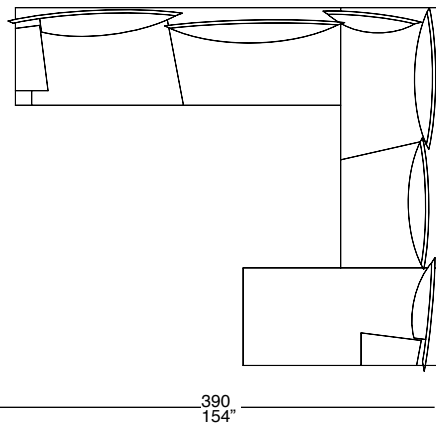

SUPER ROY ESECUZIONE SPECIALE

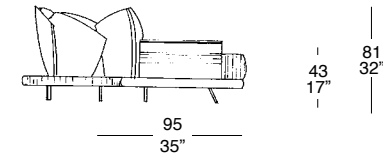

SRO 80

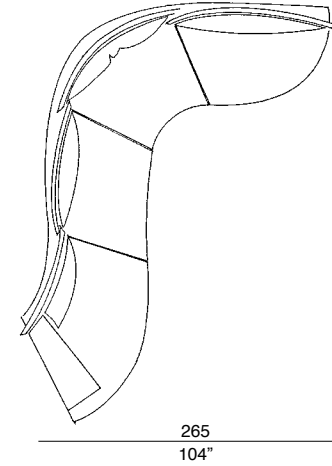

SRO 81

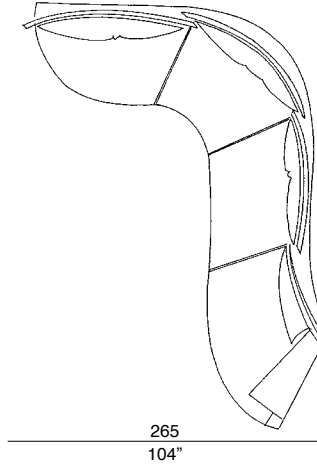

SRO 86

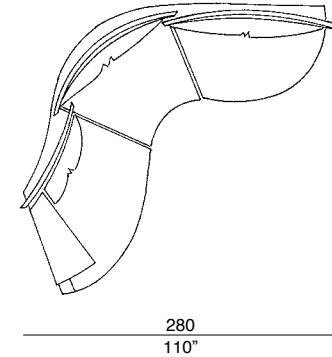

SRO 87

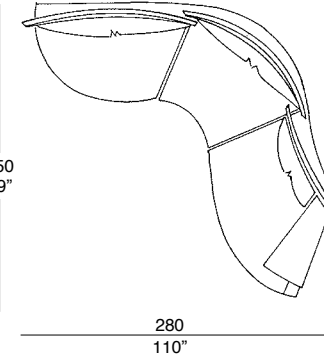

I prodotti della Collezione Outdoor sono stati testati per la collocazione da esterno, l'utilizzo ideale consigliato è per terrazzi e verande ed è buona norma proteggere gli articoli da esterno adottando accorgimenti che consentono di migliorarne la durata. È possibile acquistare l'apposito winter set che consente di proteggere meglio dalle intemperie i prodotti acquistati. Preghiamo accertarsi che tutti i prodotti siano completamente asciutti prima di coprirli per evitare accumuli di umidità o la formazione di macchie di muffa.

The products in the Outdoor Collection have been tested so that may be used outside, ideally on terraces and verandas. Outdoor furniture should receive the correct care and maintenance to extend the life of the product. Il Loft sells the special winter set which enables you to provide the best protection against bad weather for your purchases. Please ensure that all pieces of furniture are completely dry before covering them to prevent damp patches or the formation of mould stains.

SUPER ROY ESECUZIONE SPECIALE "CL"

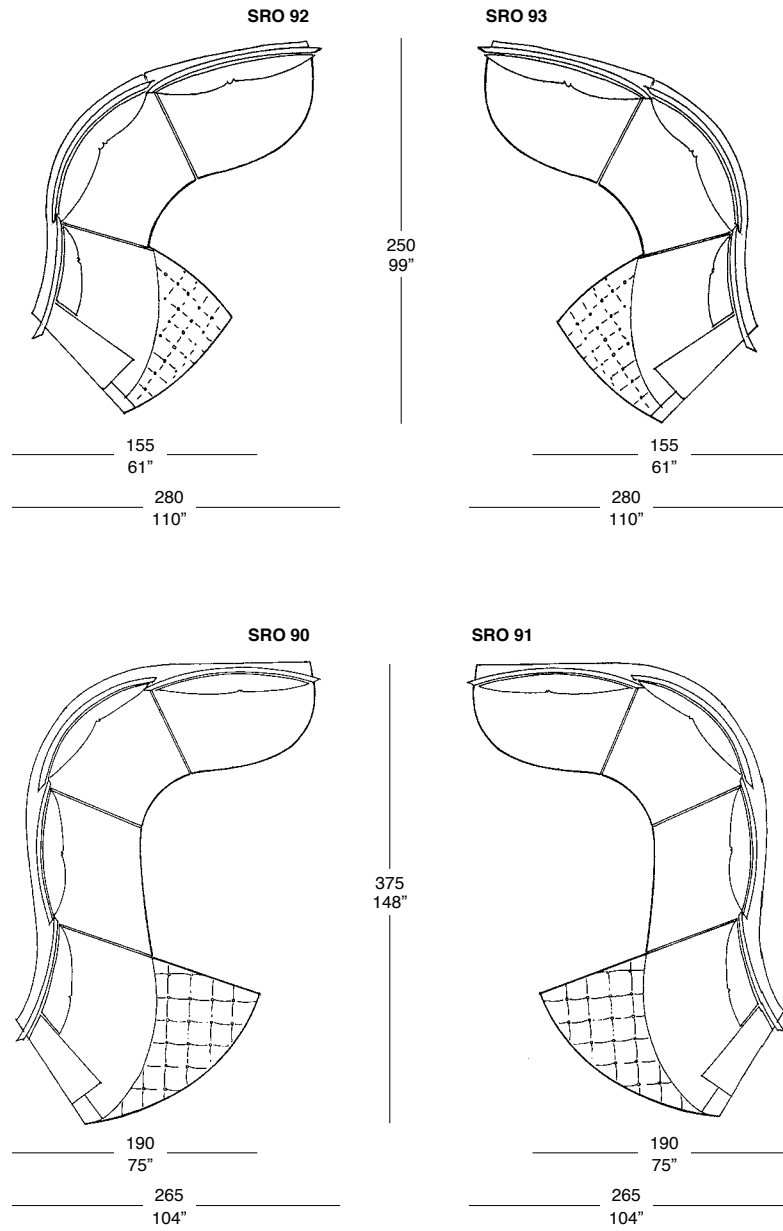

SUPER ROY ESECUZIONE SPECIALE

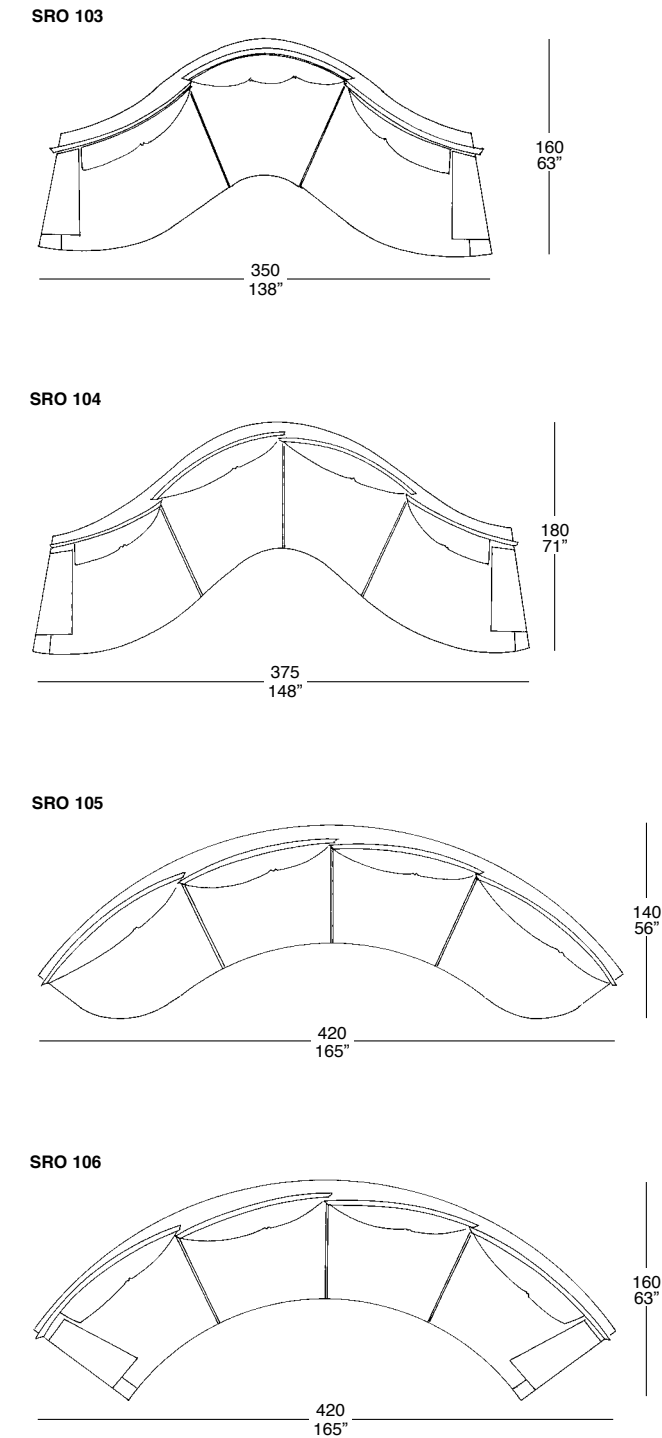

I prodotti della Collezione Outdoor sono stati testati per la collocazione da esterno, l'utilizzo ideale consigliato è per terrazzi e verande ed è buona norma proteggere gli articoli da esterno adottando accorgimenti che consentono di migliorarne la durata. È possibile acquistare l'apposito winter set che consente di proteggere meglio dalle intemperie i prodotti acquistati. Preghiamo accertarsi che tutti i prodotti siano completamente asciutti prima di coprirli per evitare accumuli di umidità o la formazione di macchie di muffa.

The products in the Outdoor Collection have been tested so that may be used outside, ideally on terraces and verandas. Outdoor furniture should receive the correct care and maintenance to extend the life of the product. Il Loft sells the special winter set which enables you to provide the best protection against bad weather for your purchases. Please ensure that all pieces of furniture are completely dry before covering them to prevent damp patches or the formation of mould stains.

POLTRONE / ARMCHAIRS

FLOWER OUTDOOR

FLO 10

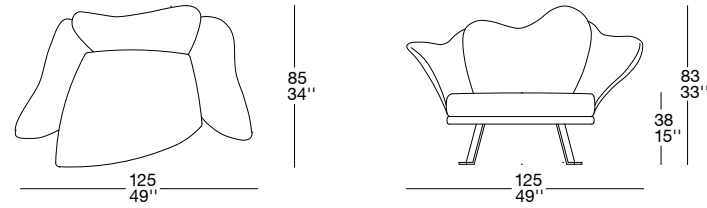

GEORGE OUTDOOR

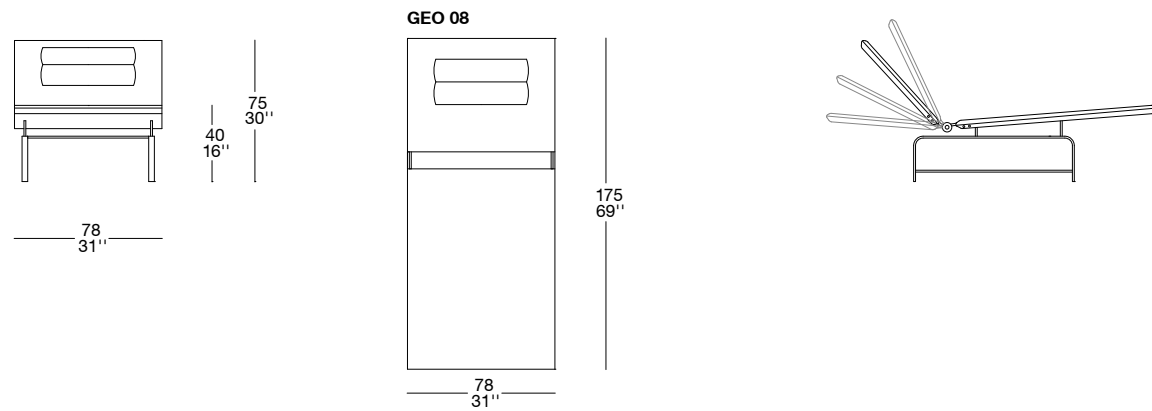

JADA OUTDOOR

JDO 01



SEDIE / CHAIRS

HERMAN OUTDOOR

HMO 07

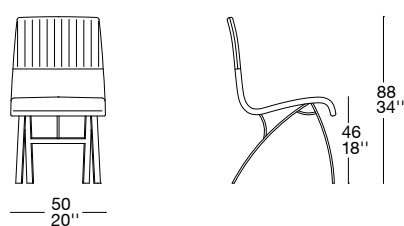

TAVOLI / TABLES

DILL OUTDOOR

DILL OUTDOOR/GRANIGLIA

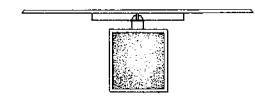

DILL OUTDOOR/ART

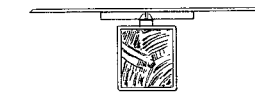

DILL OUTDOOR/GRAFFITI

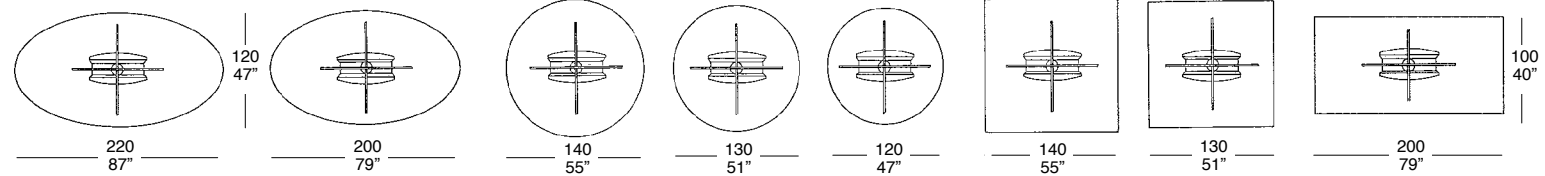
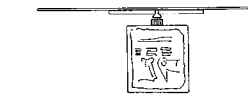

DILL OUTDOOR/GRANIGLIA

- | | | | | | | | |
|-----------------|-----------------|-----------------|-----------------|-----------------|-----------------|-----------------|-----------------|
| DLO 07 G | DLO 04 G | DLO 16 G | DLO 13 G | DLO 10 G | DLO 22 G | DLO 19 G | DLO 01 G |
|-----------------|-----------------|-----------------|-----------------|-----------------|-----------------|-----------------|-----------------|

DILL OUTDOOR/ART

- | | | | | | | | |
|-----------------|-----------------|-----------------|-----------------|-----------------|-----------------|-----------------|-----------------|
| DLO 08 A | DLO 05 A | DLO 17 A | DLO 14 A | DLO 11 A | DLO 23 A | DLO 20 A | DLO 02 A |
|-----------------|-----------------|-----------------|-----------------|-----------------|-----------------|-----------------|-----------------|

DILL OUTDOOR/GRAFFITI

- | | | | | | | | |
|---------------|---------------|---------------|---------------|---------------|---------------|---------------|---------------|
| DLO 58 | DLO 57 | DLO 61 | DLO 60 | DLO 59 | DLO 63 | DLO 62 | DLO 56 |
|---------------|---------------|---------------|---------------|---------------|---------------|---------------|---------------|

DLO 43 G

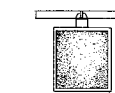

DLO 44 A

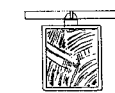

DLO 64

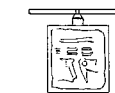

I prodotti della Collezione Outdoor sono stati testati per la collocazione da esterno, l'utilizzo ideale consigliato è per terrazzi e verande ed è buona norma proteggere gli articoli da esterno adottando accorgimenti che consentono di migliorarne la durata. È possibile acquistare l'apposito winter set che consente di proteggere meglio dalle intemperie i prodotti acquistati. Preghiamo accertarsi che tutti i prodotti siano completamente asciutti prima di coprirli per evitare accumuli di umidità o la formazione di macchie di muffa.

The products in the Outdoor Collection have been tested so that may be used outside, ideally on terraces and verandas. Outdoor furniture should receive the correct care and maintenance to extend the life of the product. Il Loft sells the special winter set which enables you to provide the best protection against bad weather for your purchases. Please ensure that all pieces of furniture are completely dry before covering them to prevent damp patches or the formation of mould stains.

TAVOLI / TABLES

SQUARE OUTDOOR

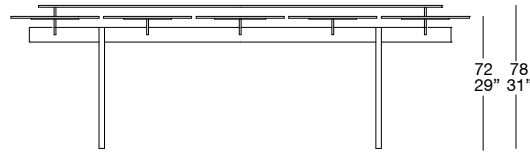

SQO 02

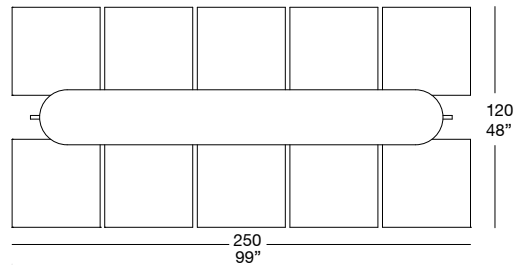

SQO 01

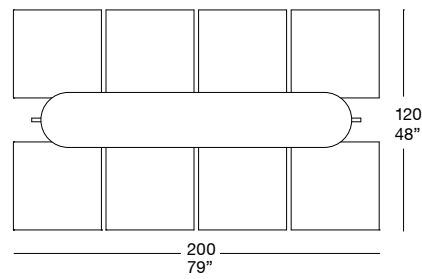

TAVOLI / TABLES

WILTON OUTDOOR

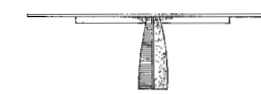
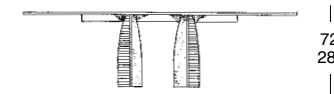

WLO 17



WLO 09

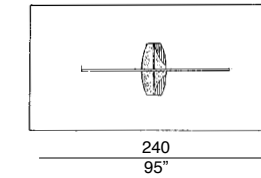

WLO 03

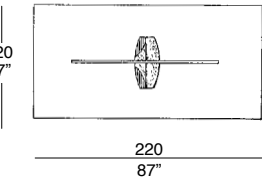

WLO 01

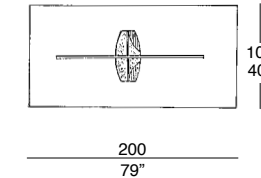

WLO 13

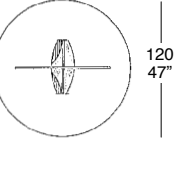

WLO 37

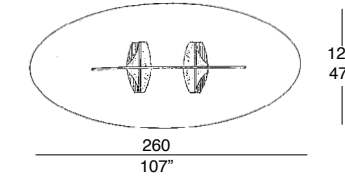

WLO 11

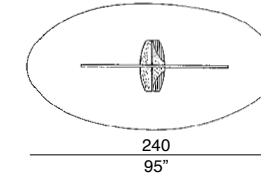

WLO 07

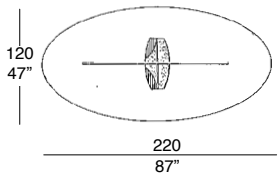

WLO 05

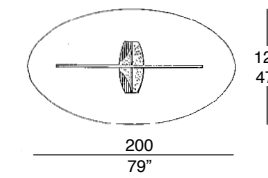

WLO 15

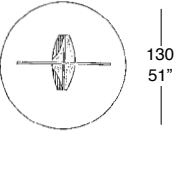

WILTON OUTDOOR / ART

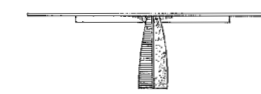
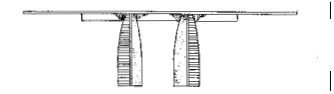

WLO 56



WLO 44

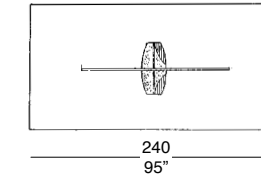

WLO 42

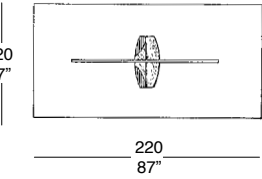

WLO 40

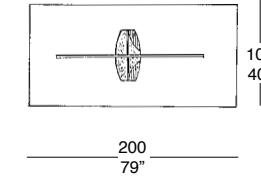

WLO 52

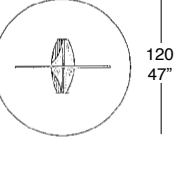

WLO 72

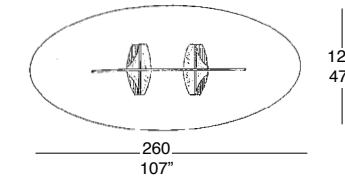

WLO 50

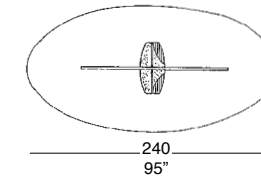

WLO 48

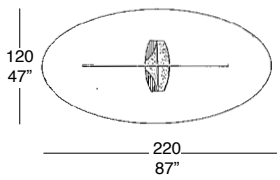

WLO 46

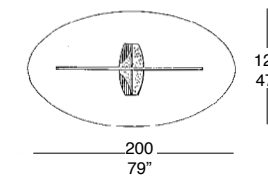

WLO 54

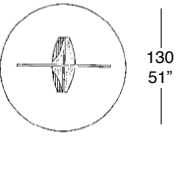

I prodotti della Collezione Outdoor sono stati testati per la collocazione da esterno, l'utilizzo ideale consigliato è per terrazzi e verande ed è buona norma proteggere gli articoli da esterno adottando accorgimenti che consentono di migliorarne la durata. È possibile acquistare l'apposito winter set che consente di proteggere meglio dalle intemperie i prodotti acquistati. Preghiamo accertarsi che tutti i prodotti siano completamente asciutti prima di coprirli per evitare accumuli di umidità o la formazione di macchie di muffa.

The products in the Outdoor Collection have been tested so that may be used outside, ideally on terraces and verandas. Outdoor furniture should receive the correct care and maintenance to extend the life of the product.

Il Loft sells the special winter set which enables you to provide the best protection against bad weather for your purchases. Please ensure that all pieces of furniture are completely dry before covering them to prevent damp patches or the formation of mould stains.

DILL OUTDOOR

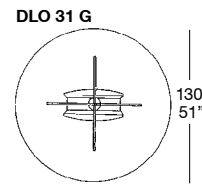
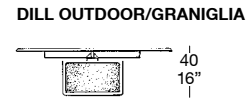

DLO 32 A

DLO 52

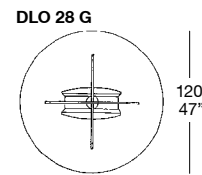

DLO 29 A

DLO 51

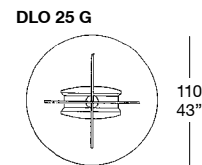

DLO 26 A

DLO 50

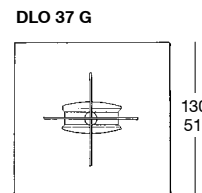

DLO 38 A

DLO 54

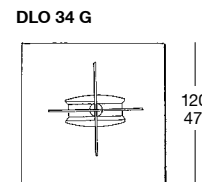

DLO 35 A

DLO 53

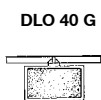

WILTON OUTDOOR



WLO 26

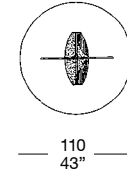

WLO 28

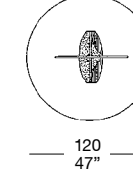

WLO 30

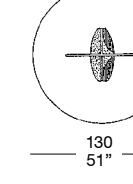

WLO 34

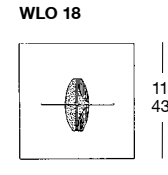
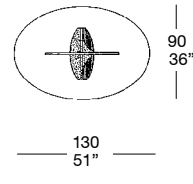

WLO 36

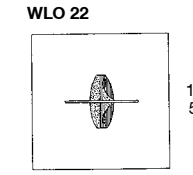
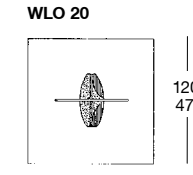

WILTON OUTDOOR / ART

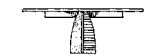

WLO 63

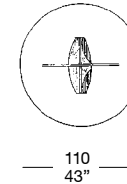

WLO 65

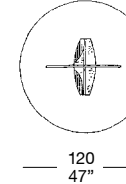

WLO 67

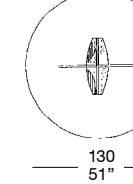

WLO 69

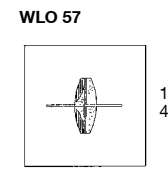
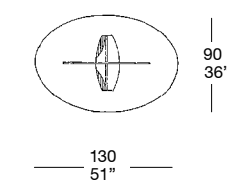

WLO 71

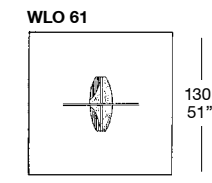
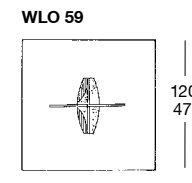
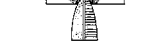

I prodotti della Collezione Outdoor sono stati testati per la collocazione da esterno, l'utilizzo ideale consigliato è per terrazzi e verande ed è buona norma proteggere gli articoli da esterno adottando accorgimenti che consentono di migliorarne la durata. È possibile acquistare l'apposito winter set che consente di proteggere meglio dalle intemperie i prodotti acquistati. Preghiamo accertarsi che tutti i prodotti siano completamente asciutti prima di coprirli per evitare accumuli di umidità o la formazione di macchie di muffa.

The products in the Outdoor Collection have been tested so that may be used outside, ideally on terraces and verandas. Outdoor furniture should receive the correct care and maintenance to extend the life of the product. Il Loft sells the special winter set which enables you to provide the best protection against bad weather for your purchases. Please ensure that all pieces of furniture are completely dry before covering them to prevent damp patches or the formation of mould stains.

Credits—

AD—
GS+KB

Graphic Design—
Byung Soo Zocchi
Blackspace

Photo—
Giorgio Saporiti jr

Printed in Italy by
AGF S.p.A.
March 2018

I colori dei tessuti, delle pelli e dei legni
delle nostre realizzazioni fotografate
su questo catalogo, possono non essere
perfettamente riprodotti in stampa—
The reproduction of the colours of our
fabrics, leather and wood photographed
in this catalogue may vary slightly from
the original shade due to printing.

EUROPE
AFRICA
RUSSIAN FEDERATION
MIDDLE EAST
FAR EAST
AUSTRALIA
AMERICA

IL LOFT S.P.A.
Via Pegoraro, 24
21013 Gallarate (Va)
Ph. +39 0331 77.65.78
Fax +39 0331 77.65.79
www.illoft.com
info@illoft.com