

ICONIC PRODUCTS AND
UNIQUE SPACES.

Rugiano

TECHNICAL DATA | INFO TECNICHE e FINITURE

Rugiano

BEDS | LETTI

BOHEME pg.16/19



Testata imbottita con cornice in metallo rivestita in pelle liscia o stampata. Dettagli in ottone lucido o bronzo. Giroletto rivestito. Completano la collezione comò, comodini, panca fronte letto, specchio da terra e una serie di sofa.

Headboard upholstered in smooth or printed leather with a metal frame finished in bronze or gloss brass. Upholstered bed-frame.

The Bohème range includes bed, bedside tables, chest of drawers, bench, mirror and sofa.

in the picture/in foto: NU198 + NT16

2077/160 cm215x217xH171

2077/180 cm215x217xH171

2077/200 cm235x217xH171

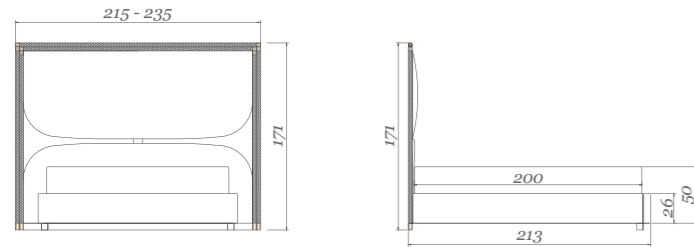

CLUB pg.22/25



Testata imbottita caratterizzata dalla trafile in ottone spazzolato o bronzo che intercalata alla pelle crea una piacevole modularità.

Upholstered headboard characterised by brushed brass or bronze finishing metal details which, combined with the leather, creates a stylish pattern.

in the picture/in foto: NP06

2078/160 cm232x222,5xH130

2078/180 cm232x222,5xH130

2078/200 cm232x222,5xH130

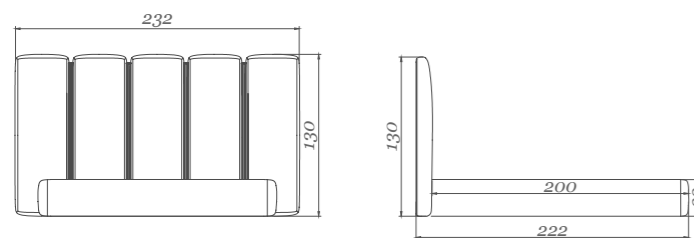

GRACE pg.6/7



Testata imbottita con cornice in metallo rivestita in pelle liscia o stampata. Dettagli in bronzo. Giroletto rivestito.

Completano la collezione comò e comodini.

Headboard upholstered in smooth or printed leather with a metal details finishing in bronze. Upholstered bed-frame.

The Grace range includes bed, bedside tables and chest of drawers.

in the picture/in foto: NU179 + NT15

2075/160 cm225x217xH177

2075/180 cm225x217xH177

2075/200 cm245x217xH177

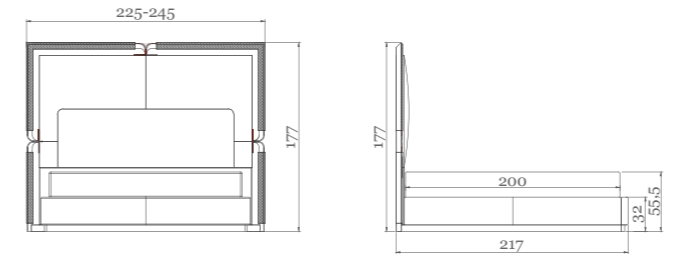

GRACE BIG pg.12/15



in the picture/in foto: 1050/090 + NT14

2074/180 cm342x217xH145

2074/200 cm342x217xH145

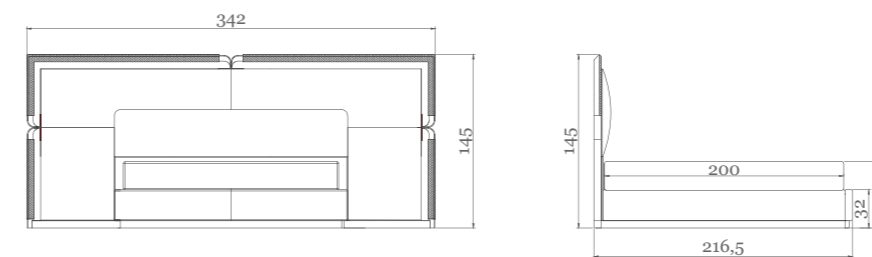

KENYA pg.34/35



Testata lineare con cornice rivestita in pelle stampato o liscia, riempita con un'imbottitura rivestita in pelle lavorata capitonné, che insieme al semplice giroletto dona immediatamente eleganza e ricercatezza.
Characterised by the Capitonné upholstery on the headboard, whose frame can be either upholstered or finished in Makassar Ebony, and an essential upholstered bed-frame, it denotes elegance and refinement.

in the picture/in foto: TNL35 + PT17

2065/160 cm214x217xH144

2065/180 cm234x217xH144

2065/200 cm254x217xH144

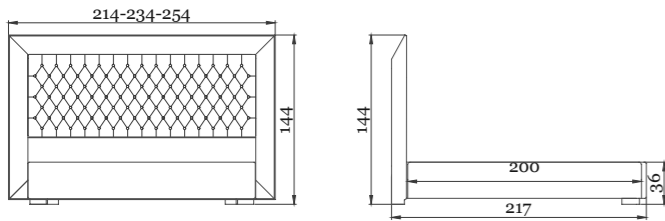

VOGUE pg.28/29



Testata imbottita rivestita completamente con dettaglio centrale in bronzo o acciaio. Giroletto rivestito.
La testata è disponibile completamente liscia o con ricamo baguette.
Completano la collezione comò, comodini, e settimano.
*Upholstered headboard with "baguette" stitching or plain leather with central metal detail in bronze or steel. Upholstered bed-frame.
The Vogue range includes bed, bedside tables, chest of drawers, tallboy and sofa*

in the picture/in foto: NU234

2070/160 cm232x222,5xH130

2070/180 cm232x222,5xH130

2070/200 cm232x222,5xH130

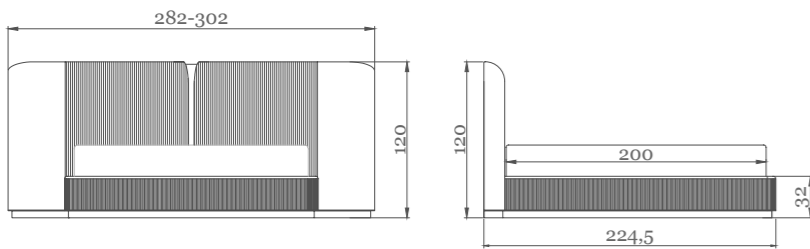

BEDSIDE TABLES | COMODINI

BOHEME pg.16/17 - 20

Comodino a 2 cassetti rivestito in pelle con piano in marmo e dettagli in ottone lucido.
Bedside table with 2 drawers, upholstered in leather, with marble top and gloss brass details



3091/MB cm64x44xH53

CLUB pg.24

Comodino a 1 cassetto rivestito in pelle con piano in marmo e dettagli in ottone spazzolato o bronzo.
Bedside table with 1 drawer, upholstered in leather, with marble top and metal details finished either in bronze or brushed brass



3093/MB cm55x42xH52

GRACE pg.7/8

Comodino a 1 cassetto rivestito in pelle con dettagli in bronzo.
Bedside table with 1 drawer, upholstered in leather, with bronze details



3074/1C cm55x45xH54

VOGUE pg.28/29

Comodino a 1 cassetto rivestito in pelle con piano in marmo.
Bedside table with 1 drawer, upholstered in leather, with marble top



3070/1CB cm Ø50xH50

3070/1CL cm Ø50xH50

CHEST OF DRAWERS | COMO'

BOHEME pg.21



Comò a 3 cassetti rivestito in pelle con piano in marmo e dettagli in ottone lucido.
Chest of drawers with 3 drawers, upholstered in leather, with marble top and gloss brass details

3092/140MB cm140x56xH74

CLUB pg.26/27



Comò a 3 cassetti rivestito in pelle con piano in marmo e dettagli in ottone spazzalato o bronzo.
Chest of drawers with 3 drawers, upholstered in leather, with marble top and metal details finished either in bronze or brushed brass

3094/PB cm140x50xH81

GRACE pg.9



Comò a 3 cassetti rivestito in pelle con dettagli in bronzo.
Chest of drawers with 3 drawers, upholstered in leather, with bronze details

3075/3C cm140x50xH83

VOGUE pg.32/33



Comò a 3 cassetti rivestito in pelle con dettagli in bronzo, piano in marmo.
Chest of drawers with 3 drawers, upholstered in leather, with marble top and bronze details

3071/3CB cm157x50xH85
3071/3CL cm157x50xH85

BENCHES | PANCHE

ARTHUR pg.10/11



Panca con struttura in bronzo e dettagli in pelle stampata o liscia.
Upholstered bench with bronze structure with inlaid leather detail

3073/152 cm152x50xH43

BOHEME pg.16/17



Panca imbottita con base in metallo rivestita in pelle liscia o stampata
Upholstered bench with metal base

3075/143 cm161x51xH40

FORM ZIP pg.22/23 - 25



Panca/pouf imbottita con dettaglio zip sulla seduta che può essere personalizzata con ricamo.
Upholstered bench / pouf with zip detail. Available with stitching

6024 cm120x45xH40
6024/14 cm140x45xH40
6024/18 cm180x80xH40

DESKS | SCRIVANIE

ROMA pg.36/37



Scrivania con base in bronzo e piano rivestito ed attrezzato con vani porta oggetti e un cassetto.
Desk with bronze finished structure and upholstered top with small compartments and a drawer.

6062/130 cm130x63xH85

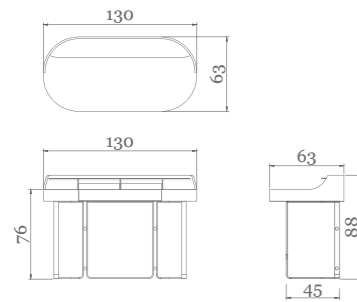

DINING TABLES | TAVOLI

ABSOLUTE pg.40/43



Tavolo con base scultura creata dalla contrapposizione di due materiali bronzo ed oro lucido, oppure cromo nero e acciaio. Piani disponibili in diverse forme e misure in legno, marmo o decorati.
Dining Table with sculptural base characterised by the contrast between similar finishes, either bronze and gloss gold or black chrome and chromed steel. The top is available in a variety of dimensions and can be decorated or made out of wood or marble

in the picture/in foto:
bronzo verniciato + oro lucido/ varnished bronze + glossy gold
ebano satinato/satin ebony

4052/260 cm260x130xH75

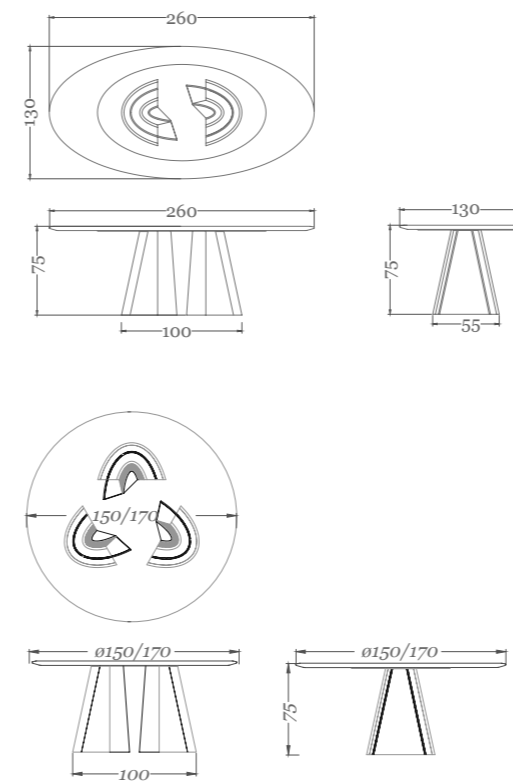

ALYSON pg.44/45



Una serie di tubolari in oro chiaro o cromo nero accostati e curvati elegantemente creano la base del tavolo. Piani disponibili in diverse forme e misure in legno, marmo, vetro, rivestiti in pelle o decorati.
A series of gloss gold or black chrome tubes, skilfully curved and welded, create the base. The top is available in a variety of dimensions and can be made out of wood, marble, glass or upholstered in leather

in the picture/in foto: oro chiaro/light gold + ebano/ebony

4017/240 cm240x120xH75

4017/300 cm300x120xH75

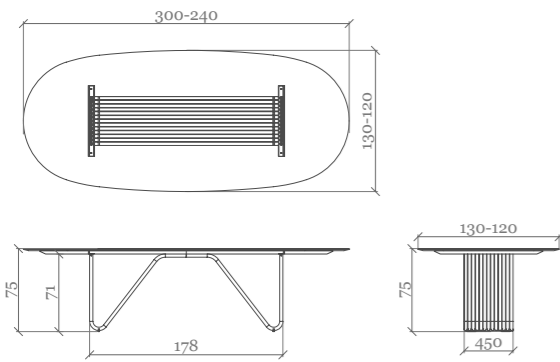

pg.44/45



in the picture/in foto: oro chiaro/light gold + vetro/glass

4017/250 cm250x120xH75

4017/310 cm310x120xH75

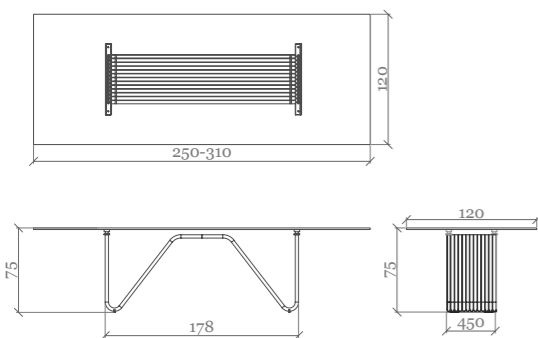

ALYSON ROUND pg.49 - 51 - -52/53 - 96/97



in the picture/in foto:
oro chiaro/light gold + verde guatemala/guatemala green

4017/150 cm ø150xH75

4017/170 cm ø170xH75

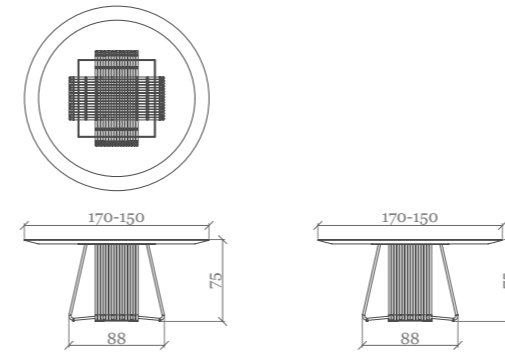

FOREST pg.60/61

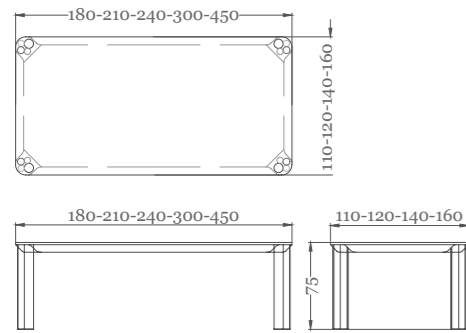

Oro lucido o cromo nero caratterizzato le gambe importanti. Piani disponibili in diverse forme e misure in legno, marmo, rivestiti in pelle o decorati.

Gloss gold or black chromed legs composed by skilfully welded tubes. The top is available in a variety of dimensions and can be decorated, made out of wood or marble or upholstered in leather.

in the picture/in foto: oro lucido/glossy gold + ebano/ebony

4045/140 cm140x140xH75
4045/180 cm180x140xH75
4045/210 cm210x110xH75
4045/240 cm240x120xH75
4045/240B cm240x160xH75
4045/300 cm300x120xH75

FOREST ROUND pg.62/63

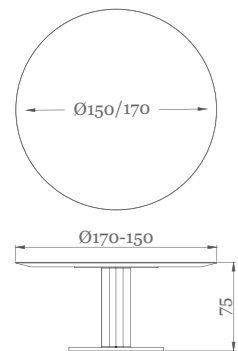

in the picture/in foto: bronzo/bronze + decoro

4045/150 cm ø150xH75
4045/170 cm ø170xH75

LIBERTY pg.66/67

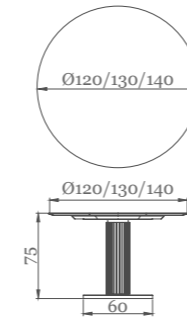

Collezione di tavoli caratterizzati dalla base a colonna, un estruso in alluminio con finitura bronzo. Piano tondo per la monobase, mentre la base a tre colonne ha il piano ovale.

I piani sono disponibili in marmo o decorati. Dining table characterised by the column-like base, an aluminium extrusion finished in bronze. Single column base comes with a round top, whereas the three column base comes with an oval top. The top is available in marble or hand-painted finishes

in the picture/in foto: bronzo/bronze + rosso lepanto/red lepanto

9015/B120 cmØ120xH75
9015/B130 cmØ130xH75
9015/B140 cmØ140xH75

LIBERTY 3 pg.68/69



in the picture/in foto: bronzo/bronze + patagonia

9015/B170 cm170x140xH74

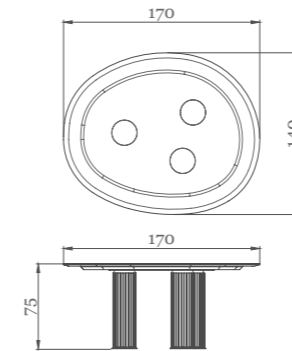

PLIET pg.64/65



Base in bronzo caratterizzata dall'elegante torsione sulle gambe.
 Piani disponibili in diverse forme e misure in legno, rivestiti in pelle o decorati.
*Bronze base featuring a distinctive twist detail in the legs.
 The top is available in a variety of dimensions and can be decorated, made out of wood or upholstered in leather.*
 in the picture/in foto: bronzo/bronze + ebano/ebony

- 4000/O240** cm240x120xH75
- 4000/O300** cm300x130xH75
- 4000/R210** cm210x110xH75
- 4000/R240** cm240x120xH75
- 4000/85** cm ø85xH75
- 4000/150** cm ø150xH75

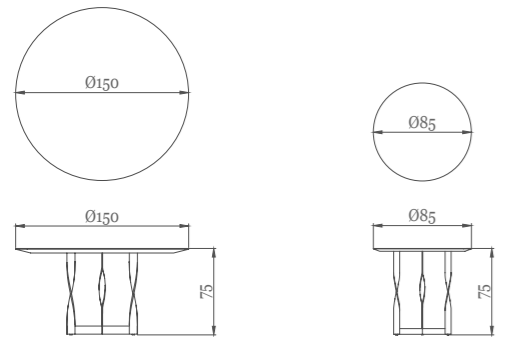
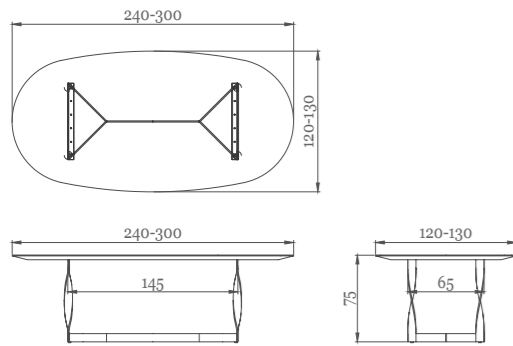
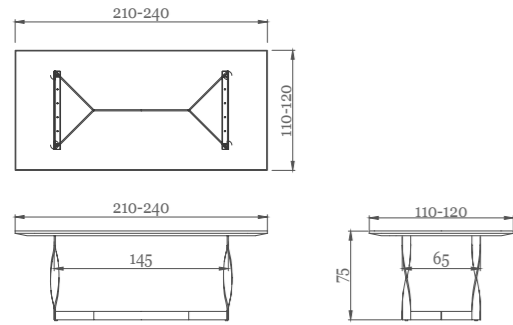

PEDRO pg.54/59



Basi scultura in bronzo.
 Piano ovale disponibile in diverse misure in legno, marmo o decorati.
*Sculpturesque bronze base.
 The top is available in marble, wood or hand-painted finishes*

in the picture/in foto: bronzo/bronze + decoro

- 4051/240** cm240x120xH75
- 4051/300** cm300x130xH75

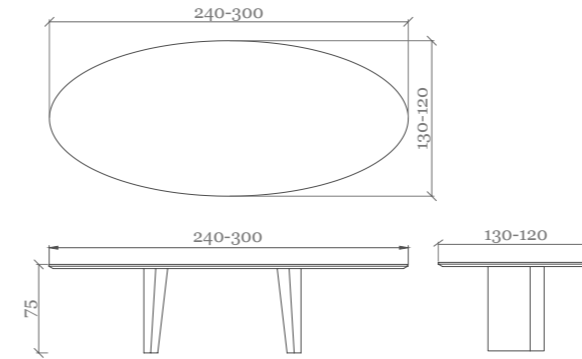

ZOE pg.86/87



Tavolo elegante e scultoreo, base in fusione di bronzo.
 Piani tondi disponibili in legno, rivestiti in pelle, decorati e marmo.
*Elegant and sculpturesque dining table, base in bronze fusion
 Top available in natural wood, with hand-painted finishes, upholstered in leather or marble*

in the picture/in foto: bronzo/bronze + ebano/ebony

- 4031/150** cmØ150xH75
- 4031/170** cmØ170xH75

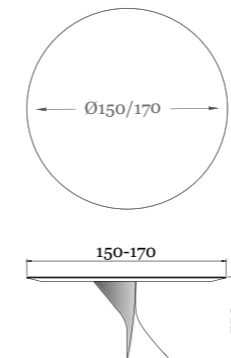

CHAIRS | SEDIE

AIDA pg.80/81



Sedia e capotavola completamente rivestite o con gambe in legno. Retro liscio o caratterizzato da ricamo ELLE.
Chair, also available with high back, wholly upholstered or with wooden legs. Outer backrest plain or with ELLE stitching

5050/S cm67,5x60xH82,5
5050/B cm80x80xH105,4

MANTA pg.76/79



Poltroncina completamente rivestita. Completa la collezione di imbottiti tutti caratterizzati da questo schienale importante. In aggiunta anche l'elegante sgabello regolabile.
Wholly upholstered small armchair. Together with the bar stool, enriches and completes the MANTA range

5055 cm67x65xH85
5056 cm64x52xH99

ARIA pg.82/83



Sedia completamente rivestita. Disponibile anche la versione con seduta ricamata o con retro e scocca rivestite in pelle stampata.
Wholly upholstered chair. Also available with stitched seating or with structure upholstered in printed leather

5044 cm50x62,5xH89

MARIE pg.74/75



Poltroncina rivestita con base in bronzo.
Upholstered chair with bronze base

5052 cm67,5x60xH82,5

EGG pg.84/85



Poltroncina completamente rivestita o con gambe in cromo nero o oro chiaro.
Wholly upholstered small armchair with black chrome or gloss brass legs

5056/CNR cm58x58xH81
5056/ONR cm58x58xH81
5056/RR cm58x58xH81

POCKET - POCKET P pg.70/73



Sedia e capotavola rivestita con gambe in legno. Retro liscio o caratterizzato da ricamo ELLE.
Upholstered chair, also available with high back, with wooden legs. Outer backrest plain or with ELLE stitching

5057 cm52,5x56xH83
5058 cm52,5x54xH83

SIDEBOARD | CREDENZE

BLADE pg.88/89 - 92/95



Collezione di mobili contenitori. Base in bronzo, acciaio o cromo nero. Strutture in ebano o rivestite in pelle ed ante in ebano, rivestite in pelle o decoro per la versione alta della credenza.
Sideboard range. Base in bronze, chrome or black chrome. Structures in Ebony or upholstered in leather. Doors in ebony, or upholstered in leather, or hand-painted

6020/210 cm210x50xH80
6020/250 cm250x50xH80



6020/120 cm120x50xH200

CALLAS pg.104/107



Collezione di mobili contenitori. Strutture in acciaio o rivestite in pelle ed ante rivestite in pelle con ricamo “onda” e particolare dettaglio che crea impugnatura per permettere l’apertura delle ante.
Sideboard Range. Structure in chrome or upholstered in leather. Upholstered doors available with or without ONDA stitching, with corner handle detail for door-opening

W25/210 cm210x50xH94,5



W25/105 cm105x50xH115

IOLANDA pg.97/99



Credenza con dettagli in bronzo. Struttura rivestita in pelle ed ante in pelle ricamate. Piano in marmo e schienale in vetro retroilluminato.
Sideboard with bronze details. Structure upholstered in leather and doors with stitching. Top in marble with back lighting.

6010/220 cm220,5x50xH113

IOLE pg.102-103



Vetrina con dettagli in bronzo. Struttura rivestita in pelle ed ante in vetro. Comodo cassetto interno con frontale ricamato, piano in marmo e schienale in vetro retroilluminato.
Sideboard with bronze details. Structure upholstered in leather and glass doors. Internal drawer with stitching door, top in marble with back lighting.

6010/L cm115,5x50xH150,5

BOOKCASE | LIBRERIE

FRAME pg.108/111



Librerie con montanti in bronzo verniciato o cromo nero, disponibili con quantità diverse di ripiani, rivestiti in pelle o in marmo e con l'aggiunta di box contenitori anch'essi rivestiti in pelle con ante ricamate e con la possibilità di aver l'apertura dei box da ambo i lati nelle soluzioni dove la libreria è pensata a entro stanza.
Bookshelves with bronze or dark chrome varnished structure, available in different configurations. Shelves available in leather or marble. Box upholstered in leather and available with or without stitching and with front only or back and front opening.

6030/260 cm120x35xH257/300
6030/350 cm120x35xH297/350
6030/400 cm120x35xH347/400

6030/260BA - 6030/260BB cm120x40xH257/300
6030/350BA - 6030/350BB cm120x40xH297/350
6030/400BA - 6030/400BB cm120x40xH347/400

FRAME A pg.112/113



Librerie autoportanti con struttura in bronzo verniciato o cromo nero, disponibili con quantità diverse di ripiani, rivestiti in pelle o in marmo e con l'aggiunta di box contenitori anch'essi rivestiti in pelle con ante ricamate e con la possibilità di aver l'apertura dei box da ambo i lati nelle soluzioni dove la libreria è pensata a entro stanza.
Self-standing bookshelves with bronze or dark chrome varnished structure, available in different configurations. Shelves available in leather or marble. Box upholstered in leather and available with or without stitching and with front only or back and front opening.

6030/170 cm120x35xH170
6030/170B cm120x45xH170

ASIA pg.114/115



Librerie con montanti disponibili in due diverse combinazioni, bronzo e acciaio o rivestiti in pelle. Ripiani rivestiti in pelle.
Bookshelves with structure in two different combination, bronze and chrome or upholstered. Shelves upholstered.

6031/240 cm240x43xH176

PLASMA HOLDER | PORTA TV

BLADE pg.90/91



Mobile porta TV. Base in bronzo, acciaio o cromo nero. Strutture in ebano o rivestite in pelle ed ante in ebano, rivestite in pelle o decoro per la versione alta della credenza.
TV cabinet. Base finishes in bronze, chrome or black chrome. Structure in ebony or upholstered in leather; Doors in ebony, or upholstered in leather, or hand-painted

in the picture/in foto: bronzo/bronze + ebano/ebony

6021/210 cm210x50xH60
6021/250 cm250x50xH60

IOLANDA LOW pg.100/101



Mobile porta TV con dettagli in bronzo. Struttura rivestita in pelle ed ante in pelle ricamate.
TV Cabinet with bronze details. Structure upholstered in leather; doors with stitching.

in the picture/in foto: GAL 13 + NU 179

6014/220 cm220x50xH59

GHOST pg.100/101



Mobili porta tv a parete. Dettagli, acciaio o bronzo. Cornice rivestita in pelle con ricamo.
Media Mirror: Detail in bronze or chrome. Upholstered frame with stitching.

in the picture/in foto: NU 179

W109/134 cm134,2x13xH134,2
W109/180 cm180x13xH180
W109/212 cm212x13xH180
W109/235 cm134,2x13xH235

SOFAS | DIVANI

ARTHUR

Collezione di imbottiti componibile con dettaglio particolare della struttura del bracciolo. Struttura disponibile in bronzo e cromo nero e rivestita in pelle.
Range of modular upholstered furniture with inlaid leather detailing on the armrests. Structure available in bronze or black chrome



Elemento con un bracciolo
Unit with 1 armrest

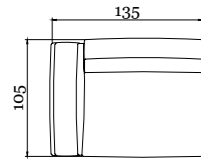

Elemento centrale
Central unit

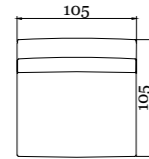

Chaise longue con 1 bracciolo
Chaise longue with 1 armrest

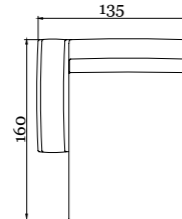

Pouf

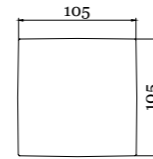

pg.174/177

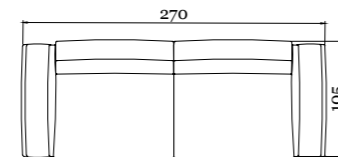

in the picture/in foto: 08 OASI + NT15 + bronzo/bronze
6095/266 cm270x105xH82

BOHEME

Collezione di imbottiti con base in metallo rivestita in pelle liscia o stampata. Dettagli in ottone lucido o bronzo.
Range of seating elements with base made of metal and upholstered in leather. Details in gloss gold or bronze



Divani
Sofas

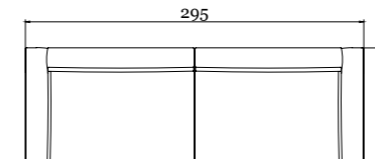
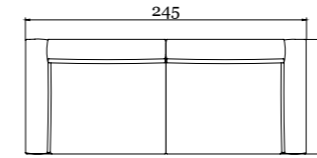
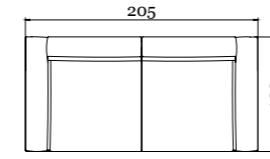

pg.150/155

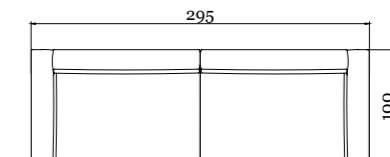

in the picture/in foto: 20 TORTORA + NT15 + ottone lucido/glossy brass
6205/295 cm295x100xH67,5

BRAID



Collezione di imbottiti con scocca intrecciata rivestita in cuoio o pelle. Un cesto contenitore che racchiude tutte le lavorazioni artigianali ed accoglie sedute e schienali.
A range of seating elements characterised by an upholstered braided structure.
A "nest" that displays our craftsmanship skills and features an extremely comfortable seating.

Divani
Sofas

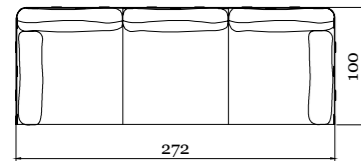
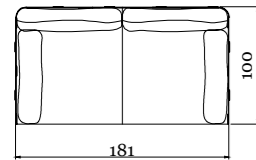

Elemento con 1 bracciolo
Unit with 1 armrest

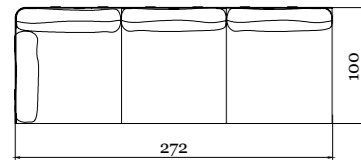
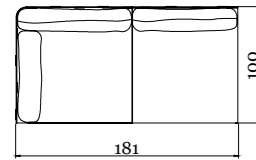

Elemento angolo
Corner unit

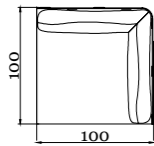

Chaise longue con 1 bracciolo
Chaise longue with 1 armrest

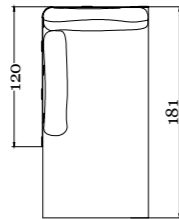

Pouf

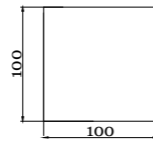

pg.186-187

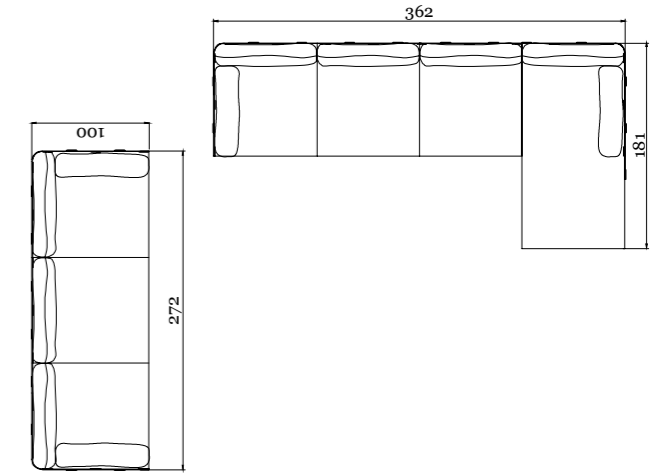

in the picture/in foto 102/10 + NT14 + bronzo/bronze
B3_ 6082/362 cm362x181xH85 + **6082/272** cm272x100xH85

pg.188/189

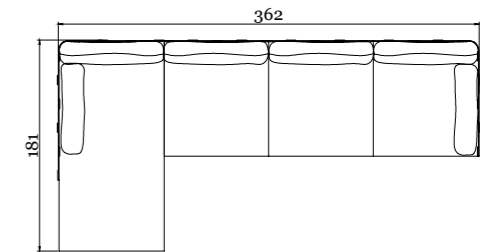

in the picture/in foto: NP06 + NP15 + bronzo/bronze
B3_ 6082/362 cm362x181xH85

pg.192/193

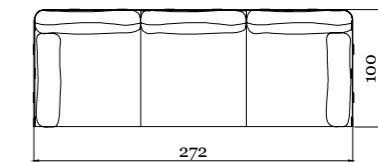

in the picture/in foto: NP06+ cuoio marrone/brown hide + bronzo/bronze
6082/272 cm272x100xH85

CLUB

Collezione di imbottiti caratterizzata dalla trafilatura in ottone spazzolato o bronzo che intercalata alla pelle crea una piacevole modularità.
A range of upholstered furniture characterised by brushed brass and bronze drawn tubes that, combined with the leather, create a stylish pattern.



Divani
Sofas

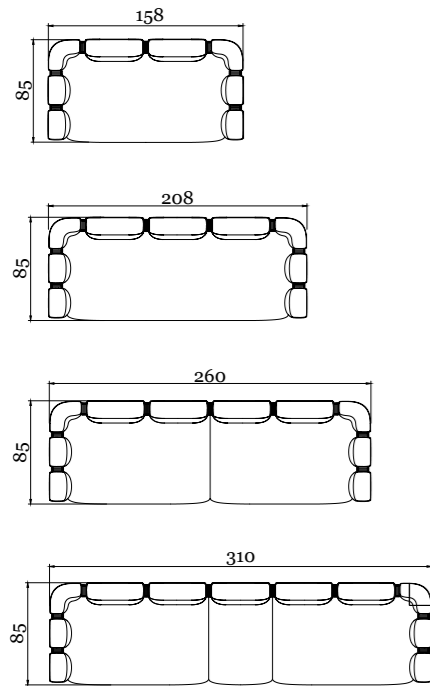

pg.156-159

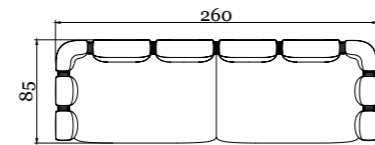

in the picture/in foto: NP 06 + ottone spazzolato/brushed brass
6202/260 cm260,6x85xH71

FREUD

Collezione di imbottiti componibile. Caratterizzata dai pannelli ricamati dei fianchi e dello schienale. Nella componibilità sono presenti anche dei tavolini di servizio.
A range of modular sofas and armchairs. Characterised by the "Baguette" stitching on the outer sides and outer backrest. Modules includes middle side table.



Elemento con un bracciolo
Unit with 1 armrest

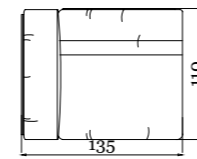

Elemento centrale
Central unit

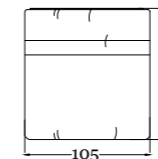

Elemento angolo
Corner unit

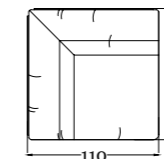

Chaise longue con 1 bracciolo
Chaise longue with 1 armrest

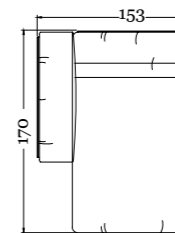

Pouf

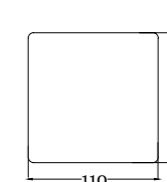

Tavolino
Coffee table

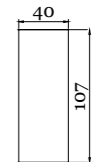

Tavolino
Coffee table

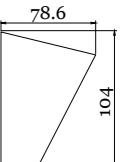

pg.198-199



pg.202-203

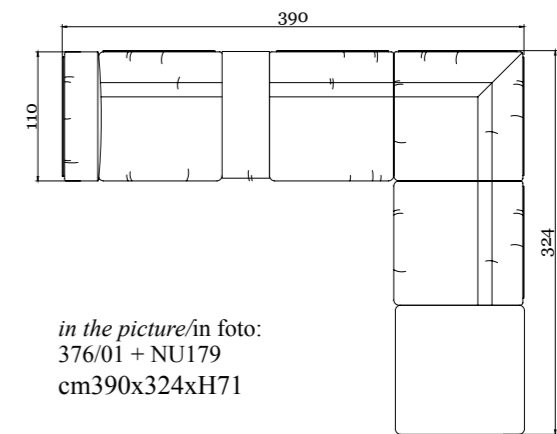

in the picture/in foto:
 376/01 + NU179
 cm390x324xH71

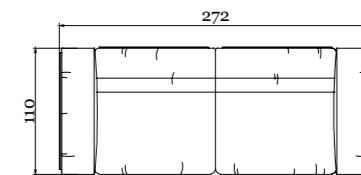

in the picture/in foto: 102/10 + NP 06
F1_6084/F1 cm272x110xH68

INFINITY

La serie di tubolari accostati e curvati da vita alla seduta, resa confortevole dai cuscini seduta e schienale.
 Struttura disponibile in oro lucido o cromo nero.
The name identifies the main design trait, a sinuous and continuous shape. The infinity concept is also recurrent in the glossy gold or dark chrome hand-finished components of the structure, which constantly repeat to create an unique, sculptures-like piece.



Elemento singolo
 Single unit

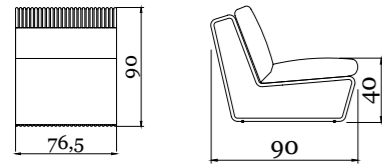

pg.196/197

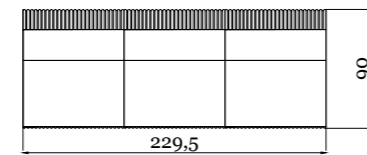

in the picture/in foto: S5005 + cromo nero/black chrome
C1_6100/C1 cm229,5x90xH66

MANTA

Collezione di imbottiti completamente rivestiti. Caratteristica principale lo schienale morbido e sinuoso che rende ogni seduta avvolgente e accogliente. Lo schienale è arricchito da cuciture artigianali.
Range of completely upholstered furniture characterised by a soft and sinuous backrest, enriched by stitching, that creates an extremely comfortable and welcoming seat.



Divani
 Sofas

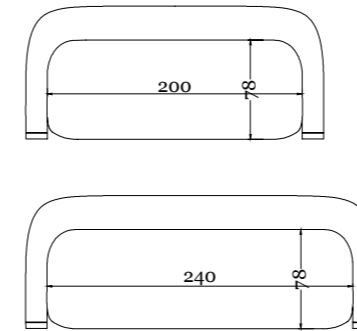

Chaise longue con 1 bracciolo
 Chaise longue with 1 armrest

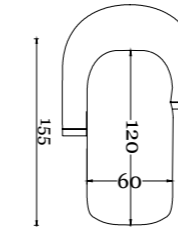

pg.208/209

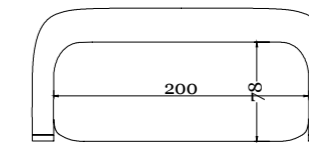

in the picture/in foto: NP 06
6089/240 cm245x105xH93

LUZ

Collezione di imbottiti con dettaglio in ottone spazzolato sul bracciolo e una serie di plisse sullo schienale disposti in modo armonico.
A range of upholstered furniture characterised by a brushed brass detail on the armrests and a serie of harmoniously-disposed pliss on the backrest.



pg.162/165

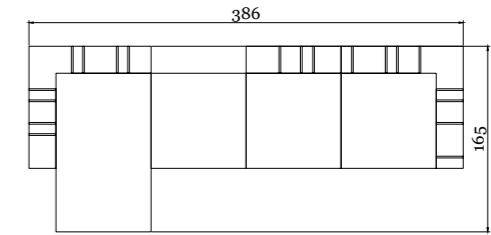

in the picture/in foto: NP 06 + 1050/075 + ottone spazzolato/brushed brass
C5_6208/C5 cm388x165xH67

Elemento con un bracciolo
Unit with 1 armrest

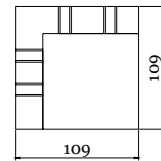

Elemento centrale
Central unit

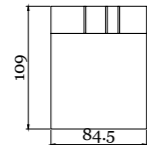

Chaise longue con 1 bracciolo
Chaise longue with 1 armrest

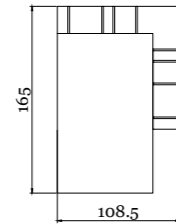

Pouf

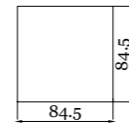

pg.166/167

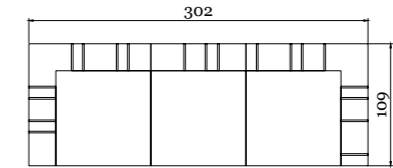

in the picture/in foto: NP16 + ottone spazzolato/brushed brass
C2_6208/C2 cm303x109xH67

NAUTILUS

Collezione di imbottiti componibile. Braccioli o schienali attrazzabili con librerie o mensole porta oggetti. Ad arricchire le composizioni anche un tavolino con vano a giorno. Dettaglio delle versioni in pelle la cucitura con taglio vivo.
Range of modular sofas characterised bookshelf-armrests, shelves-backrests and side table units. Also features raw-cut leather.



Elemento con un bracciolo
Unit with 1 armrest

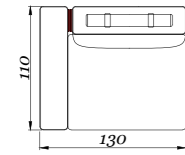

Elemento con un bracciolo
Libreria
Unit with 1 armrest

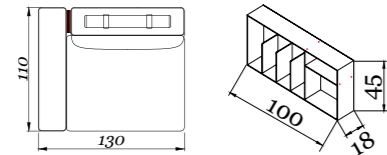

Elemento centrale
Central unit

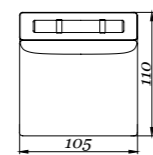

Elemento angolo
Corner unit

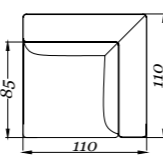

Chaise longue con 1 bracciolo
Chaise longue with 1 armrest

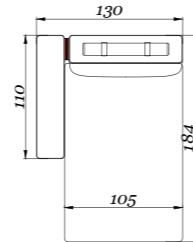

Pouf

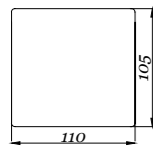

Mensola
Shelves

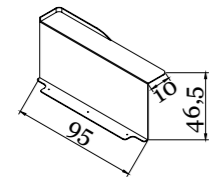

Tavolino
Coffee table

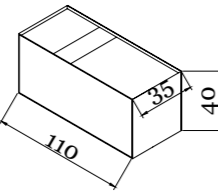

pg.134/137

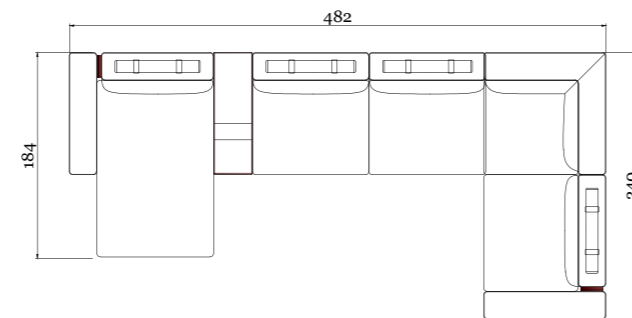

in the picture/in foto: 2841/092 + ottone spazzolato/brushed brass

pg.138/139

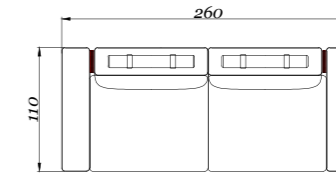

in the picture/in foto: NP24 + ottone spazzolato/brushed brass
C1_6200/C1 cm260x110xH85

pg.142/145

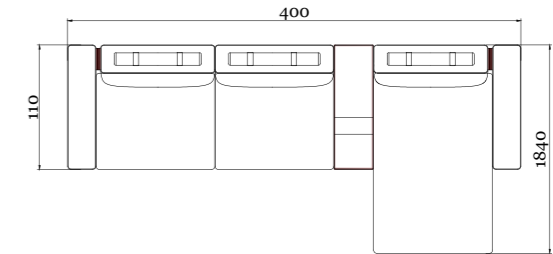

in the picture/in foto: 08 OASI + ottone spazzolato/brushed brass

pg.146/149

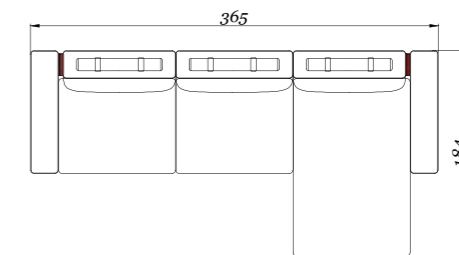

in the picture/in foto: 08 OASI + ottone spazzolato/brushed brass
C3_6200/C3 cm365x184xH85

PARIS



Divani
Sofas

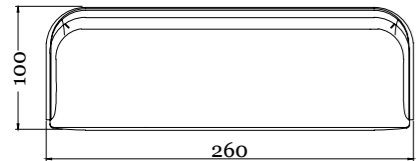
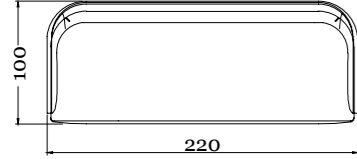
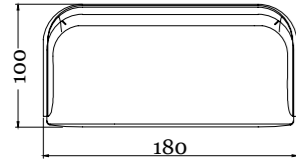

Collezione di sedute. Superficie esterna disponibile liscia o completamente ricamata con motivo matelassé che la rende originale. Cuscini-schienale in grande formato aumentano il comfort di seduta.

Ad incorniciare il tutto, la struttura in bronzo o rivestita cuoio.
A range of seating elements characterised by a twisted structure, finished in bronze or upholstered.
Outer surface available plain or with matelassé pattern.
Back cushions to improve the comfort complete the item.

pg.178/179



pg.180/181

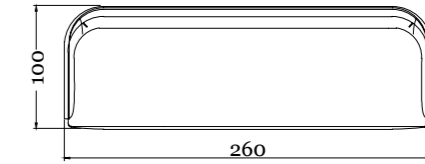

in the picture/in foto: ANTIQUE BLACK + cuoio nero/black cuire
6080/260 cm260x100xH81

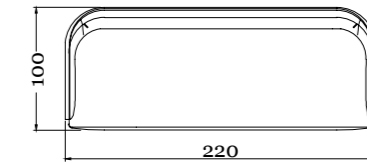

in the picture/in foto: + bronzo/bronze
6080/220 cm220x100xH81

PIERRE

Collezione di imbottiti componibile. I terminali e l'elemento ad angolo curvati permettono di creare composizioni sinuose e particolari. La seduta liscia o nella versione con ricami lineari.
Range of modular sofas. Curved end-modules and corner-modules help create unique and sinuous compositions. Seat available with linear stitching.



pg.122/125

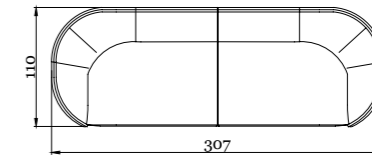

in the picture/in foto: NP 06 + bronzo/bronze
C2_ 6098/307 cm307x110xH71

Elemento con un bracciolo
Unit with 1 armrest

Elemento centrale
Central unit

Chaise longue con 1 bracciolo
Chaise longue with 1 armrest

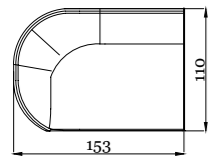
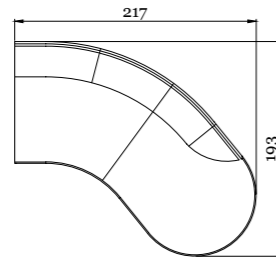
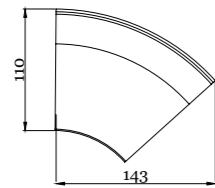
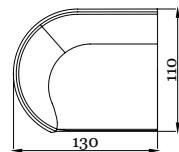

pg.126/129

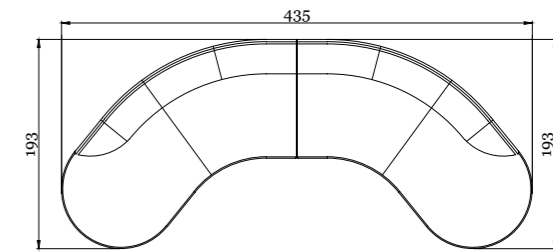

in the picture/in foto: 2841/070 + bronzo/bronze
C4_ 6098/435 cm435x193xH71

pg.118/121

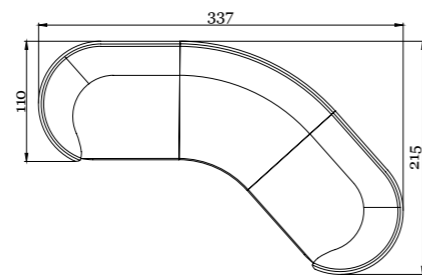

in the picture/in foto: 24 POLVERE + bronzo/bronze
C5_ 6098/337 cm337x216xH71

pg.130/131

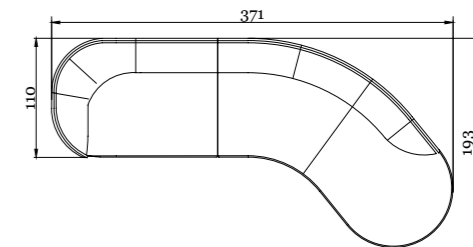

in the picture/in foto: 02 CANAPA + bronzo/bronze
C3_ 6098/A371 cm371x193xH71

VOGUE

Collezione di imbottiti componibili, dettagli in cuoio o nabuk, struttura liscia o con ricamo a "baguette"
Range of modular upholstered furniture with saddle leather or nubuck detail. Structure available plain or with "baguette" stitching



Divani
Sofas

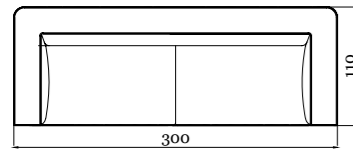
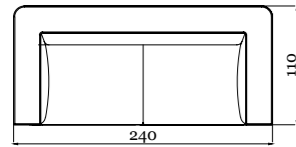

Elemento con un bracciolo
Unit with 1 armrest

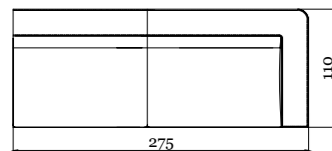
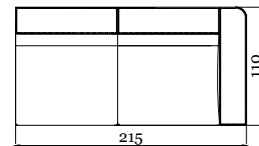

Chaise longue con 1 bracciolo
Chaise longue with 1 armrest

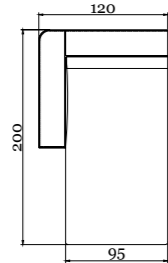

pg.168/169



in the picture/in foto: 25 FUMO + cuoio + bronzo/bronze
6017/300 cm300x110xH72

pg.170/171

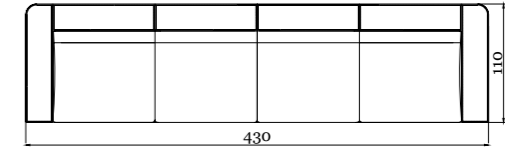

in the picture/in foto: NP24 + cuoio + bronzo/bronze
6017/430 cm430x110xH72

pg.172/173

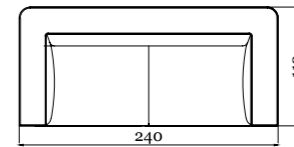

in the picture/in foto: NP06 + cuoio + bronzo/bronze
6017/240 cm240x110xH72

ARMCHAIRS | POLTRONE

AGATA pg.222/223



Poltrona imbottita con base rivestita in pelle liscia o stampata.
Armchair with upholstered legs and bronze details

6087/P cm76x84xH85

CLUB pg.228/229



Poltrona caratterizzata dalla trafilata in ottone spazzolato o bronzo che intercalata alla pelle crea una piacevole modularità.
Armchair characterised by brushed brass and bronze drawn tubes that, combined with the leather, create a stylish pattern.

6202/95 cm95,5x85xH71

COCO pg.218/221



Poltrona rivestita in pelle. Caratterizzata da una doppia scocca e base in oro satinato o cromo nero.
Armchair upholstered in leather. It features a double frame and a structure in satin gold or black chrome

6210 cm72x69xH85

GIOTTO pg.214/217



Serie di pouf imbottiti e rivestiti con il particolare schienale sagomato, disponibile nella versione liscia o capitonné.
Range of upholstered pouffs with the unique moulded backrest, available plain or with capitonné

5043 cmø62/70xH45/76
5043/100 cmø98xH42/80
5043/150 cmø150xH42/80

HARRY pg.240/241



Serie di pouf imbottiti e rivestiti con dettagli in oro satinato. Particolare il bottone centrale applicato nella seduta. La collezione spazia dal classico pouf, al pouf con schienale all'innovativo pouf con piccolo tavolino annesso.

Range of upholstered pouffs with satin gold details. Featuring a button in the centre of the seat. The range includes a classical pouff, a pouff with armrest and an innovative pouff with incorporated side table

6215 cmø50xH43
6215/T cmø50xH43/70
6215/S cmø58xH74

MARINA IN pg.224/227



Poltrona con struttura in metallo verniciato e corda in velluto intrecciata a mano. Gli intrecci sono alleggeriti dai piccoli vuoti che creano un gioco di luce e ombra.

Armchair with varnished metal structure and hand-braided velvet rope. The braided texture is combined with narrow empty spaces, to create a light and shadow play.

6212 cm80x92xH65

OPERA pg.232/235



Poltrona imbottita e rivestita con superficie esterna disponibile liscia o completamente ricamata con motivo matelassé che la rende originale.

Upholstered armchair featuring round and soft edges. Outer surface available plain or with matelassé pattern.

6090/90 cm90x100xH80
6090/69 cm69x82xH70

PARIS pg.236/239



Poltrona con superficie esterna disponibile liscia o completamente ricamata con motivo matelassé che la rende originale.

Ad incorniciare il tutto, la struttura in bronzo o rivestita cuoio. Armchair characterised by its twisted structure, finished in bronze or upholstered. Outer surface available plain or with matelassé pattern.

6080/90 cm90x100xH81
6080/69 cm69x82xH70

PERLA pg.230/231



Poltrona imbottita e rivestita. Parte posteriore disponibile liscia o ricamata, dettaglio zip su tutto il perimetro dello schienale. Piedini in metallo.
Upholstered armchair. Outer surface available plain or with patterned stitching. Metal feet

6088 cm89x80xH64,5

DECORO pg.268/269



Collezione di tavolini caratterizzati dal piano decoro. Diverse misure e diverse colorazioni disponibili. I piani decoro sono unici perchè fatti esclusivamente a mano da esperti artigiani.
Range of coffee table featuring a DECORO top, entirely hand-painted by expert craftsmen. Available in a range of dimensions.

- 9053/R130** cm130x80xH30
- 9053/R150** cm150x100xH30
- 9053/R180** cm180x140xH30
- 9053/Q120** cm120x120xH30
- 9053/Q140** cm140x140xH30
- 9053/D120** cm ø120xH30
- 9053/D140** cm ø140xH30

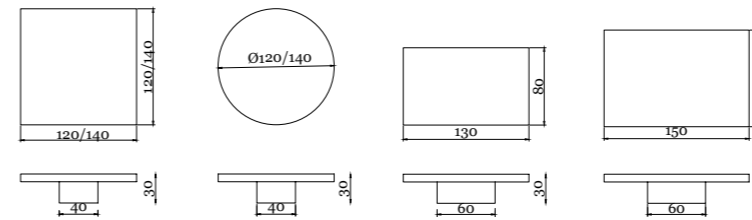

COFEE TABLES | TAVOLINI

CIGLIA pg.260/261



Collezione di tavolini in diverse misure e altezze. Base caratterizzata da una sequenza regolare di tondini in metallo. Piani in marmo e dettaglio in pelle stampata o liscia.
Base characterised by a sequence of individually hand-welded, small, round, metal tubes. Top available in marble with upholstered detail. Available in a range of dimensions.

- 9093/51** cm ø51xH49
- 9093/72** cm ø72xH29
- 9093/92** cm ø92xH39

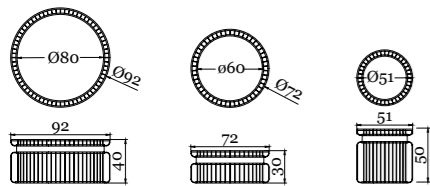

FIELD pg.242/243



Collezione di tavolini con piano completamente in metallo bronzato. Creato da diverse lastre accostate a creare movimenti geometrici.
Range of coffee tables with hand-brushed bronze metal top. The different directions of the panels create geometrical and light plays.

- 9002Q** cm140x140xH31
- 9002R** cm180x90xH31

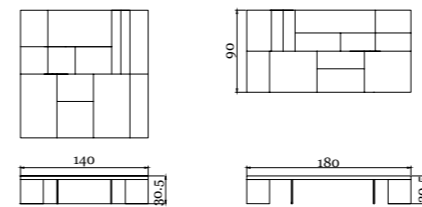

FOREST pg.246/247



Oro lucido o cromo nero caratterizzato le gambe importanti. Piani disponibili in diverse misure in legno, marmo, rivestiti in pelle o decorati.
Gloss gold or black chromed legs composed by skilfully welded tubes. The top is available in a variety of dimensions and can be decorated, made out of wood or marble or upholstered in leather.

9045/110 cm110x110xH33
9045/140 cm140x140xH33
9045/160 cm160x110xH33
9045/180A cm180x90xH33
9045/180 cm180x140xH33
9045/240 cm240x120xH33
9045/300 cm300x120xH33

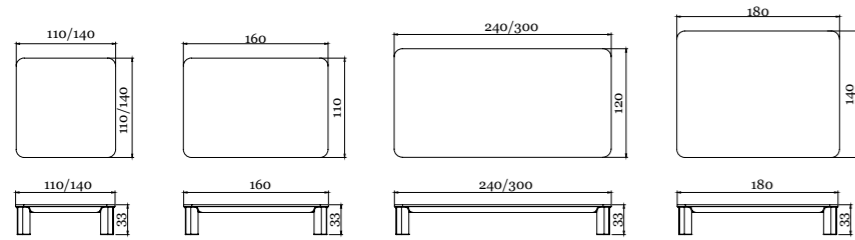

GATSBY pg.256/257



Collezione di tavolini con base in bronzo o cromo nero, fanno parte della collezione omonima di lampade. Piani in diverse misure in legno, rivestiti in pelle, marmo o decorati.
Range of coffee tables with bronze or black chrome finished based – sharing the base design with the Gatsby lamp range. Top available in wood and marble, hand-painted or upholstered in leather.

9002/31 cm ø60xH31
9002/38 cm ø60xH38
9002/85 cm ø85xH38

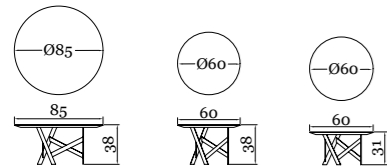

GLOBO pg.262/265



Tavolini di servizio, adatti a divani e poltrone. Versatili e disponibili con struttura acciaio o bronzo con piani in legno, rivestiti in pelle, marmo o decorati.
Side tables for armchairs and sofas. Versatile and adaptable to a broad spectrum of interiors, they are available with a bronze or chromed steel structure, with top in wood, marble, hand-painted or upholstered in leather

9004/T58 cm ø45xH58
9004/T73 cm ø45xH73
9004/R58 cm50x30xH58
9004/R73 cm50x30xH73
9004/C58 cm50x30xH58
9004/C73 cm50x30xH73

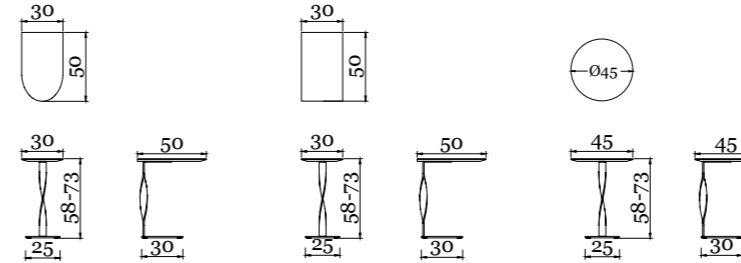

LIBERTY pg.248/249



Collezione di tavolini caratterizzati dalla base a colonna, un estruso in alluminio con finitura bronzo. Piani tondi di diverse misure.
Small table characterised by the column-like base, an aluminium extrusion finished in bronze. Round tops available different sizes.

9015/B5850 - 9015/C5850 - 9015/G5850 cm ø50xH58
9015/B5860 - 9015/C5860 - 9015/G5860 cm ø60xH58
9015/B4850 - 9015/C4850 - 9015/G4850 cm ø50xH48
9015/B4860 - 9015/C4860 - 9015/G4860 cm ø60xH48

9015/B3850 - 9015/C3850 - 9015/G3850 cm ø50xH38
9015/B3860 - 9015/C3860 - 9015/G3860 cm ø60xH38

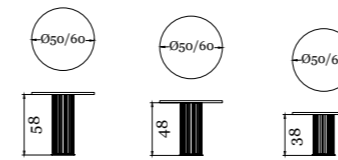

MOON pg.244/245



Forma tonda e diversi livelli per i piani superiori, tutti con profili in bronzo, disponibili nella combinazione pelle e marmo o ebano e pelle.
Round shape and half-round tops with bronze profiles, available with marble and leather or marble and ebony combination.

9090/140 cm ø140xH34

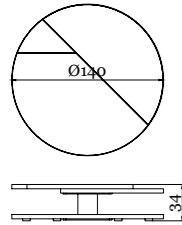

SIXTY pg.250/255



Basi in ottone spazzolato. Caratteristica la trafila che da vita alle gambe. Diverse altezze, piani tondi ed un ovale irregolare disponibili in marmo o decorati.
Base in brushed brass. characterised by a brushed brass and bronze drawn tubes structure. Available in a variety of dimensions with round and oval hand-painted or marble. tops,

9092/140 cm 140x72xH29
9092/70 cm ø70xH38
9092/50 cm ø50xH48

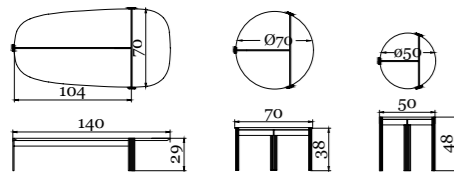

SPACE pg.258/259

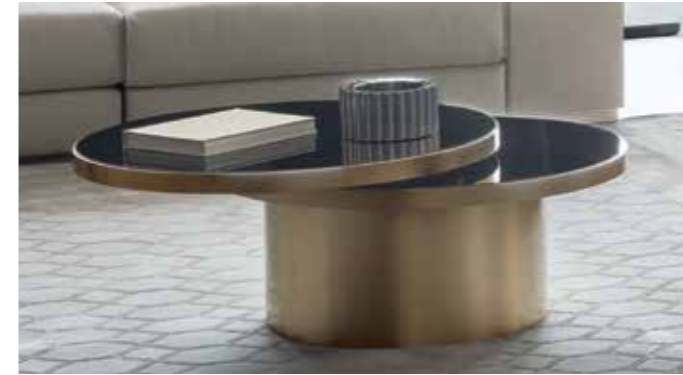

Ottone satinato per la base centrale, due piani in vetro nero dinamici e multifunzionali che si sovrappongono a composizione chiusa.
Satin brass base and detailing, characterised by two movable black glass tops that can overlap

9091/87OS cm ø87xH38 (ingombro massimo/size space 133cm)
9091/50OS cm ø50xH38 (ingombro massimo/size space 76cm)

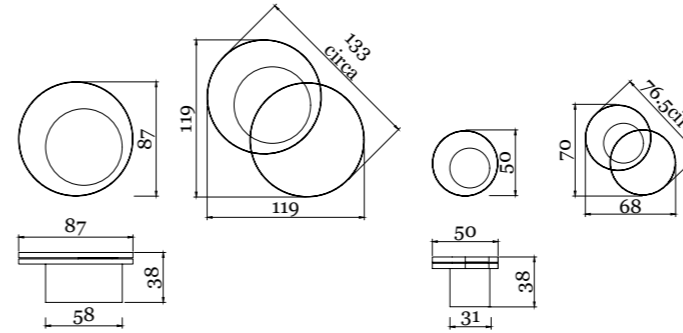

ZOE pg.266/267



Tavolino scultoreo, base in fusione di bronzo. Piano tondo o ovale disponibili in legno, rivestiti in pelle, decorati e marmo.
Elegant and sculptural side table with a bronze fusion base. Top available in wood and marble, hand-painted or upholstered in leather.

9082/88 cm 88x52xH58
9082/60 cm ø60xH58

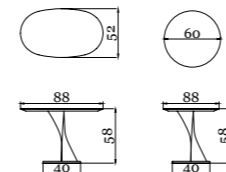

CONSOLE

ABSOLUTE pg.274/275

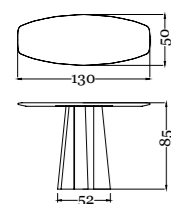

Console con base scultura creata dalla contrapposizione di due materiali bronzo ed oro lucido, oppure cromo nero e acciaio. Piani disponibili in diverse forme e misure in legno, marmo o decorati.

Console with sculptural base, created by the contrast of the two metal elements, finished either in bronze and glossy gold or in black chrome and chromed steel. Top available in a variety of finishes, including hand-painted, wooden and marble.

in the picture/in foto:

cromo nero e acciaio/black chrome and steel + valentine grey

4052/160 cm 130x50xH85

PURE pg.276/277

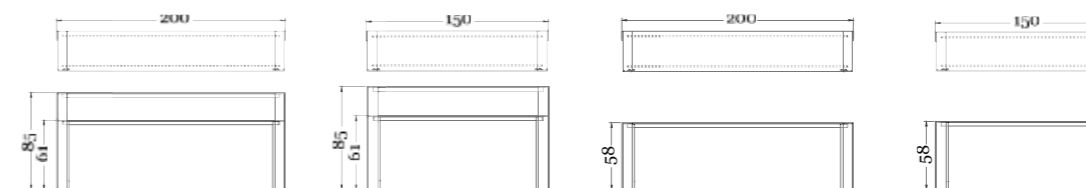

Linee essenziali compongono la console. Due piani in vetro incorniciati dalla struttura in bronzo.

Clear cut and essential lines characterize this console, composed by two glass tops framed by the bronze structure.

4054/200 cm 200x35xH85

4054/150 cm 150x35xH85

4056/200 cm 200x35xH58

4056/150 cm 150x35xH58

FOREST pg.270/271



Oro lucido o cromo nero caratterizzato le gambe importanti. Piani disponibili in diverse forme e misure in legno, marmo, rivestiti in pelle o decorati.

Gloss gold or black chromed legs composed by skilfully welded tubes. The top is available in a variety of dimensions and can be decorated, made out of wood or marble or upholstered in leather.

in the picture/in foto: cromo nero/black chrome + calacatta gold

4045C/160 cm 160x60xH75

4045C/210 cm 210x60xH75

4045C/240 cm 240x60xH75

4045C/300 cm 300x60xH75

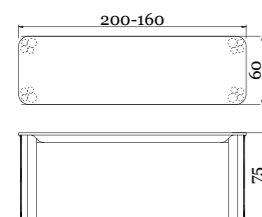

REA pg.272/273



Console con due fusioni in bronzo come base.

Piano in legno, rivestiti in pelle, decorati e marmo.

Console composed by two sculptural bronze fusion elements as a base and an oblong oval top, available in wood and marble, hand-painted or upholstered in leather.

in the picture/in foto: bronzo/bronze + patagonia

4031/C3 cm 160x45xH58

4031/C4 cm 200x45xH58

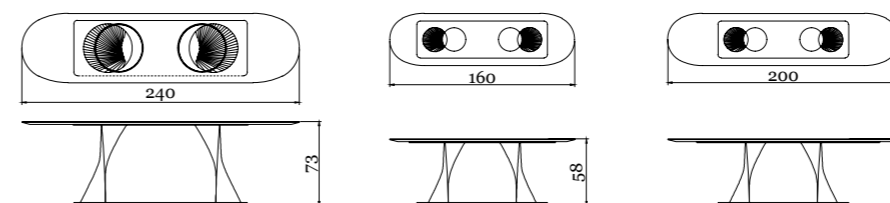

MIRRORS | SPECCHI

BOHEME pg.278/279

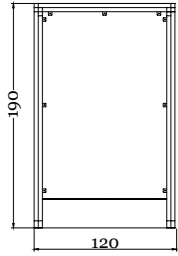

Cornice in metallo rivestita in pelle liscia o stampata. Dettagli in ottone lucido o bronzo.
Smooth or printed leather with a metal frame finished in bronze or gloss brass.

6090 cm120x4,5xH191

OFELIA pg.280/281

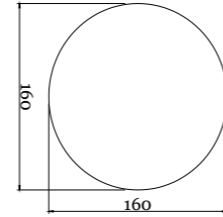

Cornice in bronzo con dettagli in ottone lucido.
Bronze frame with glossy brass details

6091 cm ø160x4

MONTECARLO pg.282/283



Cornice in bronzo leggermente bombata per la collezione di specchi dalle forme irregolari.
For the collection of irregular shapes mirrors, bronze frame slightly rounded

6095/1 cm80x5,5xH79

6095/2 cm65x5,5xH100

6095/3 cm60x5,5xH120

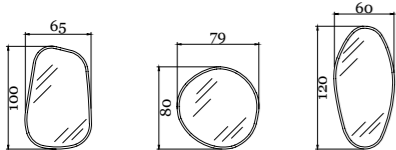

LIGHTS | LUCI

BIJOUX pg.288/293

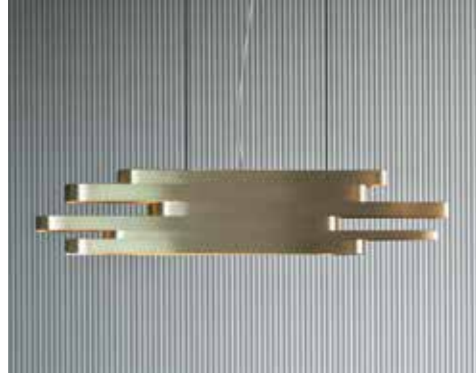

Ampia collezione di lampade in ottone, dalla sospensione alla lampada da tavolo. Forme lineari armoniosamente accostate.
Wide range of brass lamps, including wall lamps and table lamps where linear and round lines create harmonious shapes.

8016/150 cm150x10xH29,5



8016/A cm47,5x14xH29,5



8016 cm47,5x10xH29,5



8016/60 cm47,5x10xH60

DUO pg.286/287



Appliques in ottone disponibili in due misure e ideali per composizioni a parete.
Brass wall lamps available in two different sizes and ideal for wall compositions.

8017/A cm ø40x13,5
8017/A28 cm ø28x13,5

ECLIPSE pg.310/311



Appliques in ottone disponibili in tre misure e ideali per composizioni a parete. Luce radente.
Brass wall lamps available in two different sizes and ideal for wall compositions. Oblique light

8018/50 cm ø50x12
8018/75 cm ø75x12
8018/94 cm ø94x12

GATSBY pg.302/303



Collezione di lampade con base in bronzo o cromo nero, fanno parte della collezione omonima di tavolini caratterizzata dalla base a traliccio.
Range of lamps with bronze or black chrome base – sharing the framework-like base design with the Gatsby lamp range.

8017/77 cm ø40xH77
8017/150 cm ø50xH150

HALO pg.304/309



Collezione di lampade in bronzo con dettagli ottone lucido, dalla sospensione alla lampada da tavolo. Gli anelli sono utilizzati singolarmente o in composizioni armoniche.
Range of bronze lamps with glossy gold details, also including wall and table lamp. The rings can be used individually or to create harmonious compositions.

8097/60V cm ø60x3,5
8097/75V cm ø75x3,5
8097/100V cm ø100x3,5
8097/120V cm ø120x3,5



8097/100 cm100x90



8097/O cm150x80



8097/38 cm38,5x7xH53



8097/35 cm35x7xH31,5

LIBERTY pg.301



Collezione di lampade con base a colonna, un estruso in alluminio con finitura bronzo, cromo nero o oro lucido.
Diversi i paralumi tutti in vetro, in tessuto o sferico in vetro.
Range of lamps characterised by the column-like base, an aluminium extrusion finished in bronze, black chrome or glossy gold. Lampshade available in smoked glass, fabric or white glass in a round shape.

8015/40 cm ø45xH40

LIBERTY P pg.300



8015/60 cm ø40xH60

LIBERTY SOFT pg.298/299



8015/40S cm ø45xH40

TRILOGY pg.294/295



Collezione di lampade in alluminio spazzolato e ottone. Gli anelli di diverse misure sono utilizzati singolarmente in orizzontale o verticale o in composizioni armoniche.
Range of lamps finished in brushed aluminium or brass. The rings can be used individually or to create harmonious compositions.

8099/3B cm ø90xH130 max

SOLITARIO V pg.296/297



8099/70V cm ø70xH200 max
8099/90V cm ø90xH200 max
8099/120V cm ø120xH200 max

METALS | METALLI



Bronze
Bronzo



Black chrome
Cromo nero



Steel
Acciaio



Glossy brass
Ottone lucido



Brushed brass
Ottone spazzolato

WOODS | ESSENZE



Ebony
Ebano



Eucalyptus
Eualipto



Wengè oak
Rovere tinto wengè

MARBLES | MARMI



Calacatta gold



Emperador dark



Marquina black



Valentine grey



Black and gold

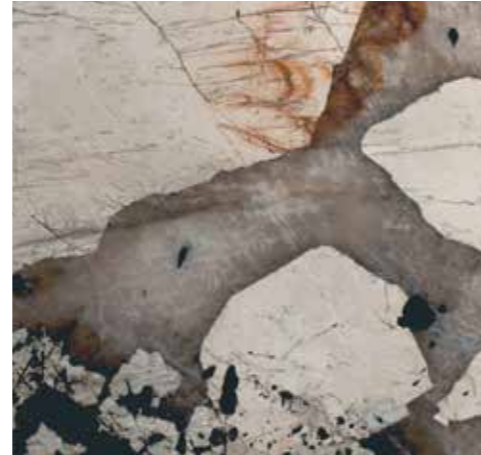

Patagonia



Lepanto red



Guatemala green



Cipollino

EMBROIDERY | RICAMI



Matelassè

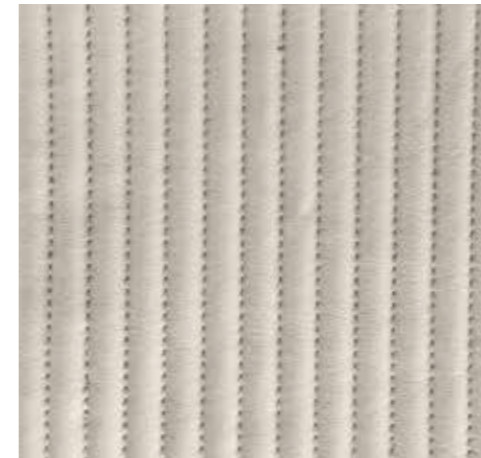

Baguette



Spigato



Onda



Elle

DECORO



Pedro



Bombay

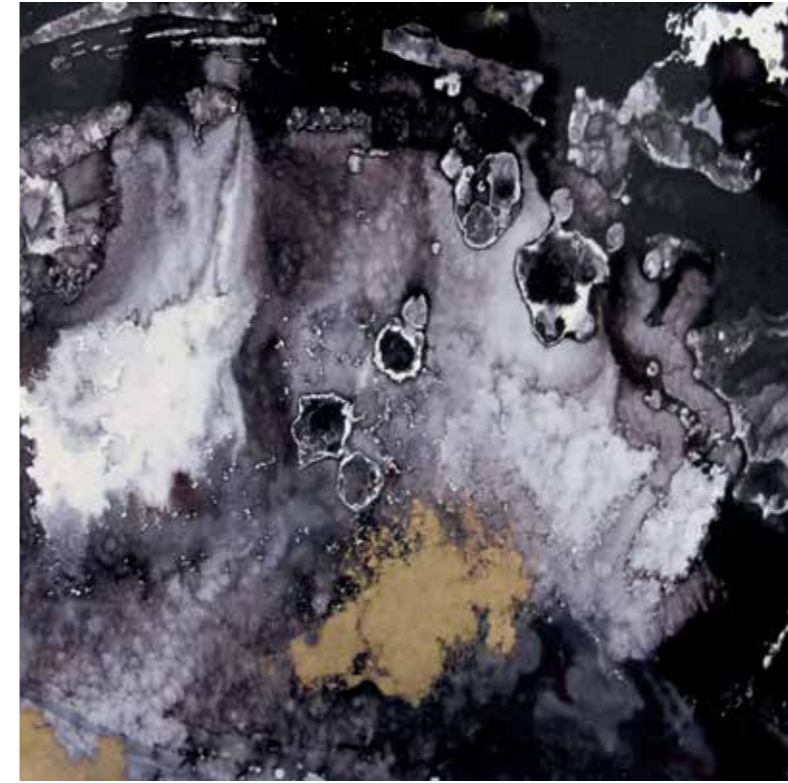

Vasco

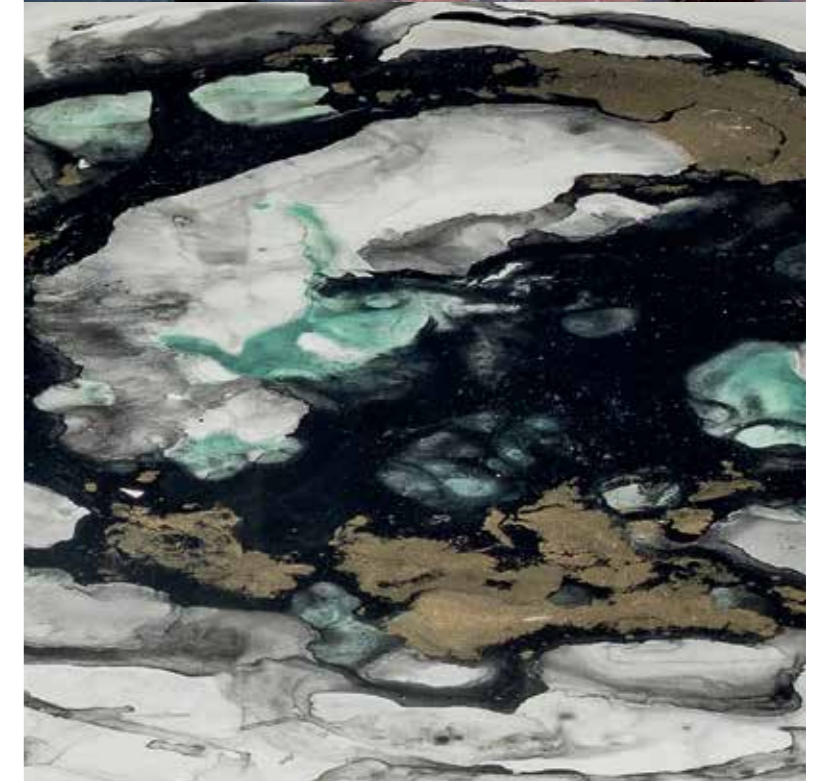

Botticelli 2019

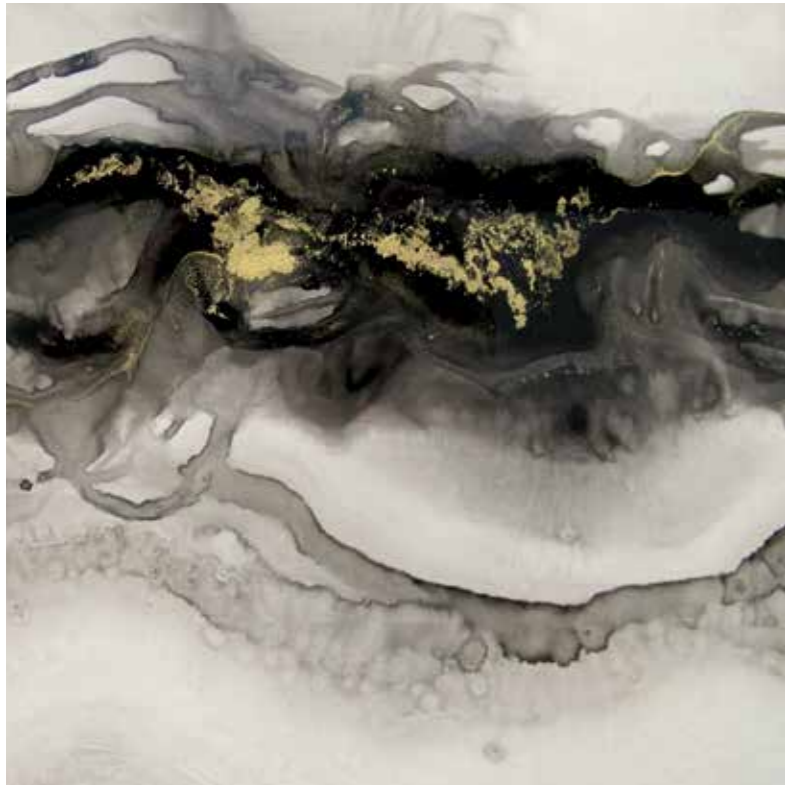

Botticelli Nero e Oro



Botticelli 2013

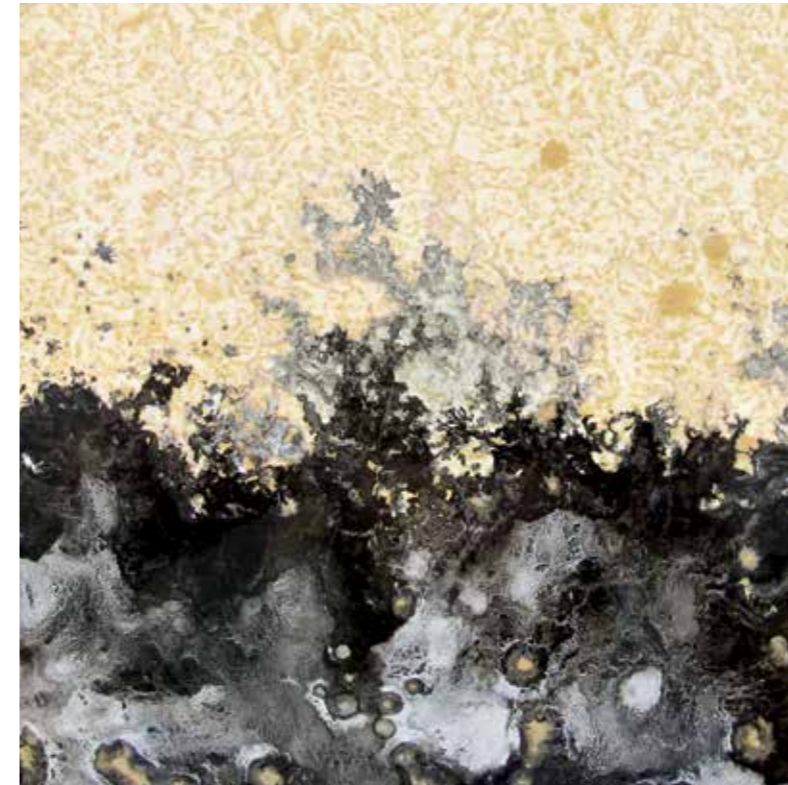

Monet



Van Gogh

Le immagini e i colori in foto potrebbero non essere pienamente corrispondenti a quelli reali; le immagini hanno infatti funzione puramente indicativa.
The images and colors of the pictures may not fully correspond to the real ones; the images are in fact purely indicative.

Via per Cascina Amata 9
22066 Mariano Comense (CO) Italy
Tel. +39 031 752378
Fax. +39 031 752382
rugiano@rugiano.it

rugiano.com