





# VITOLUPO

2020

LISTINO TECNICO  
TECHNICAL DATA



## LA CAMERA DA LETTO · THE BEDROOM

IL CILIEGIO	Letto variante 1 · Bed variant 1	8
	Letto variante 2 · Bed variant 2	10
LE GINESTRE	Comò variante 1 · Chest of drawers variant 1	12
	Comò variante 2 · Chest of drawers variant 2	14
	Comodino variante 1 · Bedside table variant 1	16
	Comodino variante 2 · Bedside table variant 2	18
	Toeletta variante 1 · Dressing table variant 1	20
	Toeletta variante 2 · Dressing table variant 2	22
	Pouf grande · Large pouf	24
	Pouf piccolo · Small pouf	26
IL CIRMOLO	Letto · Bed	28
LE TAMERICI	Comò · Chest of drawers	32
	Comodino · Bedside table	34
	Toeletta · Dressing table	36
	Scrittoio · Writing desk	38

## LA SALA DA PRANZO · THE DINING ROOM

IL GELSO	Tavolo rotondo · Round table	42
LA ROBINIA	Tavolo rotondo variante 1 · Round table variant 1	43
	Tavolo rotondo variante 2 · Round table variant 2	44
IL PLATANO	Tavolo ovale variante 1 · Oval table variant 1	45
	Tavolo ovale variante 2 · Oval table variant 2	46
	Tavolo ovale variante 3 · Oval table variant 3	47
	Tavolo ovale variante 4 · Oval table variant 4	48
IL CIPRESSO	Tavolo rettangolare · Rectangular table	49
LAGRIFOGLIO	Sedia variante 1 · Chair variant 1	50
	Sedia variante 2 · Chair variant 2	51
	Sedia variante 3 · Chair variant 3	52
L'OLEANDRO	Sedia · Chair	53
IL CORBEZZOLO	Poltroncina · Small armchair	54
IL PRUGNOLO	Sedia · Chair	56
	Poltroncina · Small armchair	57

LA QUERCIA	<b>Credenza</b> variante 1 · <b>Sideboard</b> variant 1	58
	<b>Credenza</b> variante 2 · <b>Sideboard</b> variant 2	60
	<b>Credenza</b> variante 3 · <b>Sideboard</b> variant 3	62
LA PALMA	<b>Credenza</b> · <b>Sideboard</b>	64
LA CAMELIA	<b>Credenza</b> · <b>Sideboard</b>	66

IL SALOTTO · THE LIVING ROOM

L'EUCALIPTO	<b>Divano</b> · <b>Sofa</b>	70
	<b>Poltrona</b> · <b>Armchair</b>	72
	<b>Poltrona</b> vis-à-vis con frangia · <b>Armchair</b> vis-à-vis with fringe	74
	<b>Poltrona</b> vis-à-vis · <b>Armchair</b> vis-à-vis	76
IL CASTAGNO	<b>Divano</b> · <b>Sofa</b>	78
	<b>Poltrona</b> · <b>Armchair</b>	80
LA MAGNOLIA	<b>Divano</b> · <b>Sofa</b>	82
IL FRASSINO	<b>Divano</b> · <b>Sofa</b>	84
	<b>Poltrona</b> · <b>Armchair</b>	86
IL TIGLIO	<b>Divano</b> · <b>Sofa</b>	88
LA BETULLA	<b>Poltrona</b> · <b>Armchair</b>	90
	<b>Poltrona</b> · <b>Armchair</b>	92
LAGRIFOGLIO	<b>Poltroncina lounge</b> variante 1 · <b>Lounge armchair</b> variant 1	94
	<b>Poltroncina lounge</b> variante 2 · <b>Lounge armchair</b> variant 2	96
	<b>Divanetto</b> variante 1 · <b>Loveseat</b> variant 1	98
	<b>Divanetto</b> variante 2 · <b>Loveseat</b> variant 2	100
IL MIRTO	<b>Mobile bar</b> variante 1 · <b>Bar cabinet</b> variant 1	104
	<b>Mobile bar</b> variante 2 · <b>Bar cabinet</b> variant 2	106
IL GINEPRO	<b>Mobile bar</b> · <b>Bar cabinet</b>	108
IL NOCE	<b>Libreria</b> singola variante 1 · Single <b>bookcase</b> variant 1	110
	<b>Libreria</b> singola variante 2 · Single <b>bookcase</b> variant 2	112
	<b>Libreria</b> doppia variante 1 · Double <b>bookcase</b> variant 1	114
	<b>Libreria</b> doppia variante 2 · Double <b>bookcase</b> variant 2	116
	<b>Libreria</b> doppia con ante variante 1 · Double <b>bookcase</b> with doors variant 1	118
	<b>Libreria</b> doppia con ante variante 2 · Double <b>bookcase</b> with doors variant 2	120
	<b>Moduli libreria</b> · <b>Bookcase modules</b>	122
IL MELOGRANO	<b>Paravento</b> modulo A · <b>Screen</b> module A	126
	<b>Paravento</b> modulo B · <b>Screen</b> module B	128
IL LAURO	<b>Paravento</b> · <b>Screen</b>	130

L'ALLORO	<b>Specchio · Mirror</b>	132
IL BOSSO	<b>Specchio · Mirror</b>	133
IL SAMBUCO	<b>Tavolino basso · Coffee table</b>	134
LA ROBINIA D'ORO	<b>Tavolino basso · Coffee table</b>	135
I RODODENDRI	<b>Tavolino basso · Coffee table</b>	136
	<b>Tavolino alto · Small table</b>	138
	<b>Consolle · Console</b>	140
	<b>Tavolino laterale · Side table</b>	142
I LILLA	<b>Tavolino basso · Coffee table</b>	143
	<b>Tavolino medio · Medium table</b>	144
	<b>Tavolino alto · Small table</b>	145
I NOCCIOLI	<b>Tavolino basso · Coffee table</b>	146
	<b>Tavolino piccolo · Small table</b>	147
GLI OLMI	<b>Tavolino basso quadrato · Coffee table square</b>	148
	<b>Tavolino basso rettangolare · Coffee table rectangular</b>	149
	<b>Tavolino alto · Small table</b>	150
L'ALBICOCCO	<b>Pouf · Pouf</b>	151

LO STUDIO · THE STUDY

IL LECCIO	<b>Scrivania · Writing desk</b>	154
IL CEDRO	<b>Scrivania variante 1 · Desk variant 1</b>	156
	<b>Scrivania variante 2 · Desk variant 2</b>	158
IL CARPINO	<b>Libreria variante 1 · Bookcase variant 1</b>	160
	<b>Libreria variante 2 · Bookcase variant 2</b>	162

LE FINITURE · FINISHES

	<b>Indicazioni generali · General indications</b>	166
--	---	-----





**LA CAMERA DA LETTO**  
THE BEDROOM

## IL CILIEGIO

### LETTO VARIANTE 1 | BED VARIANT 1

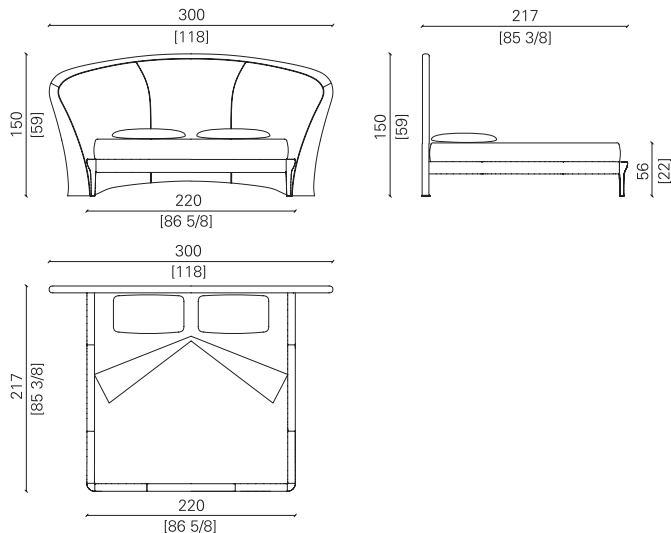

by Fabio Crippa & Joe Gentile

dimensioni   dimensions	L300 x P217 x H150 cm
peso   weight	160 kg
volume letto   bed volume	2,50 m <sup>3</sup>
volume testata   headboard volume	0,75 m <sup>3</sup>

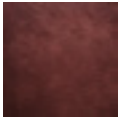

Letto con testata e giroletto imbottiti in pelle con cucitura a punto cavallo in contrasto. Gambe in fusione di bronzo. Compreso di rete ortopedica. Escluso materasso e set biancheria letto.

Bed with headboard and bedframe upholstered in leather with contrasting cross stitching. Cast bronze bed legs. Including orthopedic bedspring. Excluding mattress and bed linen.





finiture   finishes		quantità   quantity	prezzo   price
imbottitura in pelle con cucitura a punto cavallo upholstered in leather with cross stitching	 <p>+ altri colori + other colours</p> <p><b>ET5060</b> pelle leather</p>	27 mq	
gambe del letto bed legs	 <p><b>FU01</b> fusione di bronzo bronze casting</p>		
rete ortopedica orthopedic bedspring	dimensione rete per materasso 200 x 200 cm bedspring for 200 x 200 cm mattress		
composizioni   compositions	Totale escluso accessori. Total excluding accessories.		€ 16.480,00

Altre finiture disponibili su richiesta. | Other finishes available upon request.

## IL CILIEGIO

### LETTO VARIANTE 1 | BED VARIANT 1

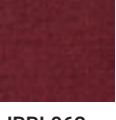
quantità | quantity    prezzo | price

cuscini   cushions	Imbottitura cuscini in piuma d'oca. Profilo in tinta o in contrasto. Ducks' down cushion filling. Matching or contrasting piping.			
<p>cuscino decorativo A 50x50 cm x 1pz decorative cushion A 50x50 cm x 1 pc</p>	 <p>+ altri colori + other colours</p>	<p>0,6 mtl</p> <p>€ 180,00</p>	<p><b>RULR002</b> tessuto fabric</p>	
<p>cuscino decorativo B 40x40 cm x 1pz decorative cushion B 40x40 cm x 1 pc</p>	 <p>+ altri colori + other colours</p>	<p>0,5 mtl</p> <p>€ 160,00</p>	<p><b>JBBL060</b> velluto velvet</p>	
<p>cuscino a rullo Ø18x60 cm x 1pz roll cushion Ø18x60 cm x 1 pc</p>	 <p>+ altri colori + other colours</p>	<p>1 mtl</p> <p>€ 260,00</p>	<p><b>JBBL062</b> velluto velvet</p>	
set biancheria   set of linen	<p>Set biancheria letto bicolore in raso di cotone 100%. Compreso di: n. 2 guanciali con n. 2 federe con bordo a volano in contrasto n. 1 lenzuolo con angolo n. 1 lenzuolo con bordo a volano in contrasto n. 1 piumino con n. 1 copripiumino bicolore</p> <p>Two-tone set of bed linen in 100% cotton satin Including: n. 2 pillows with n° 2 pillowcases, with contrasting frilly border n. 1 fitted sheet n. 1 flat sheet with contrasting frilly border n. 1 duvet with n. 1 two-tone duvet cover</p>		 <p>+ altri colori + other colours</p>	<p>€ 1.130,00</p>
<p>set biancheria letto bed linen set</p>	<p>beige chiaro con profilo beige più scuro light beige with darker beige border</p>			
materasso   mattress	<p>Materasso ortopedico. Orthopedic mattress.</p>	<p>su richiesta upon request</p>		

Altre finiture disponibili su richiesta. | Other finishes available upon request.

## IL CILIEGIO

### LETTO VARIANTE 2 | BED VARIANT 2

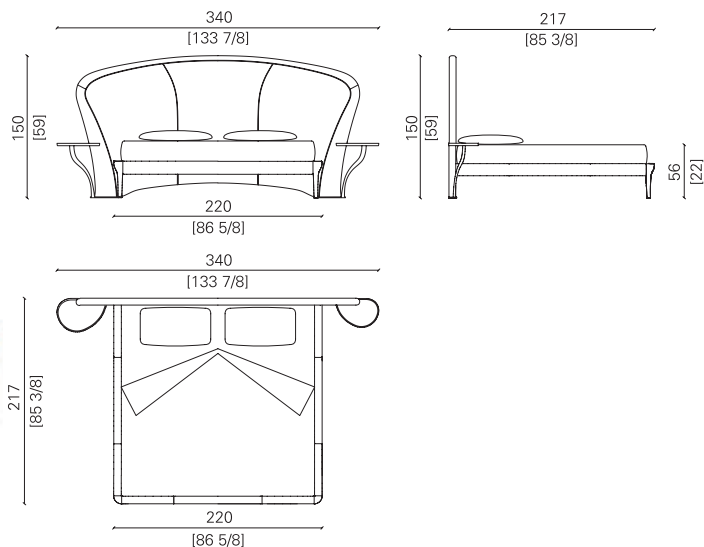

by Fabio Crippa & Joe Gentile

dimensioni   dimensions	L340 x P217 x H150 cm
peso   weight	185 kg
volume letto   bed volume	2,50 m <sup>3</sup>
volume testata   headboard volume	2,50 m <sup>3</sup>



Letto con testata e giroletto imbottiti in pelle con cucitura a punto cavallo in contrasto. Gambe e comodini integrati in fusione di bronzo. Compreso di rete ortopedica. Escluso materasso e set biancheria letto.

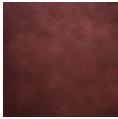



Bed with headboard and bedframe upholstered in leather with contrasting cross stitching. Cast bronze built-in bed legs and bedside tables. Including orthopedic bedspring. Excluding mattress and bed linen.

finiture   finishes		quantità   quantity	prezzo   price
imbottitura in pelle con cucitura a punto cavallo upholstered in leather with cross stitching	 <p>+ altri colori + other colours</p>	27 mq	
gambe del letto e comodini integrati built-in bed legs and bedside tables	 <p><b>FU01</b> fusione di bronzo bronze casting</p>		
rete ortopedica orthopedic bedspring	dimensione rete per materasso 200 x 200 cm bed base for 200 x 200 cm mattress		
composizioni   compositions	Totale escluso accessori. Total excluding accessories.		<b>€ 19.560,00</b>

Altre finiture disponibili su richiesta. | Other finishes available upon request.

**IL CILIEGIO****LETTO VARIANTE 2 | BED VARIANT 2**

quantità | quantity    prezzo | price

cuscini   cushions	Imbottitura cuscini in piuma d'oca. Profilo in tinta o in contrasto. Ducks' down cushion filling. Matching or contrasting piping.	
cuscino decorativo A 50x50 cm x 1pz decorative cushion A 50x50 cm x 1 pc	 <p>+ altri colori + other colours</p> <p><b>RULR002</b> tessuto fabric</p>	0,6 mtl    € <b>180,00</b>
cuscino decorativo B 40x40 cm x 1pz decorative cushion B 40x40 cm x 1 pc	 <p>+ altri colori + other colours</p> <p><b>JBBL060</b> velluto velvet</p>	0,5 mtl    € <b>160,00</b>
cuscino a rullo Ø18x60 cm x 1pz roll cushion Ø18x60 cm x 1 pc	 <p>+ altri colori + other colours</p> <p><b>JBBL062</b> velluto velvet</p>	1 mtl    € <b>260,00</b>
set biancheria   set of linen	Set biancheria letto bicolore in raso di cotone 100%. Compreso di: n. 2 guanciali con n. 2 federe con bordo a volano in contrasto n. 1 lenzuolo con angolo n. 1 lenzuolo con bordo a volano in contrasto n. 1 piumino con n. 1 copripiumino bicolore	
set biancheria letto bed linen set	<p>Two-tone set of bed linen in 100% cotton satin. Including: n. 2 pillows with n° 2 pillowcases, with contrasting frilly border n. 1 fitted sheet n. 1 flat sheet with contrasting frilly border n. 1 duvet with n. 1 two-tone duvet cover</p>  <p>+ altri colori + other colours</p> <p>beige chiaro con profilo beige più scuro light beige with darker beige border</p>	€ <b>1.130,00</b>
materasso   mattress		
materasso mattress	Materasso ortopedico. Orthopedic mattress.	su richiesta upon request

Altre finiture disponibili su richiesta. | Other finishes available upon request.

## LE GINESTRE

### COMÒ VARIANTE 1 | CHEST OF DRAWERS VARIANT 1

by Fabio Crippa & Joe Gentile

dimensioni | dimensions L150 x P52 x H94 cm  
 peso | weight 150 kg  
 volume | volume 1,05 m<sup>3</sup>

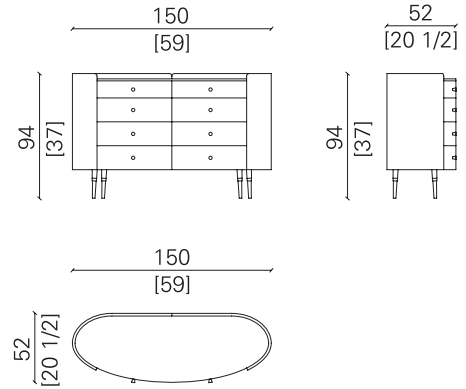

Comò con struttura in multistrato di pioppo curvato rivestito in pergamena color rubino in finitura lucida. Piano in onice Rosa Extra. Fondo cassetti rivestiti in pelle in tinta. Pomoli e puntali in ottone finitura bagno oro lucido.

Chest of drawers with a curved multi-ply poplar structure clad in ruby coloured parchment, with glossy finish. Top in Pink Extra onyx. Drawer bottoms lined in matching leather. Knobs and tips in brass with shiny gold plated finish.

#### finiture | finishes

piano in onice  
top in onyx



**OX03**  
onice Rosa Extra  
Pink Extra onyx



**OX04**  
onice White Extra  
White Extra onyx

A. finitura in pergamena lucida  
glossy parchment finish

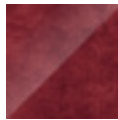

**PES01.G**  
pergamena lucida rubino  
glossy parchment  
ruby colour



**PE04.G**  
pergamena lucida naturale  
glossy parchment  
natural colour

+ altri colori  
+ other colours

B. finitura in laccato lucido  
glossy lacquered finish

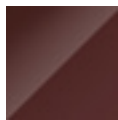

**LAS02.G**  
laccato lucido col. rubino  
glossy lacquered  
ruby colour



**LA06.G**  
laccato lucido col. avorio  
glossy lacquered  
ivory colour

+ altri colori  
+ other colours

Altre finiture disponibili su richiesta. | Other finishes available upon request.

## LE GINESTRE

### COMÒ VARIANTE 1 | CHEST OF DRAWERS VARIANT 1

quantità | quantity    prezzo | price

#### finiture | finishes

fondo cassetti in pelle  
drawer bottoms in leather

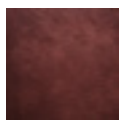

**ET5060**  
pelle  
leather



**ET5002**  
pelle  
leather

+ altri colori  
+ other colours

2 mq

pomoli e puntali in ottone  
knobs and tips in brass



**ME01**  
bronzato  
bronzed



**ME02**  
bagno oro  
lucido  
shiny gold  
plated



**ME03**  
satinato  
satin finish

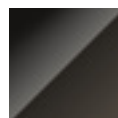

**ME04**  
cromo nero  
lucido  
shiny black  
chrome

#### composizioni | compositions

**A.** Comò in finitura pergamena lucida.  
Chest of drawers with glossy parchment finish.

€ 27.730,00

**B.** Comò in finitura laccato lucido.  
Chest of drawers with glossy lacquered finish.

€ 21.970,00

Altre finiture disponibili su richiesta. | Other finishes available upon request.

## LE GINESTRE

### COMÒ VARIANTE 2 | CHEST OF DRAWERS VARIANT 2





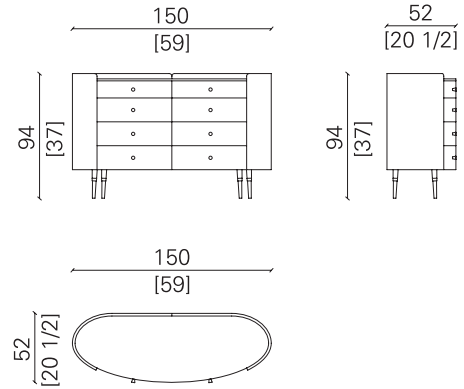

by Fabio Crippa & Joe Gentile

dimensioni | dimensions L150 x P52 x H94 cm  
 peso | weight 150 kg  
 volume | volume 1,05 m<sup>3</sup>

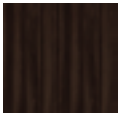

Comò con struttura in multistrato di pioppo curvato impiallacciato in noce americano naturale in finitura opaca. Piano in noce americano naturale in finitura opaca. Fondo cassetti rivestiti in pelle in tinta. Pomoli e puntali in ottone in finitura satinata.

Chest of drawers in curved multi-ply poplar, veneered in natural American walnut with matt finish. Top in natural American walnut with matt finish. Drawer bottoms lined in matching leather. Knobs and tips in brass with satin finish.

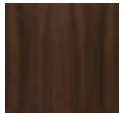
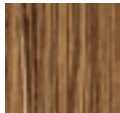
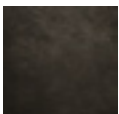
finiture   finishes					quantità   quantity
<b>A.</b> finitura in essenza di legno lucida glossy wood finish	 <b>PL01.G</b> palissandro scuro lucido glossy dark rosewood	 <b>NA01.G</b> noce amer. scuro lucido glossy dark American walnut	 <b>NA02.G</b> noce amer. naturale lucido glossy natural American walnut	 <b>ZB01.G</b> zebrano lucido glossy zebrawood	
<b>B.</b> finitura in essenza di legno opaca matt wood finish	 <b>PL01.M</b> palissandro scuro opaco matt dark rosewood	 <b>NA01.M</b> noce amer. scuro opaco matt dark American walnut	 <b>NA02L.M</b> noce amer. naturale opaco matt natural American walnut	 <b>ZB01.M</b> zebrano opaco matt zebrawood	
fondo cassetti in pelle drawer bottoms in leather	 <b>ET5085</b> pelle leather	+ altri colori + other colours			2 mq

Altre finiture disponibili su richiesta. | Other finishes available upon request.



## LE GINESTRE

COMÒ VARIANTE 2 | CHEST OF DRAWERS VARIANT 2

prezzo | price

### finiture | finishes

pomoli e puntali in ottone  
knobs and tips in brass



**ME01**  
bronzato  
bronzed



**ME02**  
bagno oro  
lucido  
shiny gold  
plated



**ME03**  
satinato  
satin finish



**ME04**  
cromo nero  
lucido  
shiny black  
chrome

### composizioni | compositions

- A.** Comò in finitura essenza di legno a scelta lucida.  
Chest of drawers with choice of glossy wood finishes.
- B.** Comò in finitura essenza di legno a scelta opaca.  
Chest of drawers with choice of matt wood finishes.

€ 19.380,00

€ 17.710,00

Altre finiture disponibili su richiesta. | Other finishes available upon request.

## LE GINESTRE

### COMODINO VARIANTE 1 | BEDSIDE TABLE VARIANT 1

by Fabio Crippa & Joe Gentile

dimensioni   dimensions	L61 x P42 x H60 cm
peso   weight	62 kg
volume   volume	0,26 m <sup>3</sup>

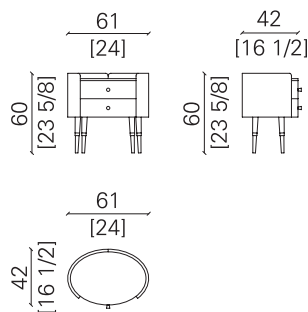

Comodino con struttura in multistrato di pioppo curvato rivestito in pergamena color rubino in finitura lucida. Piano in onice Rosa Extra. Fondo cassetti rivestiti in pelle in tinta. Pomoli e puntali in ottone in finitura bagno oro lucido.

Bedside table with a curved multi-ply poplar structure, clad in ruby coloured parchment, with glossy finish. Top in Pink Extra onyx. Drawer bottoms lined in matching leather. Knobs and tips in brass with shiny gold plated finish.

#### finiture | finishes

piano in onice  
top in onyx

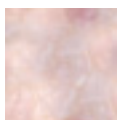

**OX03**  
onice Rosa  
Extra  
Pink Extra  
onyx

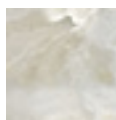

**OX04**  
onice White  
Extra  
White Extra  
onyx

A. finitura in pergamena lucida  
glossy parchment finish



**PES01.G**  
pergamena  
lucida rubino  
glossy  
parchment  
ruby colour



**PE04.G**  
pergamena  
lucida naturale  
glossy  
parchment  
natural colour

+ altri colori  
+ other colours

B. finitura in laccato lucido  
glossy lacquered finish

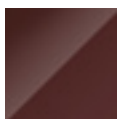

**LAS02.G**  
laccato lucido  
col. rubino  
glossy  
lacquered  
ruby colour



**LA06.G**  
laccato lucido  
col. avorio  
glossy  
lacquered  
ivory colour

+ altri colori  
+ other colours

Altre finiture disponibili su richiesta. | Other finishes available upon request.

## LE GINESTRE

### COMODINO VARIANTE 1 | BEDSIDE TABLE VARIANT 1

quantità | quantity    prezzo | price

#### finiture | finishes

fondo cassetti in pelle  
drawer bottoms in leather

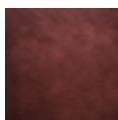

**ET5060**  
pelle  
leather



**ET5002**  
pelle  
leather

+ altri colori  
+ other colours

0,3 mq

pomoli e puntali in ottone  
knobs and tips in brass



**ME01**  
bronzato  
bronzed



**ME02**  
bagno oro  
lucido  
shiny gold  
plated



**ME03**  
satinato  
satin finish



**ME04**  
cromo nero  
lucido  
shiny black  
chrome

#### composizioni | compositions

**A.** Comodino in finitura pergamena lucida.  
Bedside table with glossy parchment finish.

€ 14.740,00

**B.** Comodino in finitura laccato lucido.  
Bedside table with glossy lacquered finish.

€ 12.100,00

Altre finiture disponibili su richiesta. | Other finishes available upon request.

## LE GINESTRE

### COMODINO VARIANTE 2 | BEDSIDE TABLE VARIANT 2





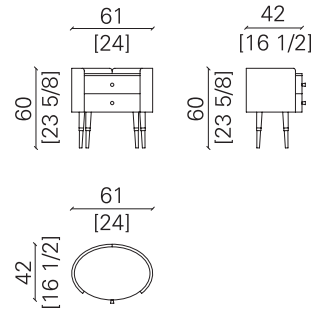

by Fabio Crippa & Joe Gentile

dimensioni   dimensions	L61 x P42 x H60 cm
peso   weight	62 kg
volume   volume	0,26 m <sup>3</sup>



Comodino con struttura in multistrato di pioppo curvato impiallacciato in noce americano naturale in finitura opaca. Piano in noce americano naturale in finitura opaca. Fondo cassetti rivestiti in pelle in tinta. Pomoli e puntali in ottone in finitura satinata.

Bedside table with curved multi-ply poplar structure, veneered in matt finished natural American walnut. Top in matt finished natural American walnut. Drawer bottoms lined in matching leather. Knobs and tips in brass with satin finish.

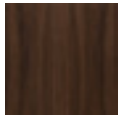
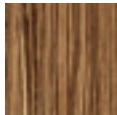
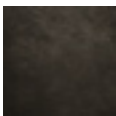
finiture   finishes					quantità   quantity
<b>A.</b> finitura in essenza di legno lucida lucida glossy wood finish	 <b>PL01.G</b> palissandro scuro lucido glossy dark rosewood	 <b>NA01.G</b> noce amer. scuro lucido glossy dark American walnut	 <b>NA02.G</b> noce amer. naturale lucido glossy natural American walnut	 <b>ZB01.G</b> zebrano lucido glossy zebrawood	
<b>B.</b> finitura in essenza di legno opaca opaca matt wood finish	 <b>PL01.M</b> palissandro scuro opaco matt dark rosewood	 <b>NA01.M</b> noce amer. scuro opaco matt dark American walnut	 <b>NA02.L.M</b> noce amer. naturale opaco matt natural American walnut	 <b>ZB01.M</b> zebrano opaco matt zebrawood	
fondo cassetti in pelle drawer bottoms in leather	 <b>ET5085</b> pelle leather	+ altri colori + other colours			<b>2 mq</b>

Altre finiture disponibili su richiesta. | Other finishes available upon request.

## LE GINESTRE

COMODINO VARIANTE 2 | BEDSIDE TABLE VARIANT 2

prezzo | price

### finiture | finishes

pomoli e puntali in ottone  
knobs and tips in brass



**ME01**  
bronzato  
bronzed



**ME02**  
bagno oro  
lucido  
shiny gold  
plated



**ME03**  
satinato  
satin finish



**ME04**  
cromo nero  
lucido  
shiny black  
chrome

### composizioni | compositions

**A.** Comodino in finitura essenza di legno a scelta lucida.  
Bedside table with choice of glossy wood finishes.

€ 11.490,00

**B.** Comodino in finitura essenza di legno a scelta opaca.  
Bedside table with choice of matt wood finishes.

€ 10.980,00

Altre finiture disponibili su richiesta. | Other finishes available upon request.

## LE GINESTRE

### TOELETTA VARIANTE 1 | DRESSING TABLE VARIANT 1

by Fabio Crippa & Joe Gentile

dimensioni | dimensions L104 x P52 x H118 cm  
 peso | weight 78 kg  
 volume | volume 0,90 m<sup>3</sup>

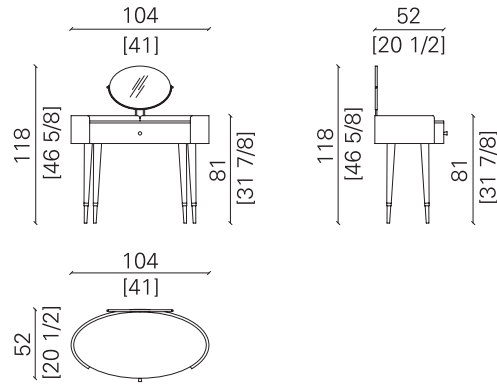

Toeletta con struttura in multistrato di pioppo curvato rivestito in pergamena color rubino in finitura lucida. Specchio girevole ovale con cornice in ottone in finitura bagno oro lucido. Piano in onice Rosa Extra. Fondo cassetti rivestiti in pelle in tinta. Pomoli e puntali in ottone in finitura bagno oro lucido.

Dressing table with a curved multi-ply poplar structure clad in ruby coloured parchment, with glossy finish. Oval swivel mirror with shiny gold plated brass frame. Top in Pink Extra onyx. Drawer bottoms lined in matching leather. Knobs and tips in brass with shiny gold plated finish.

#### finiture | finishes

piano in onice  
top in onyx

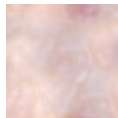

**OX03**  
onice Rosa Extra  
Pink Extra onyx



**OX04**  
onice White Extra  
White Extra onyx

A. finitura in pergamena lucida  
glossy parchment finish



**PES01.G**  
pergamena lucida rubino  
glossy parchment ruby colour



**PE04.G**  
pergamena lucida naturale  
glossy parchment natural colour

+ altri colori  
+ other colours

B. finitura in laccato lucido  
glossy lacquered finish

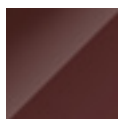

**LAS02.G**  
laccato lucido col. rubino  
glossy lacquered ruby colour



**LA06.G**  
laccato lucido col. avorio  
glossy lacquered ivory colour

+ altri colori  
+ other colours

Altre finiture disponibili su richiesta. | Other finishes available upon request.

## LE GINESTRE

### TOELETTA VARIANTE 1 | DRESSING TABLE VARIANT 1

quantità | quantity    prezzo | price

#### finiture | finishes

fondo cassetti in pelle  
drawer bottoms in leather

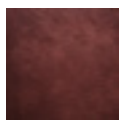

**ET5060**  
pelle  
leather



**ET5002**  
pelle  
leather

+ altri colori  
+ other colours

0,3 mq

specchio  
mirror



**SP01**  
specchio naturale  
natural mirror

cornice specchio, pomoli e  
puntali in ottone  
mirror frame, knobs and tips  
in brass



**ME01**  
bronzato  
bronzed



**ME02**  
bagno oro  
lucido  
shiny gold  
plated



**ME03**  
satinato  
satin finish



**ME04**  
cromo nero  
lucido  
shiny black  
chrome

#### composizioni | compositions

- A.** Toeletta in finitura pergamena lucida.  
Dressing table with glossy parchment finish.
- B.** Toeletta in finitura laccato lucido.  
Dressing table with glossy lacquered finish.

€ 17.740,00

€ 15.420,00

Altre finiture disponibili su richiesta. | Other finishes available upon request.

# LE GINESTRE

## TOILETTA VARIANTE 2 | DRESSING TABLE VARIANT 2

by Fabio Crippa & Joe Gentile

dimensioni | dimensions L104 x P52 x H118 cm  
 peso | weight 78 kg  
 volume | volume 0,90 m<sup>3</sup>

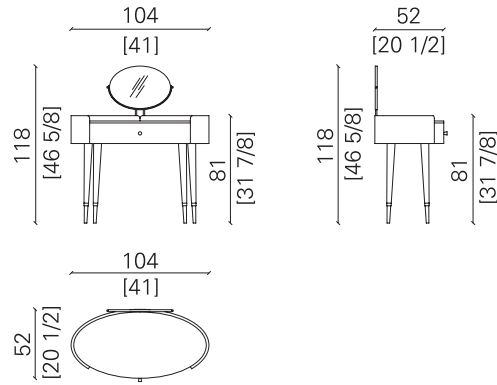

Toeletta con struttura in multistrato di pioppo curvato impiallacciato in noce americano naturale in finitura opaca. Specchio girevole ovale con cornice in ottone in finitura satinata. Piano in noce americano naturale in finitura opaca. Fondo cassetti rivestiti in pelle in tinta. Maniglie e puntali in ottone in finitura satinata.

Dressing table with curved multi-ply poplar structure, veneered in matt finished natural American walnut. Oval swivel mirror with brass frame in satin finish. Top in matt finished natural American walnut. Drawer bottoms lined in matching leather. Knobs and tips in brass with satin finish.

finiture   finishes		quantità   quantity				
<b>A.</b> finitura in essenza di legno lucida glossy wood finish						
	<b>PL01.G</b> palissandro scuro lucido glossy dark rosewood	<b>NA01.G</b> noce amer. scuro lucido glossy dark American walnut	<b>NA02.G</b> noce amer. naturale lucido glossy natural American walnut		<b>ZB01.G</b> zebrano lucido glossy zebrawood	
	<b>B.</b> finitura in essenza di legno opaca matt wood finish					
		<b>PL01.M</b> palissandro scuro opaco matt dark rosewood	<b>NA01.M</b> noce amer. scuro opaco matt dark American walnut		<b>NA02.L.M</b> noce amer. naturale opaco matt natural American walnut	
fondo cassetti in pelle drawer bottoms in leather	 <b>ET5085</b> pelle leather	+ altri colori + other colours		0,3 mq		

Altre finiture disponibili su richiesta. | Other finishes available upon request.



## LE GINESTRE

### TOILETTA VARIANTE 2 | DRESSING TABLE VARIANT 2

prezzo | price

#### finiture | finishes

specchio  
mirror



**SP01**  
specchio naturale  
natural mirror

cornice specchio, pomoli e  
puntali in ottone  
mirror frame, knobs and tips  
in brass



**ME01**  
bronzato  
bronzed



**ME02**  
bagno oro  
lucido  
shiny gold  
plated



**ME03**  
satinato  
satin finish



**ME04**  
cromo nero  
lucido  
shiny black  
chrome

#### composizioni | compositions

**A.** Toiletta in finitura essenza di legno lucida.  
Dressing table with glossy wood finish.

€ 13.620,00

**B.** Toiletta in finitura essenza di legno opaca.  
Dressing table with matt wood finish.

€ 12.570,00

Altre finiture disponibili su richiesta. | Other finishes available upon request.

## LE GINESTRE

### POUF GRANDE | POUF LARGE



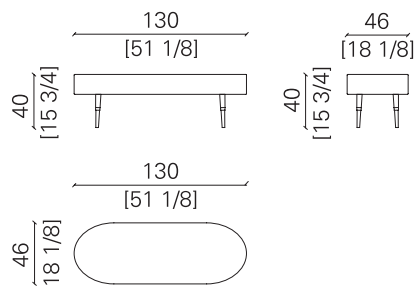

by Fabio Crippa & Joe Gentile

dimensioni   dimensions	L130 x P46 x H40 cm
peso   weight	22 kg
volume   volume	0,40 m <sup>3</sup>

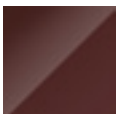

Pouf imbottito in velluto con profilo in tinta. Gambe rivestite in pergamena color rubino in finitura lucida. Puntali in ottone in finitura bagno oro lucido.

Pouf upholstered in velvet with matching profile. Legs clad in ruby coloured parchment, with glossy finish. Tips in brass with shiny gold plated finish.

finiture   finishes		quantità   quantity
imbottitura in velluto velvet upholstery	 <p>+ altri colori + other colours</p> <p><b>JBBL060</b> velluto velvet</p>	<b>2 ml</b>
A. finitura gambe in pergamena lucida legs finished in glossy parchment	 <p><b>PES01.G</b> pergamena lucida rubino glossy parchment ruby colour</p>  <p>+ altri colori + other colours</p> <p><b>PE04.G</b> pergamena lucida naturale glossy parchment natural colour</p>	
B. finitura gambe in laccato lucido legs with glossy lacquered finish	 <p><b>LAS02.G</b> laccato lucido col. rubino glossy lacquered ruby colour</p>  <p>+ altri colori + other colours</p> <p><b>LA06.G</b> laccato lucido col. avorio glossy lacquered ivory colour</p>	

Altre finiture disponibili su richiesta. | Other finishes available upon request.

## LE GINESTRE

### POUF GRANDE | POUF LARGE

prezzo | price

#### finiture | finishes

**C.** finitura gambe in essenza di legno lucida  
legs with glossy wood finish



**PL01.G**  
palissandro  
scuro lucido  
glossy dark  
rosewood

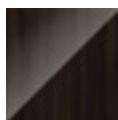

**NA01.G**  
noce amer.  
scuro lucido  
glossy dark  
American  
walnut



**NA02.G**  
noce amer.  
naturale lucido  
glossy natural  
American  
walnut



**ZB01.G**  
zebrano lucido  
glossy  
zebrawood

**D.** finitura gambe in essenza di legno opaca  
legs with matt wood finish



**PL01.M**  
palissandro  
scuro opaco  
matt dark  
rosewood



**NA01.M**  
noce amer.  
scuro opaco  
matt dark  
American  
walnut



**NA02.L.M**  
noce amer.  
naturale opaco  
matt natural  
American  
walnut

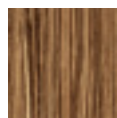

**ZB01.M**  
zebrano opaco  
matt  
zebrawood

puntali in ottone  
tips in brass



**ME01**  
bronzato  
bronzed



**ME02**  
bagno oro  
lucido  
shiny gold  
plated



**ME03**  
satinato  
satin finish



**ME04**  
cromo nero  
lucido  
shiny black  
chrome

#### composizioni | compositions

- |   |                   |
|---|-------------------|
| <b>A.</b> Pouf con gambe in finitura pergamena lucida.<br>Pouf with glossy parchment finished legs.                           | <b>€ 2.540,00</b> |
| <b>B.</b> Pouf con gambe in finitura laccato lucido.<br>Pouf with glossy lacquered finished legs.                             | <b>€ 2.470,00</b> |
| <b>C.</b> Pouf con gambe in finitura essenza di legno a scelta lucida.<br>Pouf with legs in a choice of glossy wood finishes. | <b>€ 2.510,00</b> |
| <b>D.</b> Pouf con gambe in finitura essenza di legno a scelta opaca.<br>Pouf with legs in a choice of matt wood finishes.    | <b>€ 2.400,00</b> |

Altre finiture disponibili su richiesta. | Other finishes available upon request.

## LE GINESTRE

### POUF PICCOLO | POUF SMALL



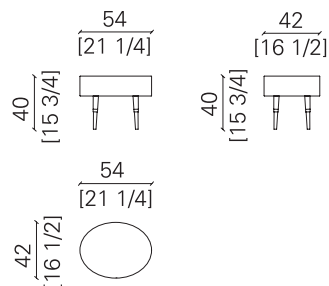

by Fabio Crippa & Joe Gentile

dimensioni   dimensions	L54 x P42 x H40 cm
peso   weight	12 kg
volume   volume	0,16 m <sup>3</sup>

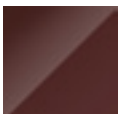

Pouf imbottito in velluto con profilo in tinta. Gambe rivestite in pergamena color rubino in finitura lucida. Puntali in ottone in finitura bagno oro lucido.

Pouf upholstered in velvet with matching profile. Legs clad in ruby coloured parchment, with glossy finish. Tips in brass with shiny gold plated finish.

finiture   finishes		quantità   quantity
imbottitura in velluto velvet upholstery	 <p>+ altri colori + other colours</p> <p><b>JBBL060</b> velluto velvet</p>	<b>1 ml</b>
A. finitura gambe in pergamena lucida legs finished in glossy parchment	 <p><b>PES01.G</b> pergamena lucida rubino glossy parchment ruby colour</p>  <p>+ altri colori + other colours</p> <p><b>PE04.G</b> pergamena lucida naturale glossy parchment natural colour</p>	
B. finitura gambe in laccato lucido legs with glossy lacquered finish	 <p><b>LAS02.G</b> laccato lucido col. rubino glossy lacquered ruby colour</p>  <p>+ altri colori + other colours</p> <p><b>LA06.G</b> laccato lucido col. avorio glossy lacquered ivory colour</p>	

Altre finiture disponibili su richiesta. | Other finishes available upon request.

## LE GINESTRE

### POUF PICCOLO | POUF SMALL

prezzo | price

#### finiture | finishes

**C.** finitura gambe in essenza di legno lucida  
legs with glossy wood finish



**PL01.G**  
palissandro  
scuro lucido  
glossy dark  
rosewood

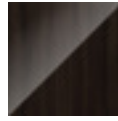

**NA01.G**  
noce amer.  
scuro lucido  
glossy dark  
American  
walnut



**NA02.G**  
noce amer.  
naturale lucido  
glossy natural  
American  
walnut

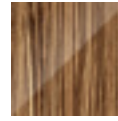

**ZB01.G**  
zebrano lucido  
glossy  
zebrawood

**D.** finitura gambe in essenza di legno opaca  
legs with matt wood finish



**PL01.M**  
palissandro  
scuro opaco  
matt dark  
rosewood



**NA01.M**  
noce amer.  
scuro opaco  
matt dark  
American  
walnut



**NA02.L.M**  
noce amer.  
naturale opaco  
matt natural  
American  
walnut

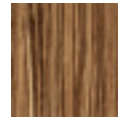

**ZB01.M**  
zebrano opaco  
matt  
zebrawood

puntali in ottone  
tips in brass



**ME01**  
bronzato  
bronzed



**ME02**  
bagno oro  
lucido  
shiny gold  
plated



**ME03**  
satinato  
satin finish



**ME04**  
cromo nero  
lucido  
shiny black  
chrome

#### composizioni | compositions

- |   |                   |
|---|-------------------|
| <b>A.</b> Pouf con gambe in finitura pergamena lucida.<br>Pouf with glossy parchment finished legs.                           | <b>€ 1.930,00</b> |
| <b>B.</b> Pouf con gambe in finitura laccato lucido.<br>Pouf with glossy lacquered finished legs.                             | <b>€ 1.860,00</b> |
| <b>C.</b> Pouf con gambe in finitura essenza di legno a scelta lucida.<br>Pouf with legs in a choice of glossy wood finishes. | <b>€ 1.890,00</b> |
| <b>D.</b> Pouf con gambe in finitura essenza di legno a scelta opaca.<br>Pouf with legs in a choice of matt wood finishes.    | <b>€ 1.790,00</b> |

Altre finiture disponibili su richiesta. | Other finishes available upon request.

# IL CIRMOLO

## LETTO | BED

by Fabio Crippa & Joe Gentile

dimensioni   dimensions	L227 x P218 x H147 cm
peso   weight	138 kg
volume letto   bed volume	2,40 m <sup>3</sup>
volume testata   headboard volume	0,90 m <sup>3</sup>

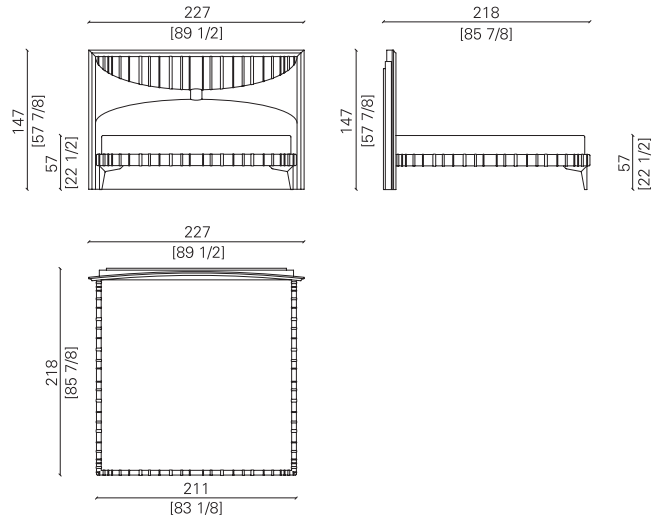

Letto con struttura in multistrato di pioppo curvato impiallacciato in noce americano e cornici in massello di noce americano tinto scuro lucido. Testata e giroletto imbottiti in pelle con cucitura decorativa in tinta. Dettagli in ottone in finitura satinata. Retroilluminazione a LED. Compreso di rete ortopedica. Escluso materasso e set biancheria letto.

Bed with curved multi-ply poplar structure, veneered in American walnut, with dark glossy coloured solid American walnut frames. Headboard and bedframe in leather with matching decorative stitching. Details in brass with satin finish. LED backlighting. Including orthopedic bedspring. Excluding mattress and bed linen.

### finiture | finishes

#### A. finitura in essenza di legno lucida glossy wood finish



**PL01.G**  
palissandro scuro lucido  
glossy dark rosewood

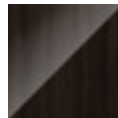

**NA01.G**  
noce amer. scuro lucido  
glossy dark American walnut



**NA02.G**  
noce amer. naturale lucido  
glossy natural American walnut

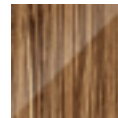

**ZB01.G**  
zebrano lucido  
glossy zebra wood

#### B. finitura in essenza di legno opaca matt wood finish



**PL01.M**  
palissandro scuro opaco  
matt dark rosewood



**NA01.M**  
noce amer. scuro opaco  
matt dark American walnut



**NA02.L.M**  
noce amer. naturale opaco  
matt natural American walnut

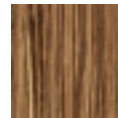

**ZB01.M**  
zebrano opaco  
matt zebra wood

#### C. finitura in laccato lucido glossy lacquered finish



**LA.05L**  
laccato lucido col. testa di moro  
glossy lacquered brown colour

+ altri colori  
+ other colours

Altre finiture disponibili su richiesta. | Other finishes available upon request.

## IL CIRMOLO

### LETTO | BED

quantità | quantity    prezzo | price

#### finiture | finishes

imbottitura in pelle con cucitura  
in tinta  
upholstered in leather with  
matching stitching



**ET5002**  
pelle  
leather

+ altri colori  
+ other colours

12 mq

dettagli in ottone  
details in brass



**ME01**  
bronzato  
bronzed



**ME02**  
bagno oro  
lucido  
shiny gold  
plated



**ME03**  
satinato  
satin finish



**ME04**  
cromo nero  
lucido  
shiny black  
chrome

rete ortopedica  
orthopedic bedspring

dimensione rete per materasso 200 x 200 cm  
bedspring for 200 x 200 cm mattress

#### composizioni | compositions

- |  |                    |
|--|--------------------|
| <p><b>A.</b> Letto con struttura in essenza di legno lucida a scelta e rivestimento in pelle.<br/>Bed with structure in a choice of glossy woods and leather upholstery.</p> | <p>€ 18.150,00</p> |
| <p><b>B.</b> Letto con struttura in essenza di legno opaca a scelta e rivestimento in pelle.<br/>Bed with structure in a choice of matt woods and leather upholstery.</p>    | <p>€ 17.620,00</p> |
| <p><b>C.</b> Letto con struttura in finitura laccato lucido e rivestimento in pelle.<br/>Bed with glossy lacquered structure, and leather upholstery.</p>                    | <p>€ 17.340,00</p> |

Altre finiture disponibili su richiesta. | Other finishes available upon request.

## IL CIRMOLO

### LETTO | BED

quantità | quantity    prezzo | price

#### cuscini | cushions

cuscino decorativo A  
50x50 cm x 1pz  
decorative cushion A  
50x50 cm x 1 pc

Imbottitura cuscini in piuma d'oca. Profilo in tinta o in contrasto.  
Ducks' down cushion filling. Matching or contrasting border.

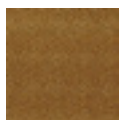

+ altri colori  
+ other colours

0,6 mtl    €    270,00

**RUSM004**  
velluto  
velvet

cuscino decorativo B  
40x40 cm x 1pz  
decorative cushion B  
40x40 cm x 1 pc

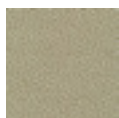

+ altri colori  
+ other colours

0,5 mtl    €    140,00

**RUCS002**  
tessuto  
fabric

cuscino a rullo  
Ø18x60 cm x 1pz  
roll cushion  
Ø18x60 cm x 1 pc

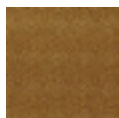

+ altri colori  
+ other colours

1 mtl    €    380,00

**RUSM004**  
velluto  
velvet

Altre finiture disponibili su richiesta. | Other finishes available upon request.



## IL CIRMOLO

### LETTO | BED

quantità | quantity    prezzo | price

set biancheria | set of linen

Set biancheria letto bicolore in raso di cotone 100%. Compreso di:  
 n. 2 guanciali con n. 2 federe con bordo a volano in contrasto  
 n. 1 lenzuolo con angolo  
 n. 1 lenzuolo con bordo a volano in contrasto  
 n. 1 piumino con n. 1 copripiumino bicolore

Two-tone set of bed linen in 100% cotton satin. Including:  
 n. 2 pillows with n° 2 pillowcases, with contrasting frilly border  
 n. 1 fitted sheet  
 n. 1 flat sheet with contrasting frilly border  
 n. 1 duvet with n. 1 two-tone duvet cover

set biancheria letto  
 bed linen set



+ altri colori  
 + other colours

beige chiaro con profilo beige più scuro  
 light beige with darker beige border

€ 1.130,00

materasso | mattress

materasso  
 mattress

Materasso ortopedico.  
 Orthopedic mattress.

su richiesta  
 upon request

## LE TAMERICI

### COMÒ | CHEST OF DRAWERS

by Fabio Crippa & Joe Gentile

dimensioni | dimensions L150 x P57 x H94 cm  
 peso | weight 130 kg  
 volume | volume 1,10 m<sup>3</sup>

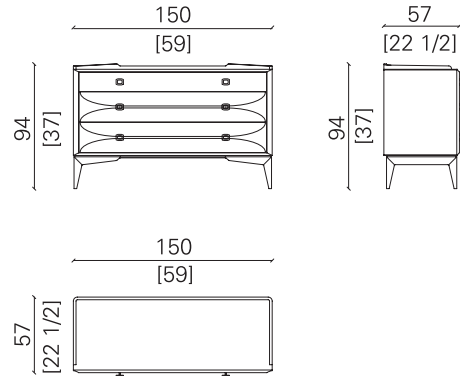

Comò con struttura in multistrato di pioppo e cornici con basamento in massello di noce americano tinto scuro opaco. Rivestimento in pelle con cuciture in tinta e maniglie in ottone in finitura satinata. Fondo cassetti rivestiti in pelle con cucitura in tinta.

Chest of drawers with multi-ply poplar structure and frames with base in solid dark matt American walnut. Leather upholstery with matching stitching, and handles in brass with satin finish. Drawer bottoms lined in leather with matching stitching.

#### finiture | finishes

**A.** finitura in essenza di legno lucida  
 glossy wood finish



**PL01.G**  
 palissandro scuro lucido  
 glossy dark rosewood



**NA01.G**  
 noce amer. scuro lucido  
 glossy dark American walnut



**NA02.G**  
 noce amer. naturale lucido  
 glossy natural American walnut



**ZB01.G**  
 zebrano lucido  
 glossy zebrawood

**B.** finitura in essenza di legno opaca  
 matt wood finish



**PL01.M**  
 palissandro scuro opaco  
 matt dark rosewood



**NA01.M**  
 noce amer. scuro opaco  
 matt dark American walnut



**NA02.L.M**  
 noce amer. naturale opaco  
 matt natural American walnut

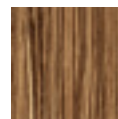

**ZB01.M**  
 zebrano opaco  
 matt zebrawood

**C.** finitura in laccato lucido  
 glossy lacquered finish



**LA.05L**  
 laccato lucido col. testa di moro  
 glossy lacquered brown colour

+ altri colori  
 + other colours

Altre finiture disponibili su richiesta. | Other finishes available upon request.

## LE TAMERICI

### COMÒ | CHEST OF DRAWERS

quantità | quantity    prezzo | price

#### finiture | finishes

rivestimento in pelle con cuciture in tinta  
upholstered in leather with matching stitching



+ altri colori  
+ other colours

**ET5002**  
pelle  
leather

14 mq

fondo cassetti in pelle con cuciture in tinta  
drawer bottoms in leather with matching stitching



+ altri colori  
+ other colours

**ET5002**  
pelle  
leather

maniglie in ottone  
brass handles



**ME01**  
bronzato  
bronzed



**ME02**  
bagno oro  
lucido  
shiny gold  
plated



**ME03**  
satinato  
satin finish



**ME04**  
cromo nero  
lucido  
shiny black  
chrome

#### composizioni | compositions

**A.** Comò con struttura in essenza di legno lucida a scelta e rivestimento in pelle.  
Chest of drawers with structure in a choice of glossy woods and leather upholstery.

€ 11.920,00

**B.** Comò con struttura in essenza di legno opaca a scelta e rivestimento in pelle.  
Chest of drawers with structure in a choice of matt woods and leather upholstery.

€ 11.280,00

**C.** Comò con struttura in finitura laccato lucido e rivestimento in pelle.  
Chest of drawers with glossy lacquered structure, and leather upholstery.

€ 11.280,00

Altre finiture disponibili su richiesta. | Other finishes available upon request.

## LE TAMERICI

### COMODINO | BEDSIDE TABLE

by Fabio Crippa & Joe Gentile

dimensioni   dimensions	L60 x P42 x H62 cm
peso   weight	60 kg
volume   volume	0,26 m <sup>3</sup>

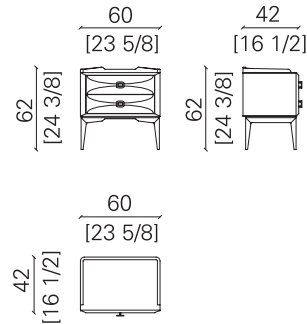

Comodino con struttura in multistrato di pioppo e cornici con basamento in massello di noce americano tinto scuro opaco. Rivestimento in pelle con cuciture in tinta e maniglie in ottone in finitura satinata. Fondo cassetti in pelle con cucitura in tinta.

Bedside table with multi-ply poplar structure and frames with base in solid dark matt American walnut. Leather upholstery with matching stitching, and handles in brass with satin finish. Drawer bottoms in leather with matching stitching.

#### finiture | finishes

#### A. finitura in essenza di legno lucida glossy wood finish



**PL01.G**  
palissandro scuro lucido  
glossy dark rosewood



**NA01.G**  
noce amer. scuro lucido  
glossy dark American walnut



**NA02.G**  
noce amer. naturale lucido  
glossy natural American walnut



**ZB01.G**  
zebrano lucido  
glossy zebrawood

#### B. finitura in essenza di legno opaca matt wood finish



**PL01.M**  
palissandro scuro opaco  
matt dark rosewood



**NA01.M**  
noce amer. scuro opaco  
matt dark American walnut



**NA02.L.M**  
noce amer. naturale opaco  
matt natural American walnut

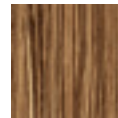

**ZB01.M**  
zebrano opaco  
matt zebrawood

#### C. finitura in laccato lucido glossy lacquered finish



**LA.05L**  
laccato lucido col. testa di moro  
glossy lacquered brown colour

+ altri colori  
+ other colours

Altre finiture disponibili su richiesta. | Other finishes available upon request.

## LE TAMERICI

### COMODINO | BEDSIDE TABLE

quantità | quantity    prezzo | price

#### finiture | finishes

rivestimento in pelle con cuciture in tinta  
upholstered in leather with matching stitching

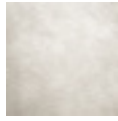

+ altri colori  
+ other colours

4,5 mq

**ET5002**  
pelle  
leather

fondo cassetti in pelle con cuciture in tinta  
drawer bottoms in leather with matching stitching



+ altri colori  
+ other colours

**ET5002**  
pelle  
leather

maniglie in ottone  
brass handles



**ME01**  
bronzato  
bronzed



**ME02**  
bagno oro  
lucido  
shiny gold  
plated



**ME03**  
satinato  
satin finish



**ME04**  
cromo nero  
lucido  
shiny black  
chrome

#### composizioni | compositions

- |   |                          |
|---|--------------------------|
| <p><b>A.</b> Comodino con struttura in essenza di legno lucida a scelta e rivestimento in pelle.<br/>Bedside table with structure in a choice of glossy woods and leather upholstery.</p> | <p>€ <b>5.140,00</b></p> |
| <p><b>B.</b> Comodino con struttura in essenza di legno opaca a scelta e rivestimento in pelle.<br/>Bedside table with structure in a choice of matt woods and leather upholstery.</p>    | <p>€ <b>5.010,00</b></p> |
| <p><b>C.</b> Comodino con struttura in finitura laccato lucido e rivestimento in pelle.<br/>Bedside table with glossy lacquered structure, and leather upholstery.</p>                    | <p>€ <b>4.660,00</b></p> |

Altre finiture disponibili su richiesta. | Other finishes available upon request.

## LE TAMERICI

### TOELETTA | DRESSING TABLE

by Fabio Crippa & Joe Gentile

dimensioni | dimensions L120 x P57 x H125 cm  
 peso | weight 70 kg  
 volume | volume 1,18 m<sup>3</sup>

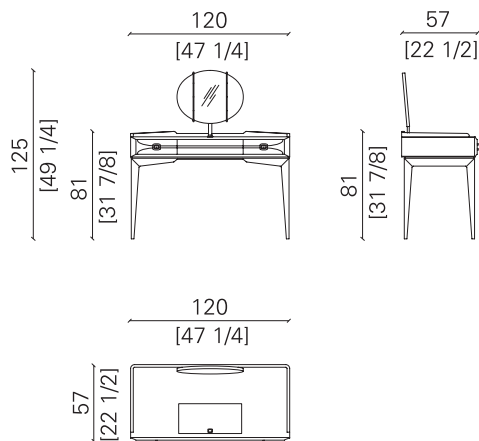

Toeletta con struttura in multistrato di pioppo impiallacciato in noce americano, basamento e cornici in massello di noce americano tinto scuro opaco. Rivestimento in pelle con cuciture in tinta. Due cassetti con profili massellati e frontali impiallacciati in noce americano con fondo in pelle con cuciture in tinta e maniglie in ottone in finitura satinata. Specchio ovale pieghevole con cornice rivestita in pelle. Top con anta a ribalta rivestita in pelle con cucitura in tinta e maniglia in ottone in finitura satinata con porta oggetti all'interno.

Dressing table with multi-ply poplar structure veneered in American walnut, base and frames in solid dark matt American walnut. Leather upholstery with matching stitching. Two drawers with solid profiles and fronts veneered in American walnut with bottoms in leather with matching stitching and handles in brass with satin finish. Folding oval mirror with leather upholstered frame. Top with flap door covered in leather with matching stitching and handle in brass with satin finish with storage compartment inside.

#### finiture | finishes

**A.** finitura in essenza di legno lucida  
 glossy wood finish



**PL01.G**  
 palissandro scuro lucido  
 glossy dark rosewood

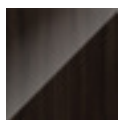

**NA01.G**  
 noce amer. scuro lucido  
 glossy dark American walnut



**NA02.G**  
 noce amer. naturale lucido  
 glossy natural American walnut



**ZB01.G**  
 zebrano lucido  
 glossy zebra wood

**B.** finitura in essenza di legno opaca  
 matt wood finish



**PL01.M**  
 palissandro scuro opaco  
 matt dark rosewood



**NA01.M**  
 noce amer. scuro opaco  
 matt dark American walnut



**NA02.L.M**  
 noce amer. naturale opaco  
 matt natural American walnut

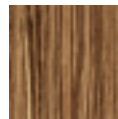

**ZB01.M**  
 zebrano opaco  
 matt zebra wood

**C.** finitura in laccato lucido  
 glossy lacquered finish



**LA.05L**  
 laccato lucido col. testa di moro  
 glossy lacquered brown colour

+ altri colori  
 + other colours

Altre finiture disponibili su richiesta. | Other finishes available upon request.

## LE TAMERICI

### TOELETTA | DRESSING TABLE

quantità | quantity    prezzo | price

#### finiture | finishes

specchio  
mirror



**SP01**  
specchio naturale  
natural mirror

rivestimento in pelle con  
cuciture in tinta  
upholstered in leather with  
matching stitching



+ altri colori  
+ other colours

**ET5002**  
pelle  
leather

4,5 mq

fondo cassetti in pelle con  
cuciture in tinta  
drawer bottoms in leather with  
matching stitching



+ altri colori  
+ other colours

**ET5002**  
pelle  
leather

maniglie in ottone  
brass handles



**ME01**  
bronzato  
bronzed



**ME02**  
bagno oro  
lucido  
shiny gold  
plated



**ME03**  
satinato  
satin finish



**ME04**  
cromo nero  
lucido  
shiny black  
chrome

#### composizioni | compositions

- A.** Toeletta con struttura in essenza di legno a scelta lucida e rivestimento in pelle.  
Dressing table with structure in a choice of glossy woods and leather upholstery. **€ 9.760,00**
- B.** Toeletta con struttura in essenza di legno a scelta opaca e rivestimento in pelle.  
Dressing table with structure in a choice of matt woods and leather upholstery. **€ 9.410,00**
- C.** Toeletta con struttura in finitura laccato lucido e rivestimento in pelle.  
Dressing table with glossy lacquered structure, and leather upholstery. **€ 9.150,00**

Altre finiture disponibili su richiesta. | Other finishes available upon request.

## LE TAMERICI

### SCRITTOIO | WRITING DESK

by Fabio Crippa & Joe Gentile

dimensioni | dimensions L120 x P57 x H81 cm  
 peso | weight 70 kg  
 volume | volume 0,80 m<sup>3</sup>

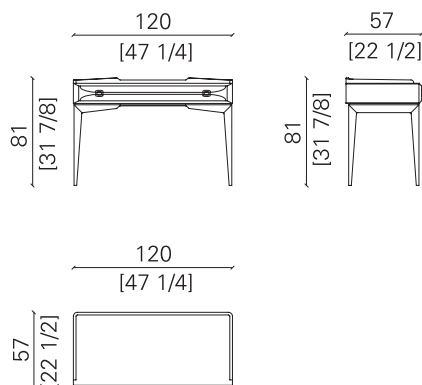

Scrivania con struttura in multistrato di pioppo impiallacciato in noce americano, basamento e cornici in massello di noce americano tinto scuro opaco. Rivestimento in pelle con cuciture in tinta. Cassetto con profili massellati e frontale impiallacciato in noce americano con fondo in pelle con cuciture in tinta e maniglie in ottone in finitura satinata.

Writing desk with multi-ply poplar structure, veneered in American walnut, with dark matt coloured solid American walnut base and frames. Leather upholstery with matching stitching. Drawer with solid profiles and front veneered in American walnut, bottom in leather with matching stitching and handles in brass with satin finish.

#### finiture | finishes

**A.** finitura in essenza di legno lucida  
 glossy wood finish



**PL01.G**  
 palissandro scuro lucido  
 glossy dark rosewood



**NA01.G**  
 noce amer. scuro lucido  
 glossy dark American walnut



**NA02.G**  
 noce amer. naturale lucido  
 glossy natural American walnut



**ZB01.G**  
 zebrano lucido  
 glossy zebrawood

**B.** finitura in essenza di legno opaca  
 matt wood finish



**PL01.M**  
 palissandro scuro opaco  
 matt dark rosewood



**NA01.M**  
 noce amer. scuro opaco  
 matt dark American walnut



**NA02.L.M**  
 noce amer. naturale opaco  
 matt natural American walnut

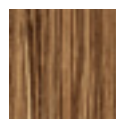

**ZB01.M**  
 zebrano opaco  
 matt zebrawood

**C.** finitura in laccato lucido  
 glossy lacquered finish



**LA.05L**  
 laccato lucido col. testa di moro  
 glossy lacquered brown colour

+ altri colori  
 + other colours

Altre finiture disponibili su richiesta. | Other finishes available upon request.



## LE TAMERICI

### SCRITTOIO | WRITING DESK

quantità | quantity    prezzo | price

#### finiture | finishes

rivestimento in pelle con cuciture in tinta  
upholstered in leather with matching stitching



+ altri colori  
+ other colours

4,5 mq

**ET5002**  
pelle  
leather

fondo cassetti in pelle con cuciture in tinta  
drawer bottoms in leather with matching stitching



+ altri colori  
+ other colours

**ET5002**  
pelle  
leather

maniglie in ottone  
brass handles



**ME01**  
bronzato  
bronzed



**ME02**  
bagno oro  
lucido  
shiny gold  
plated



**ME03**  
satinato  
satin finish



**ME04**  
cromo nero  
lucido  
shiny black  
chrome

#### composizioni | compositions

- |  |                          |
|--|--------------------------|
| <p><b>A.</b> Scrivitoio con struttura in essenza di legno lucida a scelta e rivestimento in pelle.<br/>Writing desk with structure in a choice of glossy woods and leather upholstery.</p> | <p>€ <b>6.930,00</b></p> |
| <p><b>B.</b> Scrivitoio con struttura in essenza di legno opaca a scelta e rivestimento in pelle.<br/>Writing desk with structure in a choice of matt woods and leather upholstery.</p>    | <p>€ <b>6.580,00</b></p> |
| <p><b>C.</b> Scrivitoio con struttura in finitura laccato lucido e rivestimento in pelle.<br/>Writing desk with glossy lacquered finish structure, and leather upholstery.</p>             | <p>€ <b>6.490,00</b></p> |

Altre finiture disponibili su richiesta. | Other finishes available upon request.



**LA SALA DA PRANZO**  
THE DINING ROOM

## IL GELSO

### TAVOLO ROTONDO | ROUND TABLE





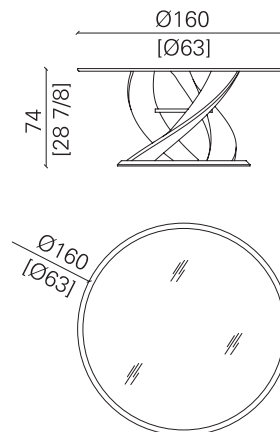



by Fabio Crippa & Joe Gentile

dimensioni | dimensions      Ø160 x H74 cm  
 peso | weight                      335 kg  
 volume | volume                    2,50 m<sup>3</sup>

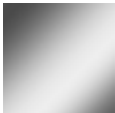

Tavolo rotondo con struttura e cornice in marmo Calacatta Caldia. Piano in cristallo extra-chiaro stratificato e temperato. Anello centrale in ottone in finitura bagno oro lucido.

Round table with Calacatta Caldia marble structure and frame. Top in laminated and tempered glass. Central ring in brass with shiny gold plated finish.

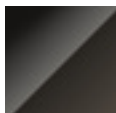
finiture   finishes		prezzo   price		
struttura e cornice structure and top frame	 <b>MA.B04</b> Calacatta Caldia	 <b>MA.N01</b> Nero Marquina		
	piano top	 <b>VE01</b> vetro extrach. extra-clear glass	 <b>VE02</b> vetro bronzato bronzed glass	 <b>VE03</b> vetro fumé smoked glass
anello centrale in ottone central ring in brass		 <b>ME01</b> bronzato bronzed	 <b>ME02</b> oro lucido shiny gold plated	 <b>ME03</b> satinato satin finish
		 <b>ME04</b> cromo nero lucido shiny black chrome		
	<b>A.</b> Tavolo in marmo Calacatta Caldia. Table in Calacatta Caldia marble.		<b>€ 49.000,00</b>	
	<b>B.</b> Tavolo in marmo Nero Marquina. Table in Nero Marquina marble.		<b>€ 43.200,00</b>	

Altre finiture disponibili su richiesta. | Other finishes available upon request.

# LA ROBINIA

## TAVOLO ROTONDO VARIANTE 1 | ROUND TABLE VARIANT 1



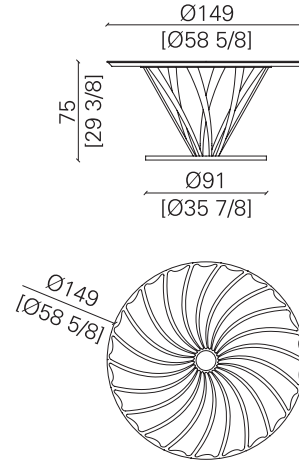

by Fabio Crippa & Joe Gentile

dimensioni | dimensions      Ø149 x H75 cm  
 peso | weight                      160 kg  
 volume | volume                    2,20 m<sup>3</sup>

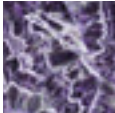

Tavolo rotondo con struttura, inserto piano a spicchi e profilo basamento in ottone in finitura bagno oro lucido. Sottopiano strutturale in mdf laccato lucido con inserti alternati in pietra semipreziosa Ametista e marmo Bianco Lasa. Basamento con inserti in marmo Bianco Lasa.

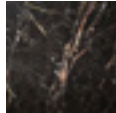
Round table with structure, top insert segments, and base edging in brass, with shiny gold plated finish. Structural undertop in glossy lacquered mdf with alternating semi-precious Amethyst and Bianco Lasa marble inserts. Base with Bianco Lasa marble inserts.

finiture   finishes	A pietra semipreziosa semi-precious stone	B marmo marble	prezzo   price
inserti piano top inserts	 <p><b>PS03</b> Ametista Amethyst</p>  <p><b>PS01</b> Labradorite</p>	 <p><b>MA.B2</b> Bianco Lasa</p>  <p><b>MA.N02</b> Noir Saint Laurent</p>	
inserti basamento in marmo base inserts in marble	 <p><b>MA.B2</b> Bianco Lasa</p>		
piano e struttura in ottone brass top and structure	 <p><b>ME02</b> bagno oro lucido shiny gold plated</p>		
composizioni   compositions	<p><b>A.</b> Tavolo con inserti alternati in pietra semipreziosa e marmo. Table with alternating semi-precious stone and marble inserts.</p> <p><b>B.</b> Tavolo con inserti in marmo. Table with marble inserts.</p>		<p>€ 49.820,00</p> <p>€ 37.810,00</p>

Altre finiture disponibili su richiesta. | Other finishes available upon request.

## LA ROBINIA

### TAVOLO ROTONDO VARIANTE 2 | ROUND TABLE VARIANT 2



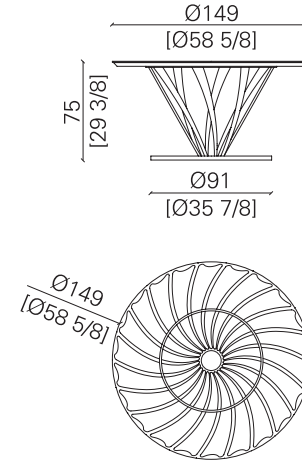

by Fabio Crippa & Joe Gentile

dimensioni | dimensions      Ø149 x H75 cm  
 peso | weight                      180 kg  
 volume | volume                    2,20 m<sup>3</sup>

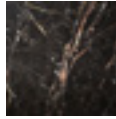

Tavolo rotondo con struttura, inserto piano a spicchi e profilo basamento in ottone in finitura bagno oro lucido. Sottopiano strutturale in mdf laccato lucido con inserti alternati in pietra semipreziosa Ametista e marmo Bianco Lasa. Piano centrale girevole con inserto in pietra semipreziosa Ametista e marmo Bianco Lasa. Basamento con inserti in marmo Bianco Lasa.

Round table with structure, top insert segments, and base edging in brass, with shiny gold plated finish. Structural undertop in glossy lacquered mdf with alternating semi-precious Amethyst and Bianco Lasa marble inserts. Lazy Susan in the centre with semi-precious Amethyst and Bianco Lasa marble inserts. Base with Bianco Lasa marble inserts.

finiture   finishes		A pietra semipreziosa semi-precious stone		B marmo marble		prezzo   price
inserti piano top inserts						
	<b>PS03</b> Ametista Amethyst	<b>PS01</b> Labradorite	<b>MA.B2</b> Bianco Lasa	<b>MA.N02</b> Noir Saint Laurent		
	inserti basamento in marmo base inserts in marble					
	<b>MA.B2</b> Bianco Lasa					
piano e struttura in ottone brass top and structure						
	<b>ME02</b> bagno oro lucido shiny gold plated					
composizioni   compositions		<b>A.</b> Tavolo con inserti alternati in pietra semipreziosa e marmo. Table with alternating semi-precious stone and marble inserts.				<b>€ 53.280,00</b>
		<b>B.</b> Tavolo con inserti in marmo. Table with marble inserts.				<b>€ 40.590,00</b>

Altre finiture disponibili su richiesta. | Other finishes available upon request.

# IL PLATANO

## TAVOLO OVALE VARIANTE 1 | OVAL TABLE VARIANT 1

by Vito Lupo

dimensioni | dimensions L300 x P160 x H76 cm  
 peso | weight 515 kg  
 volume | volume 4,50 m<sup>3</sup>

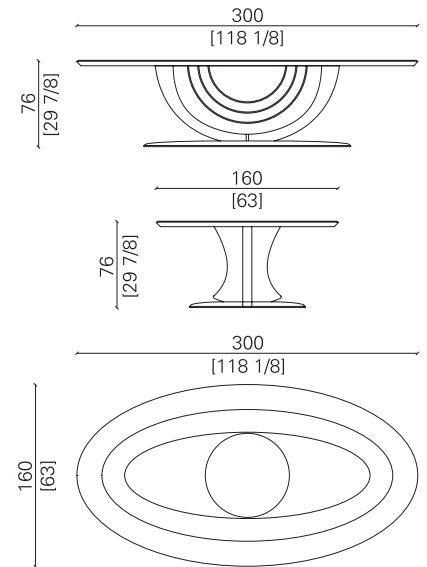

Tavolo ovale con struttura e cornice piano in massello di noce americano tinto scuro opaco e inserto in acero a contrasto. Piano e basamento in marmo Michelangelo. Inserti piano e decorazione basamento in ottone in finitura bagno oro lucido.

Oval table with structure and top edging in dark matt solid American walnut, with contrasting maple wood insert. Top and base in Michelangelo marble. Top inserts and base decoration in brass, with shiny gold plated finish.

### finiture | finishes

piano e basamento in marmo  
 marble top and base

**A**

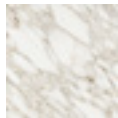

**MA.B01**  
 Calacatta  
 Vagli Oro

**B**

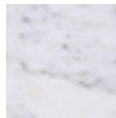

**MA.B03**  
 Michelangelo

struttura in noce americano  
 opaco con inserto in acero  
 a contrasto  
 structure in matt American  
 walnut, with contrasting maple  
 wood insert



**NA01.M**  
 noce amer.  
 scuro opaco  
 matt dark  
 American walnut

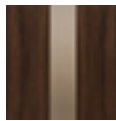

**NA02.M**  
 noce amer.  
 naturale opaco  
 matt natural  
 American walnut

inserti piano e decorazioni  
 in ottone  
 top inserts and decoration in  
 brass



**ME01**  
 bronzato  
 bronzed



**ME02**  
 oro lucido  
 shiny gold  
 plated



**ME03**  
 satinato  
 satin finish

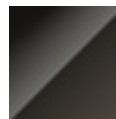

**ME04**  
 cromo nero lucido  
 shiny black chrome

### prezzo | price

### composizioni | compositions

**A.** Tavolo con piano e basamento in marmo Calacatta Vagli Oro.  
 Table with top and base in Calacatta Vagli Oro marble.

€ 52.000,00

**B.** Tavolo con piano e basamento in marmo Michelangelo.  
 Table with top and base in Michelangelo marble.

€ 50.000,00

Altre finiture disponibili su richiesta. | Other finishes available upon request.

# IL PLATANO

## TAVOLO OVALE VARIANTE 2 | OVAL TABLE VARIANT 2

by Vito Lupo

dimensioni | dimensions L300 x P160 x H76 cm  
 peso | weight 365 kg  
 volume | volume 4,50 m<sup>3</sup>

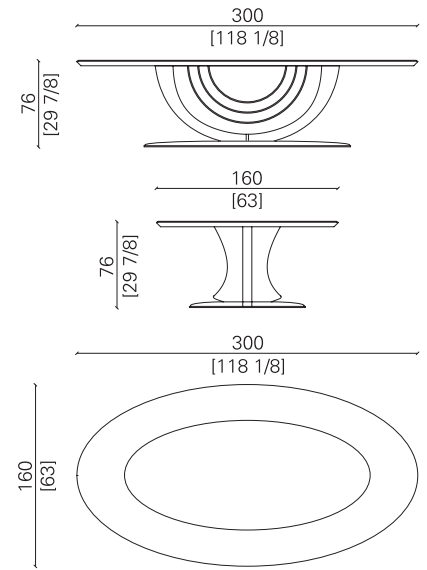
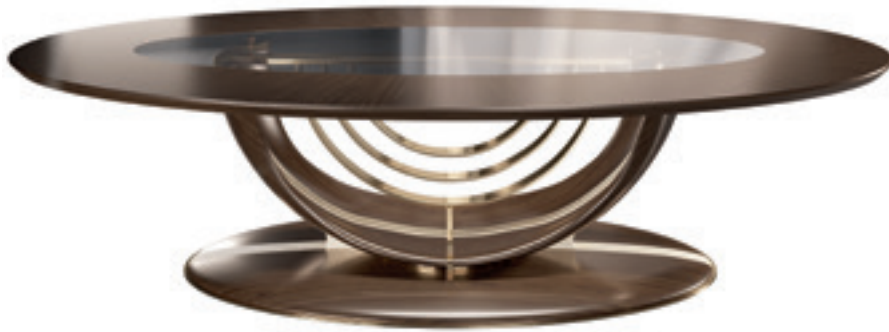

Tavolo ovale con struttura e basamento in massello di noce americano naturale opaco con inserto in acero a contrasto. Piano con cornice in noce americano naturale opaco con parte centrale in vetro extrachiaro stratificato e temperato. Decorazione basamento in ottone in finitura bagno oro lucido.

Oval table with structure and base in natural solid American walnut, with contrasting maple wood insert. Top with matt natural American walnut frame, and centre in extra-clear laminated and tempered glass. Base decoration in brass with shiny gold plated finish.

finiture   finishes		vetro glass					cornice frame					prezzo   price	
piano top	struttura in noce americano opaco con inserto in acero a contrasto structure in matt American walnut, with contrasting maple wood insert												
		<b>VE01</b> vetro extrachiaro extra-clear glass	<b>VE02</b> vetro bronzato bronzed glass	<b>VE03</b> vetro fumé smoked glass	<b>NA01.M</b> noce amer. scuro opaco matt dark American walnut	<b>NA02.M</b> noce amer. naturale opaco matt natural American walnut							
				<b>NA01.M</b> noce amer. scuro opaco matt dark American walnut	<b>NA02.M</b> noce amer. naturale opaco matt natural American walnut								
inserti piano e decorazioni in ottone top inserts and decoration in brass													
		<b>ME01</b> bronzato bronzed	<b>ME02</b> bagno oro lucido shiny gold plated	<b>ME03</b> satinato satin finish	<b>ME04</b> cromo nero lucido shiny black chrome								
		Finitura come da immagine. Finish as shown on image.											<b>€ 49.140,00</b>
		composizioni   compositions											

Altre finiture disponibili su richiesta. | Other finishes available upon request.



# IL PLATANO

## TAVOLO OVALE VARIANTE 3 | OVAL TABLE VARIANT 3

by Vito Lupo

dimensioni | dimensions L300 x P160 x H76 cm  
 peso | weight 405 kg  
 volume | volume 4,50 m<sup>3</sup>

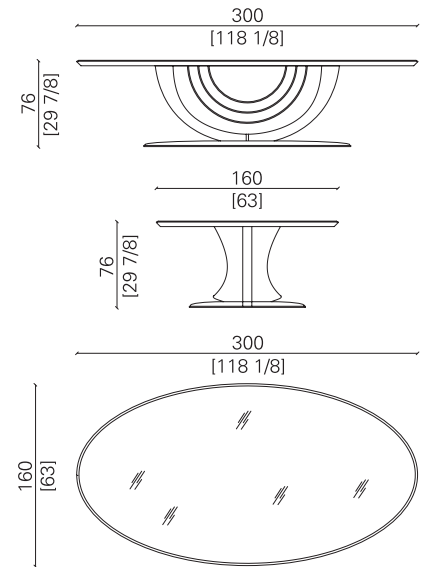

Tavolo ovale con struttura e basamento in massello di noce americano naturale e inserto in acero a contrasto. Piano in vetro extrachiari stratificato e temperato con cornice in massello di noce americano naturale opaco. Decorazione basamento in ottone in finitura bagno oro lucido.

Oval table with structure and base in natural solid American walnut, with contrasting maple wood insert. Laminated and tempered glass top with solid matt natural American walnut frame. Base decoration in brass with shiny gold plated finish.

finiture   finishes		vetro glass					cornice frame		prezzo   price
piano top									
		<b>VE01</b> vetro extrachiari extra-clear glass	<b>VE02</b> vetro bronzato bronzed glass	<b>VE03</b> vetro fumé smoked glass	<b>NA01.M</b> noce amer. scuro opaco matt dark American walnut	<b>NA02.M</b> noce amer. naturale opaco matt natural American walnut			
struttura in noce americano opaco con inserto in acero a contrasto structure in matt American walnut, with contrasting maple wood insert									
		<b>NA01.M</b> noce amer. scuro opaco matt dark American walnut	<b>NA02.M</b> noce amer. naturale opaco matt natural American walnut						
decorazioni in ottone decoration in brass									
		<b>ME01</b> bronzato bronzed	<b>ME02</b> bagno oro lucido shiny gold plated	<b>ME03</b> satinato satin finish	<b>ME04</b> cromo nero lucido shiny black chrome				
		Finitura come da immagine. Finish as shown on image.							
									<b>€ 44.640,00</b>

Altre finiture disponibili su richiesta. | Other finishes available upon request.

# IL PLATANO

## TAVOLO OVALE VARIANTE 4 | OVAL TABLE VARIANT 4

by Vito Lupo

dimensioni | dimensions L300 x P160 x H76 cm  
 peso | weight 325 kg  
 volume | volume 4,50 m<sup>3</sup>

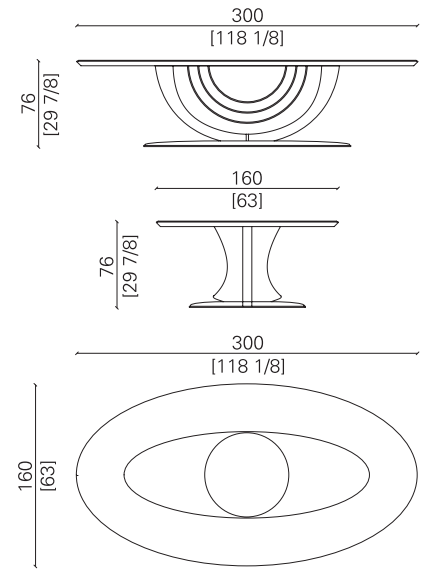

Tavolo ovale con struttura e basamento in massello di noce americano naturale opaco con inserto in acero a contrasto. Piano in noce americano naturale opaco intarsiato con inserto in ottone in finitura bagno oro lucido. Decorazione basamento in ottone lucido in bagno oro lucido.

Oval table with structure and base in natural solid American walnut, with contrasting maple wood insert. Top in matt natural American walnut, with shiny gold plated brass inlay. Base decoration in brass with shiny gold plated finish.

### finiture | finishes

piano in noce americano opaco  
top in matt American walnut



**NA01.M**  
noce amer.  
scuro opaco  
matt dark  
American walnut



**NA02.M**  
noce amer.  
naturale opaco  
matt natural  
American walnut

struttura in noce americano  
opaco con inserto in acero  
a contrasto  
structure in matt American  
walnut finish, with contrasting  
maple wood insert



**NA01.M**  
noce amer.  
scuro opaco  
matt dark  
American walnut

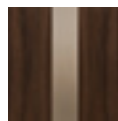

**NA02.M**  
noce amer.  
naturale opaco  
matt natural  
American walnut

inserti piano e decorazioni  
in ottone  
brass top inserts and  
decorations



**ME01**  
bronzato  
bronzed



**ME02**  
bagno oro  
lucido  
shiny gold  
plated



**ME03**  
satinato  
satin finish



**ME04**  
cromo nero lucido  
shiny black chrome

### composizioni | compositions

Finitura come da immagine.  
Finish as shown in image.

### prezzo | price

€ 41.920,00

Altre finiture disponibili su richiesta. | Other finishes available upon request.

# IL CIPRESSO

## TAVOLO RETTANGOLARE | RECTANGULAR TABLE

by Fabio Crippa & Joe Gentile

dimensioni | dimensions L240 x P110 x H76 cm  
 peso | weight 90 kg  
 volume | volume 2,60 m<sup>3</sup>

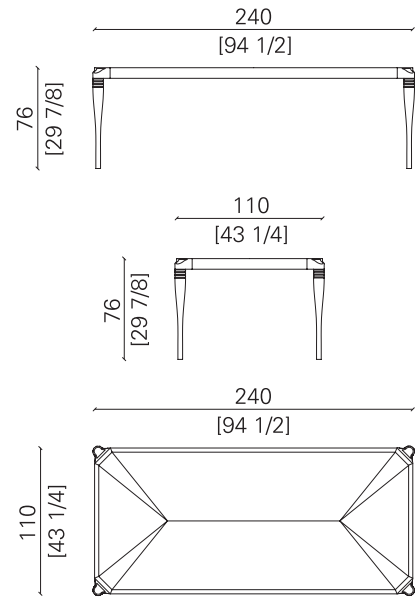

Tavolo rettangolare con struttura e gambe in massello di noce americano tinto scuro lucido. Piano intarsiato in noce americano tinto scuro lucido con inserto in ottone in finitura bagno oro lucido. Gamba con inserti in pietra semipreziosa Occhio di Tigre e dettagli in ottone in finitura bagno oro lucido.

Rectangular table with dark glossy solid American walnut structure and legs. Top with dark glossy American walnut and shiny gold plated brass inlay. Legs with semi-precious Tiger's Eye stone inserts and details in brass with shiny gold plated finish.

### finiture | finishes

struttura in noce americano  
American walnut structure

inserto gamba in pietra  
semipreziosa  
legs with inserts in semi-precious stone

dettagli in ottone  
details in brass

**A** noce americano lucido  
glossy American walnut



**NA01.G**  
noce amer.  
scuro lucido  
glossy dark  
American walnut



**NA02.G**  
noce amer.  
naturale lucido  
glossy natural  
American walnut

**B** noce americano opaco  
matt American walnut



**NA01.M**  
noce amer.  
scuro opaco  
matt dark  
American walnut



**NA02.M**  
noce amer.  
naturale opaco  
matt natural  
American walnut



**PS01**  
Labradorite

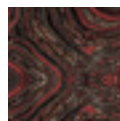

**PS02**  
Ferro Tigrato  
Tiger Iron



**PS03**  
Ametista  
Amethyst



**PS04**  
Occhio di Tigre  
Tiger's Eye



**ME01**  
bronzato  
bronzed



**ME02**  
bagno oro lucido  
shiny gold  
plated



**ME03**  
satinato  
satin finish

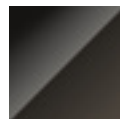

**ME04**  
cromo nero lucido  
shiny black chrome

prezzo | price

### composizioni | compositions

**A.** Tavolo con struttura in noce americano lucido.  
Table with glossy American walnut structure.

€ 18.530,00

**B.** Tavolo con struttura in noce americano opaco.  
Table with matt American walnut structure.

€ 17.730,00

Altre finiture disponibili su richiesta. | Other finishes available upon request.

# L'AGRIFOGLIO

## SEDIA VARIANTE 1 | CHAIR VARIANT 1





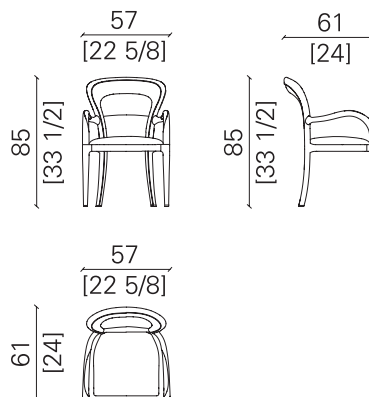

by Fabio Crippa & Joe Gentile

dimensioni | dimensions L57 x P61 x H85 cm  
 peso | weight 22 kg  
 volume | volume 0,46 m<sup>3</sup>

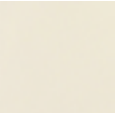

Sedia in massello di noce americano tinto scuro opaco. Imbottitura schienale, interno gambe posteriori, seduta e profilo in pelle con cuciture in tinta. Bracciolo in fusione di bronzo con inserto in pelle con cuciture in tinta. Puntalini in ottone in finitura satinata.

Chair in dark solid American walnut in matt finishing. Backrest, rear legs inner side, seat and profile upholstered in leather with matching stitching. Armrest in bronze casting, with insert in leather with matching stitching. Tips in brass with satin finish.

finiture   finishes			quantità   quantity	prezzo   price	
struttura in noce americano opaco matt American walnut structure	 <b>NA01.M</b> noce amer. scuro opaco matt dark American walnut	 <b>NA02.M</b> noce amer. naturale opaco matt natural American walnut			
imbottitura in pelle leather upholstery	 <b>ZF01634</b> pelle leather	+ altri colori + other colours	<b>3 mq</b>		
bracciolo armrest	 <b>FU01</b> fusione di bronzo bronze casting	puntalini in ottone brass tips	 <b>ME02</b> bagno oro lucido shiny gold plated	 <b>ME03</b> satinato satin finish	
composizioni   compositions	Finitura come da immagine. Finish as shown on image.			<b>€ 6.970,00</b>	

Altre finiture disponibili su richiesta. | Other finishes available upon request.

# L'AGRIFOGLIO

## SEDIA VARIANTE 2 | CHAIR VARIANT 2



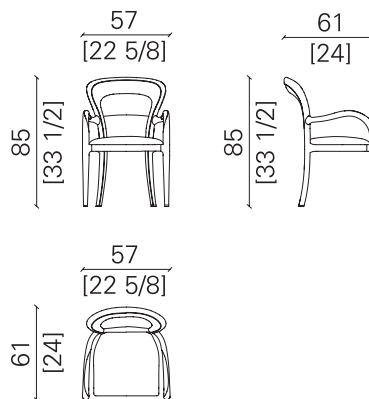

by Fabio Crippa & Joe Gentile

dimensioni | dimensions L57 x P61 x H85 cm  
 peso | weight 8 kg  
 volume | volume 0,46 m<sup>3</sup>

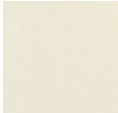

Sedia in massello di noce americano tinto scuro opaco. Imbottitura schienale, interno gambe posteriori, seduta e profilo in pelle con cuciture in tinta. Bracciolo in massello di noce americano tinto scuro opaco con inserto in pelle con cuciture in tinta. Puntalini in ottone in finitura satinata.

Chair in dark solid American walnut in matt finishing. Backrest, rear legs inner part, seat and profile upholstered in leather with matching stitching. Armrest in dark matt solid American walnut, with inlay in leather with matching stitching. Tips in brass with satin finish.

finiture   finishes		quantità   quantity	prezzo   price
struttura in noce americano opaco mat American walnut structure	<div style="display: flex; justify-content: space-around;"> <div style="text-align: center;">   <b>NA01.M</b>                      noce amer. scuro opaco                      matt dark                      American walnut                 </div> <div style="text-align: center;">   <b>NA02.M</b>                      noce amer. naturale opaco                      matt natural                      American walnut                 </div> </div>		
imbottitura in pelle leather upholstery	<div style="display: flex; align-items: center;">  <div style="margin-left: 10px;">                     + altri colori                      + other colours                 </div> </div> <p><b>ZF01634</b> pelle leather</p>	<b>3 mq</b>	
puntalini in ottone brass tips	<div style="display: flex; justify-content: space-around;"> <div style="text-align: center;">   <b>ME02</b>                      bagno oro lucido                      shiny gold plated                 </div> <div style="text-align: center;">   <b>ME03</b>                      satinato                      satin finish                 </div> </div>		
composizioni   compositions	Finitura come da immagine. Finish as shown on image.		<b>€ 5.350,00</b>

Altre finiture disponibili su richiesta. | Other finishes available upon request.

# L'AGRIFOGLIO

## SEDIA VARIANTE 3 | CHAIR VARIANT 3





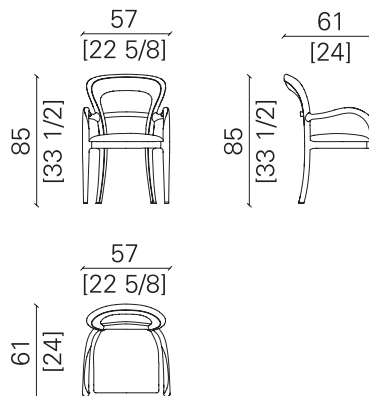

by Fabio Crippa & Joe Gentile

dimensioni | dimensions L57 x P61 x H85 cm  
 peso | weight 8 kg  
 volume | volume 0,46 m<sup>3</sup>

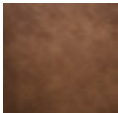

Sedia in massello di noce americano naturale opaco. Schienale in massello a vista, seduta in pelle con cuciture in tinta, profilo in cuoietto intrecciato. Bracciolo in massello di noce americano naturale opaco con inserto in pelle con cuciture in tinta. Puntalini in ottone in finitura satinata.

Chair in dark solid American walnut in natural finishing. Backrest with solid wood finish, seat in leather with matching stitching, piping in plaited leather. Armrest in natural matt solid American walnut, with inlay in leather with matching stitching. Tips in brass with satin finish.

finiture   finishes	quantità   quantity	prezzo   price	
struttura in noce americano opaco matt American walnut structure	<div style="display: flex; justify-content: space-around;"> <div style="text-align: center;">   <b>NA01.M</b>                      noce amer. scuro opaco                      matt dark American walnut                 </div> <div style="text-align: center;">   <b>NA02.M</b>                      noce amer. naturale opaco                      matt natural American walnut                 </div> </div>		
imbottitura in pelle leather upholstery	<div style="display: flex; align-items: center;">  <div style="margin-left: 10px;">                         + altri colori                          + other colours                     </div> </div>	1 mq	
puntalini in ottone brass tips	<div style="display: flex; justify-content: space-around;"> <div style="text-align: center;">   <b>ME02</b>                      bagno oro lucido                      shiny gold plated                 </div> <div style="text-align: center;">   <b>ME03</b>                      satinato                      satin finish                 </div> </div>	 4,5 mtl	
composizioni   compositions	Finitura come da immagine. Finish as shown on image.		<b>€ 4.820,00</b>

Altre finiture disponibili su richiesta. | Other finishes available upon request.

# L'OLEANDRO

## SEDIA | CHAIR

by Fabio Crippa & Joe Gentile

dimensioni | dimensions L62 x P59 x H82 cm  
 peso | weight 17 kg  
 volume | volume 0,46 m<sup>3</sup>

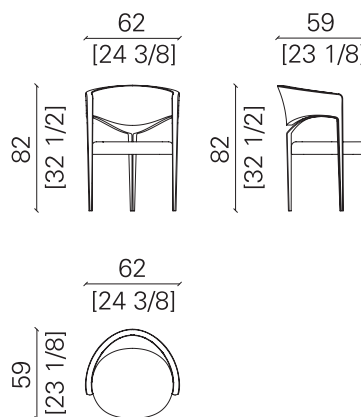

Sedia con tre gambe imbottita in pelle con contra in pelle di struzzo in tinta. Dettaglio della gamba posteriore in ottone in finitura bagno oro lucido con inserto in pelle. Struttura in ottone in finitura bagno oro lucido.

Three-legged chair upholstered in leather, with back upholstered in ostrich leather in matching colour. Rear leg with shiny gold plated brass detailing, with leather insert. Structure in shiny gold plated brass.

finiture   finishes		quantità   quantity	prezzo   price
imbottitura seduta in pelle seat upholstered in leather	 <p>+ altri colori + other colours</p> <p><b>ZF1117</b> pelle leather</p>	5 mq	
imbottitura contra backing upholstery	<p><b>A</b></p>  <p><b>SZ1117</b> pelle di struzzo ostrich leather</p> <p><b>B</b></p>  <p>+ altri colori + other colours</p> <p><b>ZF1117</b> pelle leather</p>	5 mq	
struttura in ottone brass structure	 <p><b>ME01</b> bronzato bronzed</p>  <p><b>ME02</b> bagno oro lucido shiny gold plated</p>  <p><b>ME03</b> satinato satin finish</p>  <p><b>ME04</b> cromo nero lucido shiny black chrome</p>		
composizioni   compositions			
<b>A.</b> Sedia imbottita in pelle con contra in pelle di struzzo. Chair upholstered in leather with ostrich leather backing.			€ 7.960,00
<b>B.</b> Sedia imbottita in pelle. Chair upholstered in leather.			€ 6.900,00

Altre finiture disponibili su richiesta. | Other finishes available upon request.

## IL CORBEZZOLO

### POLTRONCINA | SMALL ARMCHAIR

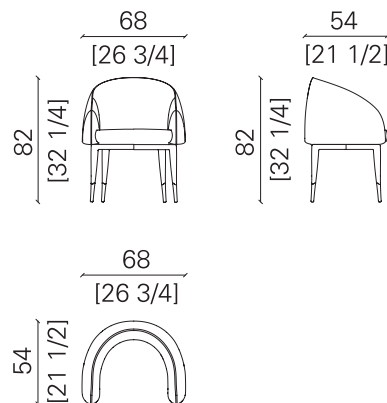

by Fabio Crippa & Joe Gentile

dimensioni | dimensions L68 x P54 x H82 cm  
 peso | weight 14 kg  
 volume | volume 0,46 m<sup>3</sup>

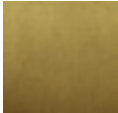

Sedia imbottita in pelle nabuk con contra in pelle di arapaima in tinta. Dettaglio bracciolo con cerniera in finitura cromo nero. Gambe in massello di faggio in finitura laccato nero lucido.

Chair upholstered in nubuck leather with back upholstered in arapaima leather in matching colour. Armrest detailing with zip in black chrome finishing. Legs in solid beech, with glossy black lacquered finish.

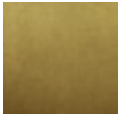
finiture   finishes		quantità   quantity
imbottitura seduta in pelle seat upholstered in leather	 <p>+ altri colori + other colours</p> <p><b>NK2102</b> pelle nabuk nubuck leather</p>	<b>4 mq</b>
<b>A.</b> imbottitura contra in pelle di arapaima backrest upholstered in arapaima leather	 <p>+ altri colori + other colours</p> <p><b>AR2102</b> pelle di arapaima arapaima leather</p>	<b>1,5 mq</b>
<b>B.</b> imbottitura contra in pelle nabuk backrest upholstered in nubuck leather	 <p>+ altri colori + other colours</p> <p><b>NK2102</b> pelle nabuk nubuck leather</p>	<b>1,5 mq</b>

Altre finiture disponibili su richiesta. | Other finishes available upon request.



## IL CORBEZZOLO

POLTRONCINA | SMALL ARMCHAIR

prezzo | price

### finiture | finishes

base  
base

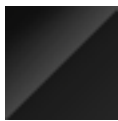

+ altri colori  
+ other colours

**LA05.G**  
laccato lucido  
colore nero  
glossy lacquered  
black colour

cerniera  
zip

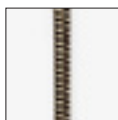

bronzata  
bronzed



dorata  
gilded



cromo nero  
black chrome

### composizioni | compositions

**A.** Poltroncina imbottita in pelle con contra in pelle di arapaima.  
Small armchair upholstered in leather with arapaima leather backing.

€ 5.700,00

**B.** Poltroncina imbottita in pelle.  
Small armchair upholstered in leather.

€ 3.080,00

Altre finiture disponibili su richiesta. | Other finishes available upon request.

## IL PRUGNOLO

### SEDIA | CHAIR



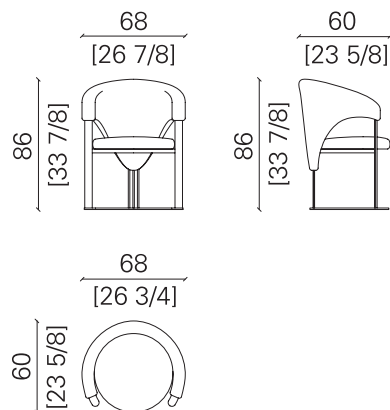

by Fabio Crippa & Joe Gentile

dimensioni | dimensions L68 x P60 x H86 cm  
 peso | weight 18 kg  
 volume | volume 0,52 m<sup>3</sup>

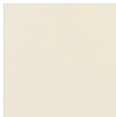

Sedia imbottita in tessuto con profilo in tinta. Struttura in ottone in finitura bagno oro lucido.

Chair upholstered in fabric with matching profile. Structure in shiny gold plated brass.

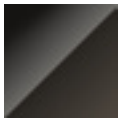
finiture   finishes		quantità   quantity	prezzo   price
A. imbottitura in tessuto upholstered in fabric	 <p><b>ELNB941</b> tessuto fabric</p> <p>+ altri colori + other colours</p>	<b>3 mtl</b>	
	 <p><b>ZF1634</b> pelle leather</p> <p>+ altri colori + other colours</p>		
struttura in ottone brass structure	 <p><b>ME01</b> bronzato bronzed</p>		
	 <p><b>ME02</b> bagno oro lucido shiny gold plated</p>		
	 <p><b>ME03</b> satinato satin finish</p>		
	 <p><b>ME04</b> cromo nero lucido shiny black chrome</p>		
composizioni   compositions			
A. Sedia imbottita in tessuto. Chair upholstered in fabric.			€ 5.300,00
B. Sedia imbottita in pelle. Chair upholstered in leather.			€ 5.320,00

Altre finiture disponibili su richiesta. | Other finishes available upon request.

## IL PRUGNOLO

### POLTRONCINA | SMALL ARMCHAIR



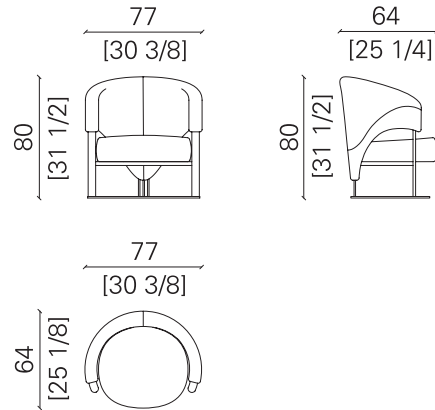

by Fabio Crippa & Joe Gentile

dimensioni | dimensions L77 x P64 x H80 cm  
 peso | weight 22 kg  
 volume | volume 0,60 m<sup>3</sup>

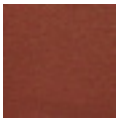
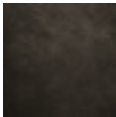

Poltroncina imbottita in tessuto con profilo in tinta. Struttura in ottone in finitura bagno oro lucido.

Small armchair upholstered in fabric with matching profile. Structure in shiny gold plated brass.

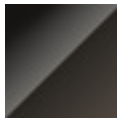
finiture   finishes		quantità   quantity	prezzo   price
A. imbottitura in tessuto upholstered in fabric	 <p>+ altri colori + other colours</p> <p><b>ELNB941</b> tessuto fabric</p>	<b>3 mtl</b>	
B. imbottitura in pelle upholstered in leather	 <p>+ altri colori + other colours</p> <p><b>ET5085</b> pelle leather</p>	<b>5 mq</b>	
struttura in ottone brass structure	 <p><b>ME01</b> bronzato bronzed</p>  <p><b>ME02</b> bagno oro lucido shiny gold plated</p>  <p><b>ME03</b> satinato satin finish</p>  <p><b>ME04</b> cromo nero lucido shiny black chrome</p>		
composizioni   compositions			
A. Poltroncina imbottita in tessuto. Small armchair upholstered in fabric.			€ 5.560,00
B. Poltroncina imbottita in pelle. Small armchair upholstered in leather.			€ 5.940,00

Altre finiture disponibili su richiesta. | Other finishes available upon request.

# LA QUERCIA

## CREDENZA VARIANTE 1 | SIDEBOARD VARIANT 1

by Fabio Crippa & Joe Gentile

dimensioni | dimensions L225 x P57 x H95 cm  
 peso | weight 257 kg  
 volume | volume 1,65 m<sup>3</sup>

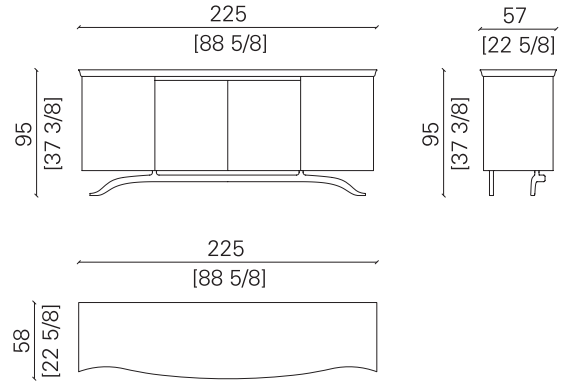

Credenza a sei ante ondulate e struttura in multistrato di pioppo impiallacciata in palissandro scuro lucido. Piano in pietra semipreziosa Labradorite. Maniglie e basamento in fusione di bronzo. Finitura interna e cassetti centrali in erable lucido color blu elettrico con fondo in cuoietto in tinta. Struttura girevole con elementi decorativi in ottone satinato e ripiani girevoli in vetro extrachiaro temperato. Illuminazione interna a LED.

Sideboard with six curved doors and multi-ply poplar structure, veneered in glossy dark rosewood. Top in semi-precious Labradorite stone. Handles and base in cast bronze. Internal finish and central drawers in glossy electric blue colour maple, with bottom in matching leatherette. Swivel structure with decorative elements in brass with satin finish, and swivel shelves in extra-clear tempered glass. LED internal lighting.

### finiture | finishes

piano in pietra semipreziosa  
top in semi-precious stone

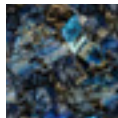

**PS01**  
Labradorite



**PS02**  
Ferro Tigrato  
Tiger Iron



**PS03**  
Ametista  
Amethyst

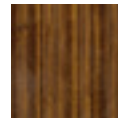

**PS04**  
Occhio di Tigre  
Tiger's Eye

finitura esterna  
external finish



**PL01.G**  
palissandro scuro lucido  
glossy dark rosewood



**LA06.G**  
laccato lucido col. avorio  
glossy lacquered ivory colour



**LA05.G**  
laccato lucido col. nero  
glossy lacquered black colour

finitura interna in erable lucido  
internal finish in glossy maple



**ER01.G**  
erable lucido blu cobalto  
glossy maple cobalt blue



**ER02.G**  
erable lucido rosso marsala  
glossy maple marsala red

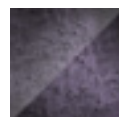

**ER03.G**  
erable lucido ametista  
glossy maple amethyst

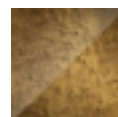

**ER04.G**  
erable lucido giallo oca  
glossy maple ocher yellow



**ERS01.G**  
erable lucido blu elettrico  
glossy maple electric blue

Altre finiture disponibili su richiesta. | Other finishes available upon request.

# LA QUERCIA

## CREDENZA VARIANTE 1 | SIDEBOARD VARIANT 1

prezzo | price

### finiture | finishes

fondo cassetti in cuoietto  
drawer bottoms in leatherette



**CU03**  
col. testa di moro  
brown colour

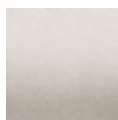

**CU01**  
col. avorio  
ivory colour



**CU04**  
col. nero  
black colour

ripiani in vetro  
glass shelves



**VE01**  
vetro extrach.  
extra-clear  
glass



**VE02**  
vetro bronzato  
bronzed glass



**VE03**  
vetro fumé  
smoked glass

maniglie e basamento  
handles and base

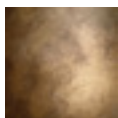

**FU01**  
fusione di bronzo  
bronze casting

### composizioni | compositions

- A.** Credenza con finitura esterna in essenza di legno palissandro scuro lucido e interno in erable lucido.  
Sideboard with glossy dark rosewood external finish, and internal finish in glossy maple. **€ 69.170,00**
- B.** Credenza con finitura esterna in laccato lucido e interno in erable lucido.  
Sideboard with glossy lacquered external finish and internal finish in glossy maple. **€ 62.260,00**

Altre finiture disponibili su richiesta. | Other finishes available upon request.

# LA QUERCIA

## CREDENZA VARIANTE 2 | SIDEBOARD VARIANT 2

by Fabio Crippa & Joe Gentile

dimensioni | dimensions L225 x P57 x H95 cm  
 peso | weight 257 kg  
 volume | volume 1,65 m<sup>3</sup>

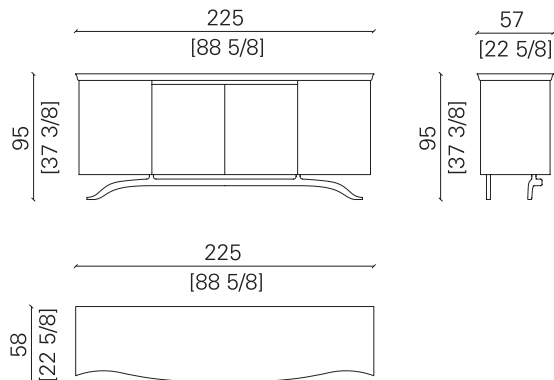

Credenza a sei ante ondulate e struttura in multistrato di pioppo impiallacciata in zebrano lucido. Piano in marmo Noir Saint Laurent. Maniglie e basamento in fusione di bronzo. Finitura interna e cassetti centrali in noce americano tinto scuro lucido con fondo in cuoietto in tinta. Struttura girevole con elementi decorativi in ottone satinato e ripiani girevoli in vetro extrachiaro temperato. Illuminazione interna a LED.

Sideboard with six curved doors and multi-ply poplar structure, veneered in glossy zebrawood. Top in Noir Saint Laurent marble. Handles and base in cast bronze. Internal finish and central drawers in glossy dark American walnut, with bottom in matching leatherette. Swivel structure with decorative elements in brass with satin finish, and swivel shelves in extra-clear tempered glass. LED internal lighting.

### finiture | finishes

piano in marmo  
marble top

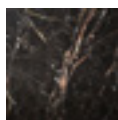

**MA.N02**  
Noir Saint  
Laurent

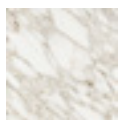

**MA.B01**  
Calacatta  
Vagli Oro

**A.** finitura in essenza di legno  
lucida  
glossy wood finish



**PL01.G**  
palissandro  
scuro lucido  
glossy dark  
rosewood

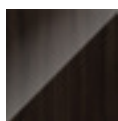

**NA01.G**  
noce amer.  
scuro lucido  
glossy dark  
American  
walnut



**NA02.G**  
noce amer.  
naturale lucido  
glossy natural  
American  
walnut



**ZB01.G**  
zebrano lucido  
glossy  
zebrawood

**B.** finitura in essenza di legno  
opaca  
matt wood finish



**PL01.M**  
palissandro  
scuro opaco  
matt dark  
rosewood



**NA01.M**  
noce amer.  
scuro opaco  
matt dark  
American  
walnut



**NA02.L.M**  
noce amer.  
naturale opaco  
matt natural  
American  
walnut

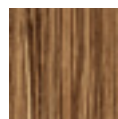

**ZB01.M**  
zebrano opaco  
matt  
zebrawood

Altre finiture disponibili su richiesta. | Other finishes available upon request.

## LA QUERCIA

### CREDENZA VARIANTE 2 | SIDEBOARD VARIANT 2

prezzo | price

#### finiture | finishes

fondo cassetti in cuoietto  
drawer bottoms in leatherette



**CU03**  
col. testa di moro  
brown colour

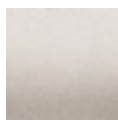

**CU01**  
col. avorio  
ivory colour



**CU04**  
col. nero  
black colour

ripiani in vetro  
glass shelves



**VE01**  
vetro extrach.  
extra-clear  
glass



**VE02**  
vetro bronzato  
bronzed glass



**VE03**  
vetro fumé  
smoked glass

maniglie e basamento  
handles and base

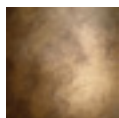

**FU01**  
fusione di bronzo  
bronze casting

#### composizioni | compositions

- |  |                                       |
|--|---------------------------------------|
| <p><b>A.</b> Credenza in essenza di legno lucida con piano in marmo.<br/>Sideboard in glossy wood with marble top.</p> <p>Credenza in essenza di legno opaca con piano in marmo.<br/>Sideboard in matt wood with marble top.</p> | <p>€ 47.660,00</p> <p>€ 44.120,00</p> |
| <p><b>B.</b> Credenza in essenza di legno lucida con piano in essenza.<br/>Sideboard in glossy wood with wood top.</p> <p>Credenza in essenza di legno opaca con piano in essenza.<br/>Sideboard in matt wood with wood top.</p> | <p>€ 46.430,00</p> <p>€ 42.900,00</p> |

Altre finiture disponibili su richiesta. | Other finishes available upon request.

# LA QUERCIA

## CREDENZA VARIANTE 3 | SIDEBOARD VARIANT 3

by Fabio Crippa & Joe Gentile

dimensioni | dimensions L225 x P57 x H95 cm  
 peso | weight 257 kg  
 volume | volume 1,65 m<sup>3</sup>

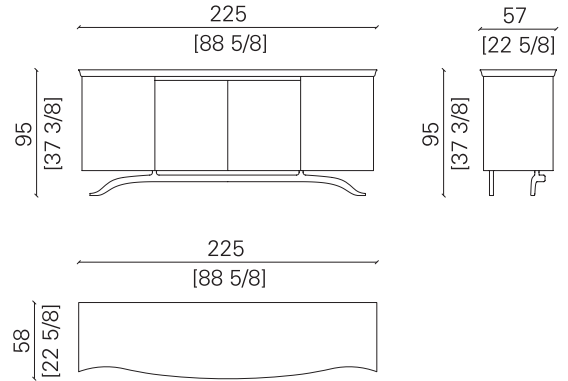

Credenza a sei ante ondulate e struttura in multistrato di pioppo in laccato lucido. Piano in marmo Bronze Amani. Maniglie e basamento in fusione di bronzo. Finitura interna e cassetti centrali in noce americano tinto scuro lucido con fondo in cuoietto in tinta. Struttura girevole con elementi decorativi in ottone satinato e ripiani girevoli in vetro extrachiaro temperato. Illuminazione interna a LED.

Sideboard with six curved doors and multi-ply poplar structure, with glossy lacquered finish. Top in Bronze Amani marble. Handles and base in cast bronze. Internal finish and central drawers in glossy dark American walnut, with bottom in matching leatherette. Swivel structure with decorative elements in brass with satin finish, and swivel shelves in extra-clear tempered glass. LED internal lighting.

### finiture | finishes

piano in marmo  
marble top

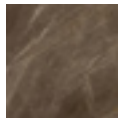

**MA.T02**  
Bronze Amani

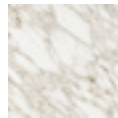

**MA.B01**  
Calacatta  
Vagli Oro

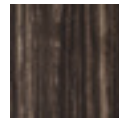

**MA.T01**  
Eramosa

finitura esterna in laccato lucido  
glossy lacquered external finish



**LA06.G**  
laccato lucido  
col. avorio  
glossy  
lacquered  
ivory colour



**LA07.G**  
laccato lucido  
col. tortora  
glossy  
lacquered dove  
grey colour

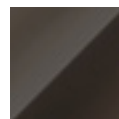

**LA08.G**  
laccato lucido  
col. testa di moro  
glossy lacquered  
brown colour

finitura interna in noce  
americano lucido  
internal finish in glossy  
American walnut

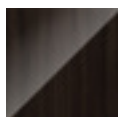

**NA01.G**  
noce amer.  
scuro lucido  
glossy dark  
American  
walnut



**NA02.G**  
noce amer.  
naturale lucido  
glossy natural  
American  
walnut

Altre finiture disponibili su richiesta. | Other finishes available upon request.



# LA QUERCIA

## CREDENZA VARIANTE 3 | SIDEBOARD VARIANT 3

prezzo | price

### finiture | finishes

fondo cassetti in cuoietto  
drawer bottoms in leatherette



**CU03**  
col. testa di moro  
brown colour

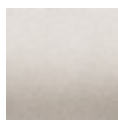

**CU01**  
col. avorio  
ivory colour



**CU04**  
col. nero  
black colour

ripiani in vetro  
glass shelves



**VE01**  
vetro extrach.  
extra-clear  
glass



**VE02**  
vetro bronzato  
bronzed glass



**VE03**  
vetro fumé  
smoked glass

maniglie e basamento  
handles and base

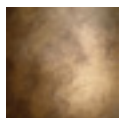

**FU01**  
fusione di bronzo  
bronze casting

### composizioni | compositions

Finitura come da immagine.  
Finish as shown in image.

€ 39.520,00

Altre finiture disponibili su richiesta. | Other finishes available upon request.

# LA PALMA

## CREDENZA | SIDEBOARD

by Fabio Crippa & Joe Gentile

dimensioni | dimensions L231 x P56 x H90 cm  
 peso | weight 230 kg  
 volume | volume 1,60 m<sup>3</sup>

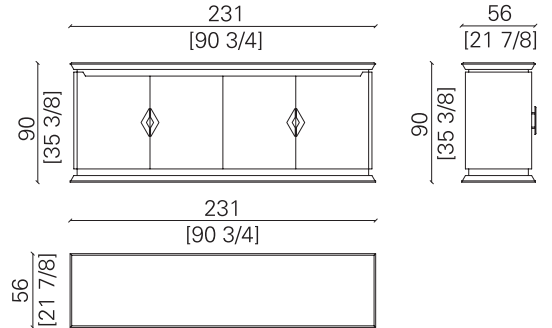
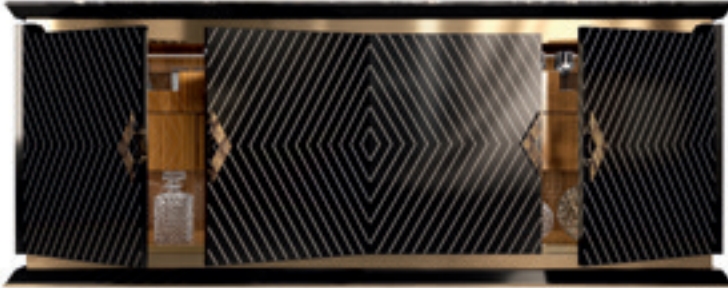

Credenza a quattro ante con top in marmo Nero Marquina, struttura in multistrato di pioppo, esterno in finitura eucalipto frisè lucido color nero ed ante fronte/retro e schienale con intarsio a righe in contrasto. Decorazioni, elementi sottopiano e basamento in ottone in finitura bagno oro lucido. Maniglie in ottone in finitura bagno oro lucido con inserti in pietra semipreziosa Occhio di Tigre. Interno e cassetti impiallacciati in zebrano lucido, inserti in vetro fumè temperato e fondo cassetti in cuoietto in tinta con cuciture in contrasto.

Sideboard with four doors, top in Nero Marquina marble, multi-ply poplar structure, glossy black frisè eucalyptus external finish, with door front/back and back panel inlayed with contrasting strips. Decorations, elements under the top and base in brass, with shiny gold plated finish. Handles in shiny gold plated brass, with semi-precious Tiger's Eye stone inserts. Internal part and drawers veneered in glossy zebrawood, inserts in tempered smoked glass, and drawer bottoms in matching leatherette with contrasting stitching.

### finiture | finishes

piano in marmo  
marble top



**MA.N01**  
Nero Marquina

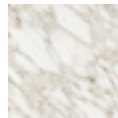

**MA.B01**  
Calacatta  
Vagli Oro

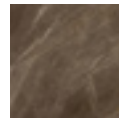

**MA.T02**  
Bronze Amani

**A.** rivestimento in eucalipto  
frisè lucido con intarsi a  
contrasto  
cladding in glossy frisè  
eucalyptus, with contrasting  
inlays

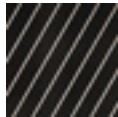

**EF105.G**  
eucalipto frisè  
col. nero  
frisè eucalyptus  
black colour

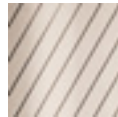

**EF106.G**  
eucalipto frisè  
col. avorio  
frisè eucalyptus  
ivory colour



**EF107.G**  
eucalipto frisè  
col. tortora  
frisè eucalyptus  
dove grey colour

**B.** rivestimento in eucalipto  
frisè  
cladding in frisè eucalyptus



**EF05.G**  
eucalipto  
col. nero  
eucalyptus  
black colour



**EF06.G**  
eucalipto  
col. avorio  
eucalyptus  
ivory colour

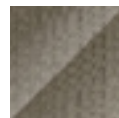

**EF07.G**  
eucalipto  
col. tortora  
eucalyptus  
dove grey colour

Altre finiture disponibili su richiesta. | Other finishes available upon request.

# LA PALMA

## CREDENZA | SIDEBOARD

prezzo | price

### finiture | finishes

finitura interna  
internal finish

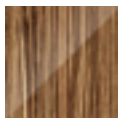

**ZB01.G**  
zebrano lucido  
glossy  
zebrawood

frontali cassetti in vetro  
glass drawer fronts



**VE01**  
vetro extrach.  
extra-clear  
glass



**VE02**  
vetro bronzato  
bronzed glass



**VE03**  
vetro fumé  
smoked glass

inserto maniglia in pietra  
semipreziosa  
handle with inserts in semi-  
precious stone

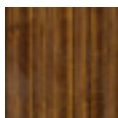

**PS04**  
Occhio di Tigre  
Tiger's Eye

maniglie e decorazione  
in ottone  
handles and decorations in  
brass



**ME01**  
bronzato  
bronzed



**ME02**  
bagno oro  
lucido  
shiny gold  
plated



**ME03**  
satinato  
satin finish



**ME04**  
cromo nero lucido  
shiny black chrome

fondo cassetti in cuoietto  
con cuciture in contrasto  
drawer bottoms in leatherette  
with contrasting stitching

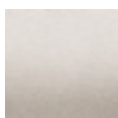

**CU01**  
col. avorio  
ivory colour



**CU04**  
col. nero  
black colour

### composizioni | compositions

**A.** Credenza con rivestimento ante in eucalipto frisè lucido con intarsi in contrasto.  
Sideboard with door cladding in glossy frisè eucalyptus, with contrasting inlays.

€ 39.490,00

**B.** Credenza con rivestimento ante in eucalipto frisè.  
Sideboard with door cladding in frisè eucalyptus.

€ 37.250,00

Altre finiture disponibili su richiesta. | Other finishes available upon request.

# LA CAMELIA

## CREDENZA | SIDEBBOARD

by Fabio Crippa & Joe Gentile

dimensioni | dimensions L221 x P56 x H80 cm  
 peso | weight 345 kg  
 volume | volume 1,40 m<sup>3</sup>

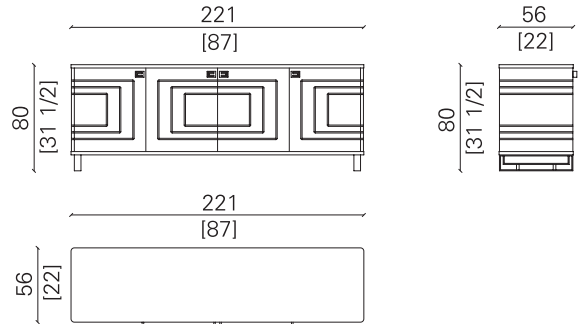

Credenza a quattro ante con struttura in marmo Nero Marquina con intarsi bianchi a contrasto. Basamento e maniglie in ottone in finitura cromo nero lucido. Interno in erable lucido color rosso rubino e cassetti centrali con fondo in cuoietto in tinta con cuciture in contrasto.

Sideboard with four doors, Nero Marquina marble structure, and contrasting white inlays. Base and handles in shiny black chrome finish. Internal finish in ruby red glossy maple, and central drawers with bottom in matching leatherette and contrasting stitching.

### finiture | finishes

finitura esterna in marmo con intarsio a contrasto  
 external finish in marble with contrasting inlay

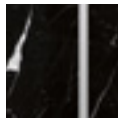

**MA.N01**  
 Nero Marquina  
 con inserto bianco  
 with white insert

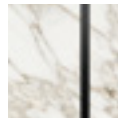

**MA.B01**  
 Calacatta Vagli Oro  
 con inserto nero  
 with black insert

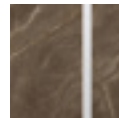

**MA.T02**  
 Bronze Amani  
 con inserto bianco  
 with white insert

**A.** finitura interna in erable lucido  
 internal finish in glossy maple

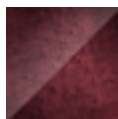

**ERS02.G**  
 erable lucido  
 rosso rubino  
 glossy maple  
 ruby colour



**ER05.G**  
 erable lucido  
 col. nero  
 glossy maple  
 black colour



**ER06.G**  
 erable lucido  
 col. avorio  
 glossy maple  
 ivory colour

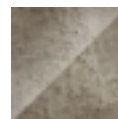

**ERS07.G**  
 erable lucido  
 col. tortora  
 glossy maple  
 dove grey colour

**B.** finitura interna in laccato lucido  
 glossy lacquered internal finish

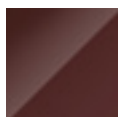

**LAS02.G**  
 laccato lucido  
 col. rubino  
 glossy  
 lacquered  
 ruby colour



**LA05.G**  
 laccato lucido  
 col. nero  
 glossy  
 lacquered  
 black colour



**LA06.G**  
 laccato lucido  
 col. avorio  
 glossy  
 lacquered  
 ivory colour

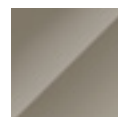

**LA07.G**  
 laccato lucido  
 col. tortora  
 glossy lacquered  
 dove grey colour

Altre finiture disponibili su richiesta. | Other finishes available upon request.

## LA CAMELIA

### CREDENZA | SIDEBOARD

prezzo | price

#### finiture | finishes

maniglie e decorazione  
in ottone  
handles and decoration in brass

fondo cassetti in cuoietto  
con cuciture in contrasto  
drawer bottoms in leatherette  
with contrasting stitching



**ME01**  
bronzato  
bronzed



**ME02**  
bagno oro  
lucido  
shiny gold  
plated



**ME03**  
satinato  
satin finish



**ME04**  
cromo nero lucido  
shiny black chrome

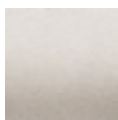

**CU14**  
col. avorio  
ivory colour



**CU21**  
col. nero  
black colour

#### composizioni | compositions

**A.** Credenza con finitura interna in erable lucido.  
Sideboard with glossy maple internal finish.

€ 42.300,00

**B.** Credenza con finitura interna in laccato lucido.  
Sideboard with glossy lacquered internal finish.

€ 35.300,00

Altre finiture disponibili su richiesta. | Other finishes available upon request.



**IL SALOTTO**  
THE LIVING ROOM

## L'EUCALIPTO

### DIVANO TRE POSTI | THREE-SEATER SOFA

by Fabio Crippa & Joe Gentile

dimensioni | dimensions L246 x P92 x H91 cm  
 peso | weight 60 kg  
 volume | volume 2,60 m<sup>3</sup>

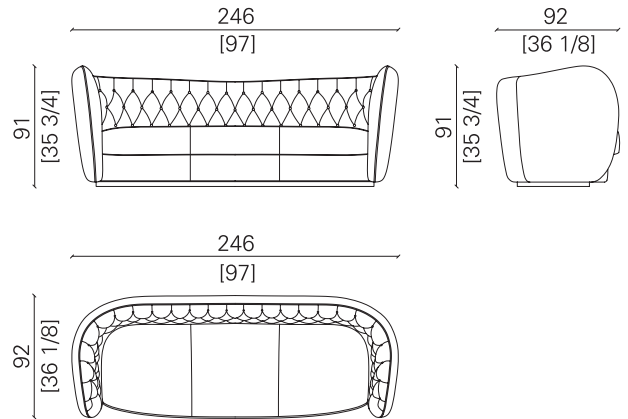



Divano imbottito in pelle nabuk con schienale interno con lavorazione capitonnè eseguita a mano. Imbottitura in poliuretano espanso a densità differenziata con rivestimento in fibra acrilica. Basamento in palissandro tinto scuro.

Sofa upholstered in nubuck leather, with hand crafted capitonnè backrest. Padding in foam polyurethane of varying density, with acrylic fiber cover. Base in dark rosewood.

#### finiture | finishes

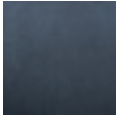
imbottitura seduta e schienale  
 seat and backrest upholstery

**A**  
  
**17 mq**  
**NK2108**  
 pelle nabuk  
 nubuck leather

**B**  
  
**10 mtl** + altri colori  
 + other colours  
**LPAL043**  
 velluto  
 velvet

imbottitura contra  
 back upholstery

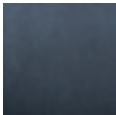
**A**  
  
**8 mq**  
**NK2108**  
 pelle nabuk  
 nubuck leather

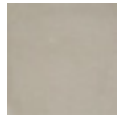
**B**  
  
**6 mtl** + altri colori  
 + other colours  
**LPAL043**  
 velluto  
 velvet

basamento in palissandro  
 tinto scuro  
 base in dark rosewood

  
**PL01**  
 palissandro  
 tinto scuro  
 dark rosewood

prezzo | price

#### composizioni | compositions

**AA.** Imbottitura divano in pelle nabuk.  
 Sofa upholstered in nubuck leather. **€ 14.850,00**

**BA.** Imbottitura seduta e schienale divano in velluto capitonnè, imbottitura contra in pelle nabuk.  
 Seat and backrest with velvet capitonnè upholstery, back upholstered in nubuck leather. **€ 13.540,00**

**BB.** Imbottitura divano in velluto.  
 Sofa upholstered in velvet. **€ 13.220,00**

Altre finiture disponibili su richiesta. | Other finishes available upon request.







## L'EUCALIPTO

### DIVANO TRE POSTI | THREE-SEATER SOFA

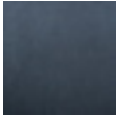
quantità | quantity

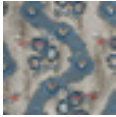
prezzo | price

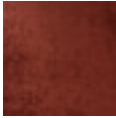
cuscini   cushions					
<p>cuscino strutturale 50x50 cm x 1pz structural cushion 50x50 cm x 1 pc</p>	 <p>+ altri colori + other colours</p>	<p><b>NK2108</b> pelle nabuk nubuck leather</p>	1,5 mq	€	<b>320,00</b>
<p>cuscino strutturale 50x50 cm x 1pz structural cushion 50x50 cm x 1 pc</p>	 <p>+ altri colori + other colours</p>	<p><b>LPAL043</b> velluto velvet</p>	0,6 mtl	€	<b>180,00</b>
<p>cuscino decorativo A 50x50 cm x 1pz decorative cushion A 50x50 cm x 1 pc</p>	 <p>+ altri colori + other colours</p>	<p><b>DEDM004</b> tessuto fabric</p>	0,6 mtl	€	<b>330,00</b>
<p>cuscino decorativo B 50x50 cm x 1pz decorative cushion B 50x50 cm x 1 pc</p>	 <p>+ altri colori + other colours</p>	<p><b>LPLL021</b> tessuto fabric</p>	0,6 mtl	€	<b>210,00</b>
<p>cuscino decorativo C 40x40 cm x 1pz decorative cushion C 40x40 cm x 1 pc</p>	 <p>+ altri colori + other colours</p>	<p><b>LPAL012</b> velluto velvet</p>	0,5 mtl	€	<b>150,00</b>

Altre finiture disponibili su richiesta. | Other finishes available upon request.

## L'EUCALIPTO

### POLTRONA | ARMCHAIR



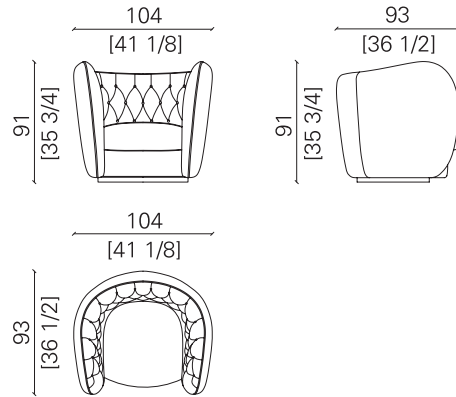

by Fabio Crippa & Joe Gentile

dimensioni | dimensions L104 x P93 x H91 cm  
 peso | weight 30 kg  
 volume | volume 1,18 m<sup>3</sup>

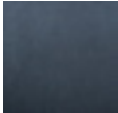

Poltrona con imbottitura contra in pelle nabuk, interno in velluto con lavorazione capitonnè eseguita a mano. Imbottitura in poliuretano espanso a densità differenziata con rivestimento in fibra acrilica. Basamento in palissandro tinto scuro.

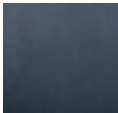
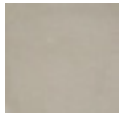
Armchair with backing upholstered in nubuck leather, seat and backrest in hand crafted capitonnè velvet upholstery. Padding in foam polyurethane of varying density, with acrylic fiber cover. Base in dark rosewood.

finiture   finishes				prezzo   price	
imbottitura seduta e schienale seat and backrest upholstery	<p><b>A</b></p>  <p><b>10 mq</b></p> <p><b>NK2108</b> pelle nabuk nubuck leather</p>	<p><b>B</b></p>  <p><b>5 mtl</b></p> <p><b>LPAL043</b> velluto velvet</p>		+ altri colori + other colours	
imbottitura contra back upholstery	<p><b>A</b></p>  <p><b>7 mq</b></p> <p><b>NK2108</b> pelle nabuk nubuck leather</p>	<p><b>B</b></p>  <p><b>3,5 mtl</b></p> <p><b>LPAL043</b> velluto velvet</p>		+ altri colori + other colours	
basamento in palissandro tinto scuro base in dark rosewood	 <p><b>PL01</b> palissandro tinto scuro dark rosewood</p>				
composizioni   compositions					
<b>AA.</b> Imbottitura poltrona in pelle nabuk. Armchair upholstered in nubuck leather.				€ 9.720,00	
<b>BA.</b> Imbottitura seduta e schienale poltrona in velluto capitonnè, imbottitura contra in pelle nabuk. Armchair seat and backrest with velvet capitonnè upholstery, back upholstered in nubuck leather.				€ 8.740,00	
<b>BB.</b> Imbottitura poltrona in velluto. Armchair upholstered in velvet.				€ 8.060,00	

Altre finiture disponibili su richiesta. | Other finishes available upon request.

## L'EUCALIPTO

### POLTRONA | ARMCHAIR

quantità | quantity      prezzo | price

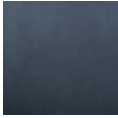
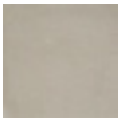
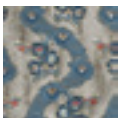
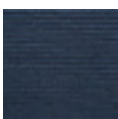
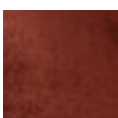
cuscini   cushions					
<p>cuscino strutturale 50x50 cm x 1pz structural cushion 50x50 cm x 1 pc</p>	 <p>+ altri colori + other colours</p>	<p><b>NK2108</b> pelle nabuk nubuck leather</p>	1,5 mq	€	<b>320,00</b>
<p>cuscino strutturale 50x50 cm x 1pz structural cushion 50x50 cm x 1 pc</p>	 <p>+ altri colori + other colours</p>	<p><b>LPAL043</b> velluto velvet</p>	0,6 mtl	€	<b>180,00</b>
<p>cuscino decorativo A 50x50 cm x 1pz decorative cushion A 50x50 cm x 1 pc</p>	 <p>+ altri colori + other colours</p>	<p><b>DEDM004</b> tessuto fabric</p>	0,6 mtl	€	<b>330,00</b>
<p>cuscino decorativo B 50x50 cm x 1pz decorative cushion B 50x50 cm x 1 pc</p>	 <p>+ altri colori + other colours</p>	<p><b>LPLL021</b> tessuto fabric</p>	0,6 mtl	€	<b>210,00</b>
<p>cuscino decorativo C 40x40 cm x 1pz decorative cushion C 40x40 cm x 1 pc</p>	 <p>+ altri colori + other colours</p>	<p><b>LPAL012</b> velluto velvet</p>	0,5 mtl	€	<b>150,00</b>

Altre finiture disponibili su richiesta. | Other finishes available upon request.

## L'EUCALIPTO

### POLTRONA VIS-À-VIS VARIANTE 1 | VIS-À-VIS ARMCHAIR VARIANT 1

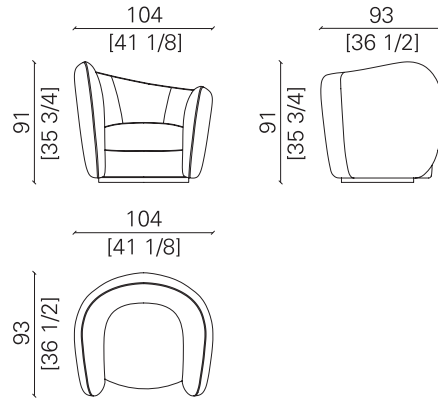

by Fabio Crippa & Joe Gentile

dimensioni | dimensions L104 x P93 x H91 cm  
 peso | weight 28 kg  
 volume | volume 1,18 m<sup>3</sup>



Poltrona vis-à-vis sinistra o destra imbottita in velluto. Imbottitura in poliuretano espanso a densità differenziata con rivestimento in fibra acrilica. Frangia decorativa in tinta. Basamento in palissandro tinto scuro.

Left or right side vis-à-vis armchair upholstered in velvet. Padding in foam polyurethane of varying density, with acrylic fiber cover. Matching decorative fringe. Base in dark rosewood.

finiture   finishes		quantità   quantity	prezzo   price
imbottitura seduta e schienale seat and backrest upholstery	 + altri colori + other colours  <b>ZNSH013</b> velluto velvet	7,5 mtl	
frangia in tinta matching fringe	 + altri colori + other colours  frangia decorativa decorative fringe	1 mtl	
basamento in palissandro tinto scuro base in dark rosewood	  <b>PL01</b> palissandro tinto scuro dark rosewood		
composizioni   compositions	Imbottitura poltrona vis-à-vis in velluto con frangia decorativa in tinta. Vis-à-vis armchair with velvet upholstery and matching decorative fringe.		€ 7.710,00



Altre finiture disponibili su richiesta. | Other finishes available upon request.

## L'EUCALIPTO

POLTRONA VIS-À-VIS VARIANTE 1 | VIS-À-VIS ARMCHAIR VARIANT 1

quantità | quantity

prezzo | price

cuscini   cushions					
<p>cuscino strutturale 50x50 cm x 1pz structural cushion 50x50 cm x 1 pc</p>	 <p>+ altri colori + other colours</p> <p><b>ZNSH013</b> velluto velvet</p>	0,6 mtl	€	<b>190,00</b>	
<p>cuscino decorativo A 50x50 cm x 1pz decorative cushion A 50x50 cm x 1 pc</p>	 <p>+ altri colori + other colours</p> <p><b>NBSN15</b> tessuto fabric</p>	0,6 mtl	€	<b>210,00</b>	
<p>cuscino decorativo B 40x40 cm x 1pz decorative cushion B 40x40 cm x 1 pc</p>	 <p>+ altri colori + other colours</p> <p><b>NBVR45</b> velluto velvet</p>	0,5 mtl	€	<b>220,00</b>	

Altre finiture disponibili su richiesta. | Other finishes available upon request.

## L'EUCALIPTO

### POLTRONA VIS-À-VIS VARIANTE 2 | VIS-À-VIS ARMCHAIR VARIANT 2

by Fabio Crippa & Joe Gentile

dimensioni | dimensions L104 x P93 x H91 cm  
 peso | weight 28 kg  
 volume | volume 1,18 m<sup>3</sup>

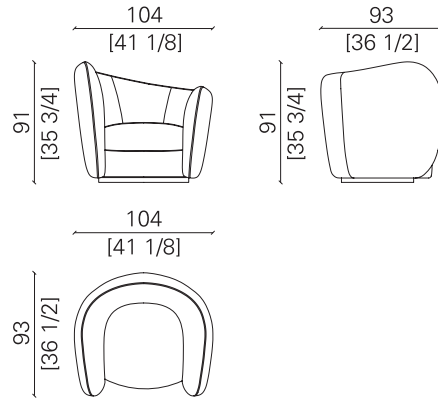

Poltrona vis-à-vis sinistra o destra con contra in pelle nabuk e interno imbottito in velluto. Imbottitura in poliuretano espanso a densità differenziata con rivestimento in fibra acrilica. Basamento in palissandro tinto scuro.

Left or right side vis-à-vis armchair, upholstered in leather on the back and upholstered in velvet on the inside. Padding in foam polyurethane of varying density, with acrylic fiber cover. Base in dark rosewood.

#### finiture | finishes

imbottitura seduta e schienale  
 seat and backrest upholstery

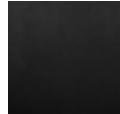
**A**  
  
**NK2138**  
 pelle nabuk  
 nubuck leather

8 mq

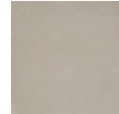
**B**  
  
**LPAL043**  
 velluto  
 velvet

4 mtl

+ altri colori  
 + other colours

imbottitura contra  
 back upholstery

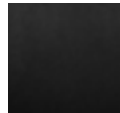
**A**  
  
**NK2138**  
 pelle nabuk  
 nubuck leather

7 mq

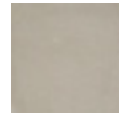
**B**  
  
**LPAL043**  
 velluto  
 velvet

3,5 mtl

+ altri colori  
 + other colours

basamento in palissandro  
 tinto scuro  
 base in dark rosewood

**PL01**  
  
 palissandro  
 tinto scuro  
 dark rosewood

#### composizioni | compositions

**AA.** Imbottitura poltrona in pelle nabuk.  
 Armchair upholstered in nubuck leather.

€ 8.850,00

**BA.** Imbottitura seduta e schienale poltrona in velluto capitonné, imbottitura contra in pelle nabuk.  
 Armchair seat and backrest with velvet capitonné upholstery, back upholstered in nubuck leather.

€ 8.070,00

**BB.** Imbottitura poltrona in velluto.  
 Armchair upholstered in velvet.

€ 7.380,00





Altre finiture disponibili su richiesta. | Other finishes available upon request.

## L'EUCALIPTO

### POLTRONA VIS-À-VIS VARIANTE 2 | VIS-À-VIS ARMCHAIR VARIANT 2

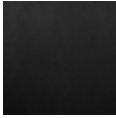
quantità | quantity

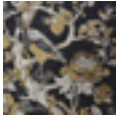
prezzo | price

cuscini   cushions					
<p>cuscino strutturale 50x50 cm x 1pz structural cushion 50x50 cm x 1 pc</p>	<p>Imbottitura cuscini in piuma d'oca. Profilo in tinta o in contrasto. Ducks' down cushion filling. Matching or contrasting piping.</p>	 <p>+ altri colori + other colours</p>	1,5 mq	€	320,00
	<p><b>NK2138</b> pelle nabuk nubuck leather</p>				
<p>cuscino strutturale 50x50 cm x 1pz structural cushion 50x50 cm x 1 pc</p>		 <p>+ altri colori + other colours</p>	0,6 mtl	€	180,00
	<p><b>LPAL043</b> velluto velvet</p>				
<p>cuscino decorativo A 50x50 cm x 1pz decorative cushion A 50x50 cm x 1 pc</p>		 <p>+ altri colori + other colours</p>	0,6 mtl	€	270,00
	<p><b>DESJ001</b> tessuto fabric</p>				
<p>cuscino decorativo B 50x50 cm x 1pz decorative cushion B 50x50 cm x 1 pc</p>		 <p>+ altri colori + other colours</p>	0,6 mtl	€	220,00
	<p><b>NBKJ023</b> tessuto fabric</p>				
<p>cuscino decorativo C 40x40 cm x 1pz decorative cushion C 40x40 cm x 1 pc</p>		 <p>+ altri colori + other colours</p>	0,5 mtl	€	140,00
	<p><b>PFGL005</b> tessuto fabric</p>				

Altre finiture disponibili su richiesta. | Other finishes available upon request.

## IL CASTAGNO

### DIVANO TRE POSTI | THREE-SEATER SOFA

by Vito Lupo

dimensioni | dimensions L242 x P98 x H86 cm  
 peso | weight 95 kg  
 volume | volume 2,66 m<sup>3</sup>

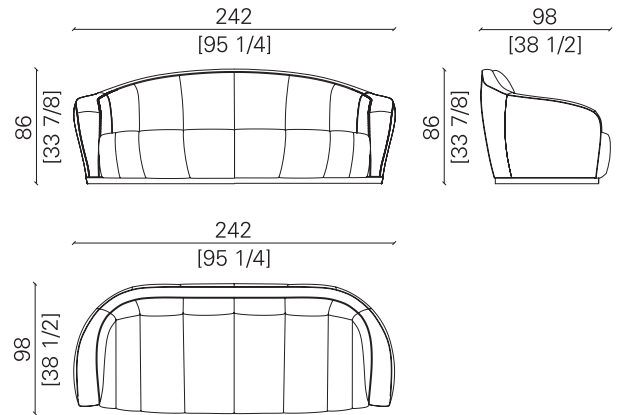

Divano imbottito in pelle nabuk con cuciture decorative verticali. Contra rivestito in tessuto intrecciato. Bracciolo e basamento in massello di frassino tinto scuro in finitura lucida. Imbottitura in poliuretano espanso a densità differenziata con rivestimento in fibra acrilica.

Sofa upholstered in nubuck leather, with decorative vertical stitching. External upholstery in plaited fabric. Armrest and base in dark glossy solid ash wood. Padding in foam polyurethane of varying density, with acrylic fiber cover.

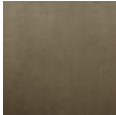
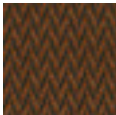
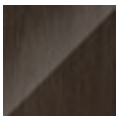
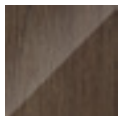
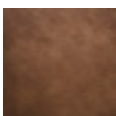
finiture   finishes		quantità   quantity	prezzo   price
imbottitura seduta e schienale seat and backrest upholstery	 <p><b>NK2132</b> pelle nabuk nubuck leather</p> <p>+ altri colori + other colours</p>	<b>22 mq</b>	
imbottitura contra back upholstery	 <p><b>MSPT201</b> tessuto intrecciato plaited fabric</p> <p>+ altri colori + other colours</p>	<b>3,5 mtl</b>	
A. bracciolo in essenza lucida armrest in glossy wood	 <p><b>FS01G</b> frassino scuro lucido glossy dark ash wood</p>		
	 <p><b>FS02G</b> frassino chiaro lucido glossy light ash wood</p>		
B. bracciolo in pelle armrest in leather	 <p><b>ET5081</b> pelle leather</p> <p>+ altri colori + other colours</p>	<b>2,5 mq</b>	
composizioni   compositions	Finitura come da immagine. Finish as shown on image.		<b>€ 27.320,00</b>

Altre finiture disponibili su richiesta. | Other finishes available upon request.





## IL CASTAGNO

### DIVANO TRE POSTI | THREE-SEATER SOFA

quantità | quantity

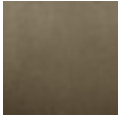
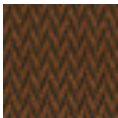
prezzo | price

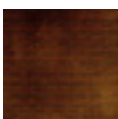
cuscini   cushions					
<p>cuscino strutturale 50x50 cm x 1pz structural cushion 50x50 cm x 1 pc</p>	 <p>+ altri colori + other colours</p>	<p><b>NK2132</b> pelle nabuk nubuck leather</p>	1,5 mq	€	<b>320,00</b>
<p>cuscino decorativo A 50x50 cm x 1pz decorative cushion A 50x50 cm x 1 pc</p>	 <p>+ altri colori + other colours</p>	<p><b>MSPT201</b> tessuto intrecciato plaited fabric</p>	0,6 mtl	€	<b>320,00</b>
<p>cuscino decorativo B 50x50 cm x 1pz decorative cushion B 50x50 cm x 1 pc</p>	 <p>+ altri colori + other colours</p>	<p><b>MSPE701</b> velluto velvet</p>	0,6 mtl	€	<b>240,00</b>
<p>cuscino decorativo C 40x40 cm x 1pz decorative cushion C 40x40 cm x 1 pc</p>	 <p>+ altri colori + other colours</p>	<p><b>MSAN601</b> velluto velvet</p>	0,5 mtl	€	<b>210,00</b>

Altre finiture disponibili su richiesta. | Other finishes available upon request.

# IL CASTAGNO

## POLTRONA | ARMCHAIR

by Vito Lupo

dimensioni | dimensions L107 x P96 x H77 cm  
 peso | weight 50 kg  
 volume | volume 1,10 m<sup>3</sup>

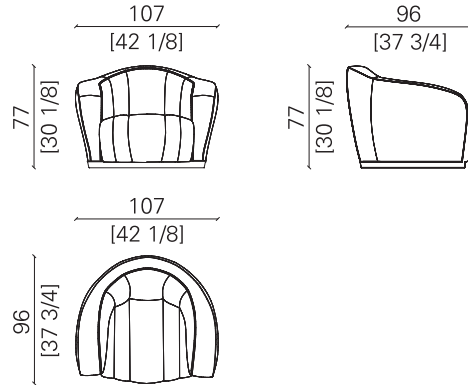

Poltrona imbottita in pelle nabuk con cuciture decorative verticali. Contra rivestito in tessuto intrecciato. Bracciolo e basamento in massello di frassino tinto scuro in finitura lucida. Imbottitura in poliuretano espanso a densità differenziata con rivestimento in fibra acrilica.

Armchair upholstered in nubuck leather, with decorative vertical stitching. External upholstery in plaited fabric. Armrest and base in dark glossy solid ash wood. Padding in foam polyurethane of varying density, with acrylic fiber cover.

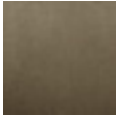
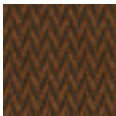
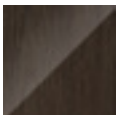
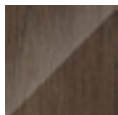
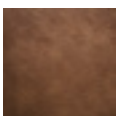



finiture   finishes		quantità   quantity	prezzo   price
imbottitura seduta e schienale seat and backrest upholstery	 <p><b>NK2132</b> pelle nabuk nubuck leather</p> <p>+ altri colori + other colours</p>	12 mq	
imbottitura contra back upholstery	 <p><b>MSPT201</b> tessuto intrecciato plaited fabric</p> <p>+ altri colori + other colours</p>	2,5 mtl	
A. bracciolo in essenza lucida armrest in glossy wood	 <p><b>FS01G</b> frassino scuro lucido glossy dark ash wood</p>  <p><b>FS02G</b> frassino chiaro lucido glossy light ash wood</p>		
B. bracciolo in pelle armrest in leather	 <p><b>ET5081</b> pelle leather</p> <p>+ altri colori + other colours</p>	2,5 mq	
composizioni   compositions		Finitura come da immagine. Finish as shown on image.	€ 17.070,00

Altre finiture disponibili su richiesta. | Other finishes available upon request.

## IL CASTAGNO

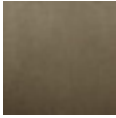
### POLTRONA | ARMCHAIR

quantità | quantity      prezzo | price

cuscini   cushions					
<p>cuscino strutturale 50x50 cm x 1pz structural cushion 50x50 cm x 1 pc</p>	 <p>+ altri colori + other colours</p>	<p><b>NK2132</b> pelle nabuk nubuck leather</p>	1,5 mq	€	<b>320,00</b>
<p>cuscino decorativo A 50x50 cm x 1pz decorative cushion A 50x50 cm x 1 pc</p>	 <p>+ altri colori + other colours</p>	<p><b>MSPT201</b> tessuto intrecciato plaited fabric</p>	0,6 mtl	€	<b>320,00</b>
<p>cuscino decorativo B 50x50 cm x 1pz decorative cushion B 50x50 cm x 1 pc</p>	 <p>+ altri colori + other colours</p>	<p><b>MSPE701</b> velluto velvet</p>	0,6 mtl	€	<b>240,00</b>
<p>cuscino decorativo C 40x40 cm x 1pz decorative cushion C 40x40 cm x 1 pc</p>	 <p>+ altri colori + other colours</p>	<p><b>MSAN601</b> velluto velvet</p>	0,5 mtl	€	<b>210,00</b>

Altre finiture disponibili su richiesta. | Other finishes available upon request.

## LA MAGNOLIA

### DIVANO TRE POSTI | THREE-SEATER SOFA



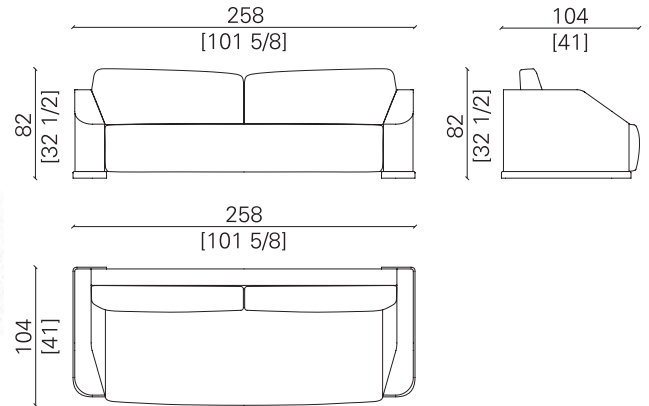

by Fabio Crippa & Joe Gentile

dimensioni | dimensions L258 x P104 x H82 cm  
 peso | weight 80 kg  
 volume | volume 2,80 m<sup>3</sup>

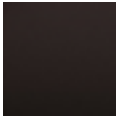

Divano imbottito in velluto con rivestimento braccioli in cuoietto intrecciato, pelle e profilo in cuoietto intrecciato coordinato. Basamento in noce americano tinto scuro in finitura opaca. Imbottitura in poliuretano espanso a densità differenziata con rivestimento in fibra acrilica.

Sofa upholstered in velvet, with armrests upholstered in plaited leatherette, leather, and piping in coordinated colour plaited leatherette. Base in dark matt American walnut. Padding in foam polyurethane of varying density, with acrylic fiber cover.

finiture   finishes		quantità   quantity	prezzo   price
imbottitura upholstery	 <p>+ altri colori + other colours</p> <p><b>LPAL043</b> velluto velvet</p>	<b>9 mtl</b>	
rivestimento braccioli armrest upholstery	 <p>+ altri colori + other colours</p> <p><b>MD03</b> pelle intrecciata plaited leather</p>	<b>1,5 mtl</b>	
profilo intrecciato in pelle plaited leatherette piping		<b>11 mtl</b>	
rivestimento braccioli armrest upholstery	 <p>+ altri colori + other colours</p> <p><b>MDC03</b> cuoio leather</p>	<b>5 mq</b>	
basamento base	 <p><b>NA02</b> noce americano scuro dark American walnut</p>		
composizioni   compositions	Finitura come da immagine. Finish as shown on image.		<b>€ 13.830,00</b>



Altre finiture disponibili su richiesta. | Other finishes available upon request.

## LA MAGNOLIA

### DIVANO TRE POSTI | THREE-SEATER SOFA

quantità | quantity

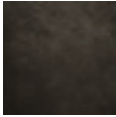
prezzo | price

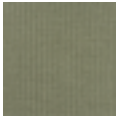
cuscini   cushions					
<p>cuscino strutturale 50x50 cm x 1pz structural cushion 50x50 cm x 1 pc</p>	 <p>+ altri colori + other colours</p>	<p><b>RUOM207</b> velluto velvet</p>	0,6 mtl	€	<b>160,00</b>
<p>cuscino decorativo A 50x50 cm x 1pz decorative cushion A 50x50 cm x 1 pc</p>	 <p>+ altri colori + other colours</p>	<p><b>ET5085</b> pelle leather</p>	0,6 mtl	€	<b>320,00</b>
<p>cuscino decorativo B 50x50 cm x 1pz decorative cushion B 50x50 cm x 1 pc</p>	 <p>+ altri colori + other colours</p>	<p><b>SHSX10</b> tessuto fabric</p>	0,6 mtl	€	<b>210,00</b>
<p>cuscino decorativo C 40x40 cm x 1pz decorative cushion C 40x40 cm x 1 pc</p>	 <p>+ altri colori + other colours</p>	<p><b>SHCS02</b> tessuto fabric</p>	0,5 mtl	€	<b>180,00</b>

Altre finiture disponibili su richiesta. | Other finishes available upon request.

## IL FRASSINO

### DIVANO TRE POSTI | THREE-SEATER SOFA

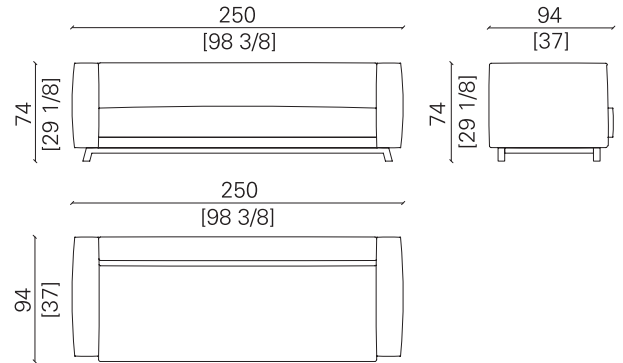

by Fabio Crippa & Joe Gentile

dimensioni   dimensions	L250 x P94 x H74 cm
peso   weight	95 kg
volume   volume	2,30 m <sup>3</sup>

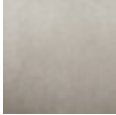
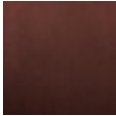

Divano imbottito in nabuk in due colori con cuciture in tinta. Basamento in acciaio inox in finitura cromo nero lucido. Imbottitura in poliuretano espanso a densità differenziata con rivestimento in fibra acrilica e falde in piuma d'oca.

Sofa upholstered in two-tone nubuck leather with matching stitching. Base in shiny black chromed stainless steel. Padding in foam polyurethane of varying density, with acrylic fiber cover and duck's down layers.





finiture   finishes		quantità   quantity	prezzo   price
imbottitura superiore upper upholstery	 <p>+ altri colori + other colours</p> <p><b>NK2101</b> pelle nabuk nubuck leather</p>	20 mq	
imbottitura inferiore lower upholstery	 <p>+ altri colori + other colours</p> <p><b>NK2135</b> pelle nabuk nubuck leather</p>	10 mq	
base in acciaio inox stainless steel base	 <p><b>ME02</b> bagno oro lucido shiny gold plated</p>  <p><b>ME04</b> cromo nero lucido shiny black chrome</p>		
composizioni   compositions	Finitura come da immagine. Finish as shown on image.		€ 13.220,00

Altre finiture disponibili su richiesta. | Other finishes available upon request.

## IL FRASSINO

### DIVANO TRE POSTI | THREE-SEATER SOFA

quantità | quantity      prezzo | price

cuscini   cushions					
<p>cuscino strutturale 50x50 cm x 1pz structural cushion 50x50 cm x 1 pc</p>	<p>Imbottitura cuscini in piuma d'oca. Profilo in tinta o in contrasto. Ducks' down cushion filling. Matching or contrasting piping.</p>		<p>+ altri colori + other colours</p>	<p>1,5 mq</p>	<p>€ 320,00</p>
<p>cuscino decorativo A 50x50 cm x 1pz decorative cushion A 50x50 cm x 1 pc</p>			<p>+ altri colori + other colours</p>	<p>0,6 mtl</p>	<p>€ 170,00</p>
<p>cuscino decorativo B 50x50 cm x 1pz decorative cushion B 50x50 cm x 1 pc</p>			<p>+ altri colori + other colours</p>	<p>0,6 mtl</p>	<p>€ 410,00</p>
<p>cuscino decorativo C 40x40 cm x 1pz decorative cushion C 40x40 cm x 1 pc</p>			<p>+ altri colori + other colours</p>	<p>0,5 mtl</p>	<p>€ 200,00</p>

Altre finiture disponibili su richiesta. | Other finishes available upon request.

## IL FRASSINO

### POLTRONA | ARMCHAIR

by Fabio Crippa & Joe Gentile

dimensioni | dimensions L110 x P94 x H74 cm  
 peso | weight 58 kg  
 volume | volume 1,05 m<sup>3</sup>

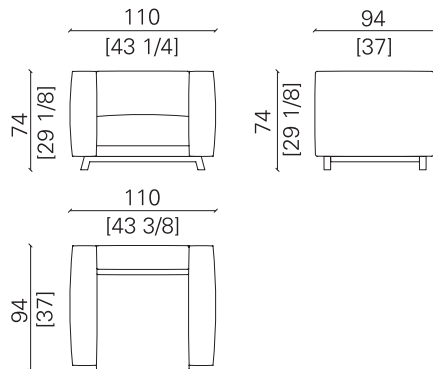

Poltrona imbottita in nabuk in due colori con cuciture in tinta. Basamento in acciaio inox in finitura cromo nero lucido. Imbottitura in poliuretano espanso a densità differenziata con rivestimento in fibra acrilica e falde in piuma d'oca.

Armchair upholstered in two-tone nubuck leather with matching stitching. Base in shiny black chromed stainless steel. Padding in foam polyurethane of varying density, with acrylic fiber cover and duck's down layers.

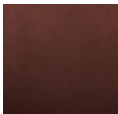
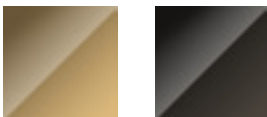
finiture   finishes		quantità   quantity	prezzo   price
imbottitura superiore upper upholstery	 <p>+ altri colori + other colours</p> <p><b>NK2101</b> pelle nabuk nubuck leather</p>	10 mq	
imbottitura inferiore lower upholstery	 <p>+ altri colori + other colours</p> <p><b>NK2135</b> pelle nabuk nubuck leather</p>	5 mq	
base in acciaio inox stainless steel base	 <p><b>ME02</b> bagno oro lucido shiny gold plated</p> <p><b>ME04</b> cromo nero lucido shiny black chrome</p>		
composizioni   compositions	Finitura come da immagine. Finish as shown on image.		€ 7.400,00



Altre finiture disponibili su richiesta. | Other finishes available upon request.



## IL FRASSINO

### POLTRONA | ARMCHAIR

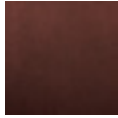
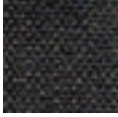
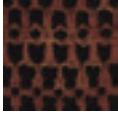
quantità | quantity      prezzo | price

cuscini   cushions		Imbottitura cuscini in piuma d'oca. Profilo in tinta o in contrasto. Ducks' down cushion filling. Matching or contrasting piping.				
cuscino strutturale 50x50 cm x 1pz structural cushion 50x50 cm x 1 pc	 <b>NK2101</b> pelle nabuk nubuck leather	 <b>NK2135</b> pelle nabuk nubuck leather	+ altri colori + other colours	1,5 mq	€	<b>320,00</b>
cuscino decorativo A 50x50 cm x 1pz decorative cushion A 50x50 cm x 1 pc	 <b>ELNB880</b> tessuto fabric		+ altri colori + other colours	0,6 mtl	€	<b>170,00</b>
cuscino decorativo B 50x50 cm x 1pz decorative cushion B 50x50 cm x 1 pc	 <b>KHMR004</b> tessuto fabric		+ altri colori + other colours	0,6 mtl	€	<b>410,00</b>
cuscino decorativo C 40x40 cm x 1pz decorative cushion C 40x40 cm x 1 pc	 <b>NBVP53</b> velluto velvet		+ altri colori + other colours	0,5 mtl	€	<b>200,00</b>

Altre finiture disponibili su richiesta. | Other finishes available upon request.

## IL TIGLIO

### DIVANO TRE POSTI | THREE-SEATER SOFA

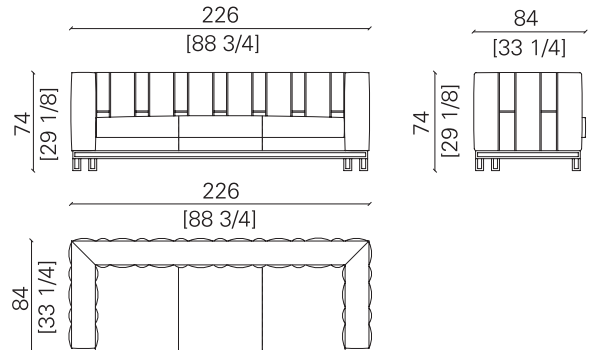

by Fabio Crippa & Joe Gentile

dimensioni | dimensions L226 x P84 x H74 cm  
 peso | weight 110 kg  
 volume | volume 1,90 m<sup>3</sup>

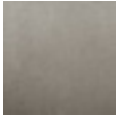
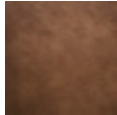

Divano imbottito in pelle nabuk con cuciture ricamate a trapuntatura verticale. Basamento in acciaio inox in finitura bagno oro lucido. Imbottitura in poliuretano espanso a densità differenziata con rivestimento in fibra acrilica.

Sofa upholstered in nubuck leather, with vertical quilted stitching. Base in shiny gold plated stainless steel. Padding in foam polyurethane of varying density, with acrylic fiber cover.

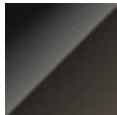

finiture   finishes	quantità   quantity	prezzo   price
imbottitura upholstery	<div style="display: flex; justify-content: space-around;"> <div style="text-align: center;">   <b>NK2118</b>                      pelle nabuk                      nubuck leather                 </div> <div style="text-align: center;">   <b>ET5081</b>                      pelle                      leather                 </div> </div> <p>+ altri colori + other colours</p>	<b>25 mq</b>
base in acciaio inox stainless steel base	<div style="display: flex; justify-content: space-around;"> <div style="text-align: center;">   <b>ME02</b>                      bagno oro                      lucido                      shiny gold                      plated                 </div> <div style="text-align: center;">   <b>ME04</b>                      cromo nero                      lucido                      shiny black                      chrome                 </div> </div>	
composizioni   compositions	Finitura come da immagine. Finish as shown on image.	<b>€ 15.760,00</b>

Altre finiture disponibili su richiesta. | Other finishes available upon request.

## IL TIGLIO

### DIVANO TRE POSTI | THREE-SEATER SOFA

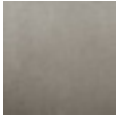
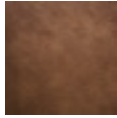
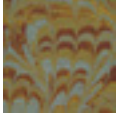
quantità | quantity      prezzo | price

cuscini   cushions					
<p>cuscini strutturali 50x50 cm x 1pz structural cushions 50x50 cm x 1 pc</p>	<p>Imbottitura cuscini in piuma d'oca. Profilo in tinta o in contrasto. Ducks' down cushion filling. Matching or contrasting piping.</p>	 	<p>+ altri colori + other colours</p>	<p>1,5 mq</p>	<p>€ 320,00</p>
<p>cuscino decorativo A 50x50 cm x 1pz decorative cushion A 50x50 cm x 1 pc</p>			<p>+ altri colori + other colours</p>	<p>0,6 mtl</p>	<p>€ 200,00</p>
<p>cuscino decorativo B 50x50 cm x 1pz decorative cushion B 50x50 cm x 1 pc</p>			<p>+ altri colori + other colours</p>	<p>0,6 mtl</p>	<p>€ 170,00</p>
<p>cuscino decorativo C 40x40 cm x 1pz decorative cushion C 40x40 cm x 1 pc</p>			<p>+ altri colori + other colours</p>	<p>0,5 mtl</p>	<p>€ 170,00</p>
		<p><b>NK2118</b> pelle nabuk nubuck leather</p>	<p><b>ET5081</b> pelle leather</p>		
		<p><b>RUPV004</b> tessuto fabric</p>			
		<p><b>ZFHS900</b> tessuto fabric</p>			
		<p><b>LPLL018</b> tessuto fabric</p>			

Altre finiture disponibili su richiesta. | Other finishes available upon request.

## IL TIGLIO

### POLTRONA | ARMCHAIR

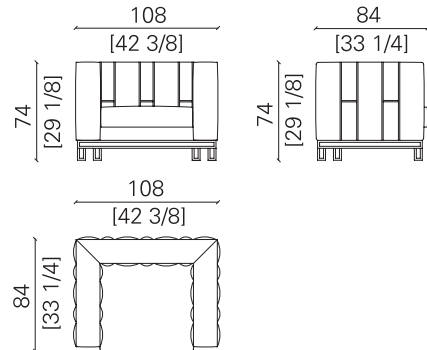

by Fabio Crippa & Joe Gentile

dimensioni   dimensions	L108 x P84 x H74 cm
peso   weight	68 kg
volume   volume	1,00 m <sup>3</sup>



Poltrona imbottita in pelle nabuk con cuciture ricamate a trapuntatura verticale. Basamento in acciaio inox in finitura bagno oro lucido. Imbottitura in poliuretano espanso a densità differenziata con rivestimento in fibra acrilica.

Armchair upholstered in nubuck leather, with vertical quilted stitching. Base in shiny gold plated stainless steel. Padding in foam polyurethane of varying density, with acrylic fiber cover.



finiture   finishes	quantità   quantity	prezzo   price
imbottitura upholstery	 + altri colori + other colours	14 mq
base in acciaio inox stainless steel base		
composizioni   compositions	Finitura come da immagine. Finish as shown on image.	€ 9.310,00

Altre finiture disponibili su richiesta. | Other finishes available upon request.

## IL TIGLIO

### POLTRONA | ARMCHAIR

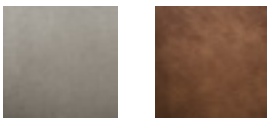
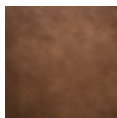
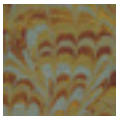
quantità | quantity      prezzo | price

cuscini   cushions		Imbottitura cuscini in piuma d'oca. Profilo in tinta o in contrasto. Ducks' down cushion filling. Matching or contrasting piping.				
cuscini strutturali 50x50 cm x 1pz structural cushions 50x50 cm x 1 pc	 <b>NK2118</b> pelle nabuk nubuck leather	 <b>ET5081</b> pelle leather	+ altri colori + other colours	1,5 mq	€	<b>320,00</b>
cuscino decorativo A 50x50 cm x 1pz decorative cushion A 50x50 cm x 1 pc	 <b>RUPV004</b> tessuto fabric		+ altri colori + other colours	0,6 mtl	€	<b>200,00</b>
cuscino decorativo B 50x50 cm x 1pz decorative cushion B 50x50 cm x 1 pc	 <b>ZFHS900</b> tessuto fabric		+ altri colori + other colours	0,6 mtl	€	<b>170,00</b>
cuscino decorativo C 40x40 cm x 1pz decorative cushion C 40x40 cm x 1 pc	 <b>LPLL018</b> tessuto fabric		+ altri colori + other colours	0,5 mtl	€	<b>170,00</b>

Altre finiture disponibili su richiesta. | Other finishes available upon request.

# LA BETULLA

## POLTRONA | ARMCHAIR



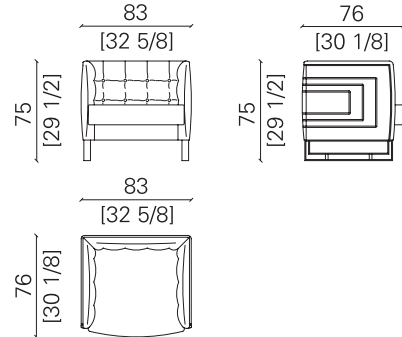

by Fabio Crippa & Joe Gentile

dimensioni | dimensions L83 x P76 x H75 cm  
 peso | weight 110 kg  
 volume | volume 0,70 m<sup>3</sup>

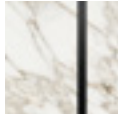
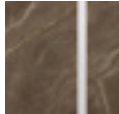
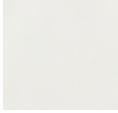

Poltrona con struttura in marmo Nero Marquina con inserti in marmo in contrasto, imbottitura interna in pelle con lavorazione schienale in capitonnè eseguita a mano. Basamento in ottone in finitura cromo nero lucido. Imbottitura in poliuretano espanso a densità differenziata con rivestimento in fibra acrilica.

Armchair with Nero Marquina marble structure and contrasting marble inserts, upholstered internally in leather, with hand-crafted capitonnè backrest. Base in shiny black chromed brass. Padding in foam polyurethane of varying density, with acrylic fiber cover.

finiture   finishes		quantità   quantity	prezzo   price
struttura in marmo con inserto in contrasto marble structure with contrasting inserts	<div style="display: flex; justify-content: space-around;"> <div style="text-align: center;">   <b>MA.N01</b>                      Nero Marquina con inserto bianco                      with white insert                 </div> <div style="text-align: center;">   <b>MA.B01</b>                      Calacatta Vagli Oro con inserto nero                      with black insert                 </div> <div style="text-align: center;">   <b>MA.T02</b>                      Bronze Amani con inserto bianco                      with white insert                 </div> </div>		
seduta imbottita in pelle seat upholstered in leather	<div style="display: flex; align-items: center;">  <div>                     + altri colori                      + other colours                 </div> </div> <p><b>ZF1870</b> pelle leather</p>	<b>10 mq</b>	
basamento in ottone base in brass	<div style="display: flex; justify-content: space-around;"> <div style="text-align: center;">   <b>ME01</b>                      bronzato                      bronzed                 </div> <div style="text-align: center;">   <b>ME02</b>                      bagno oro lucido                      shiny gold plated                 </div> <div style="text-align: center;">   <b>ME03</b>                      satinato                      satin finish                 </div> <div style="text-align: center;">   <b>ME04</b>                      cromo nero lucido                      shiny black chrome                 </div> </div>		
composizioni   compositions	Finitura come da immagine. Finish as shown on image.	<b>€ 17.500,00</b>	

Altre finiture disponibili su richiesta. | Other finishes available upon request.

# LA BETULLA

POLTRONA | ARMCHAIR

quantità | quantity

prezzo | price

cuscini | cushions

cuscino strutturale  
50x50 cm x 1pz  
structural cushion  
50x50 cm x 1 pc

Imbottitura cuscini in piuma d'oca. Profilo in tinta o in contrasto.  
Ducks' down cushion filling. Matching or contrasting piping.

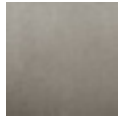

+ altri colori  
+ other colours

**ZF1870**  
pelle  
leather

1,5 mq

€ 250,00

## L'AGRIFOGLIO

### POLTRONCINA LOUNGE VARIANTE 1 | LOUNGE ARMCHAIR VARIANT 1



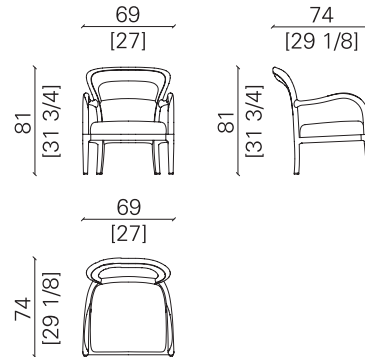

by Fabio Crippa & Joe Gentile

dimensioni | dimensions L69 x P74 x H81 cm  
 peso | weight 11 kg  
 volume | volume 0,60 m<sup>3</sup>

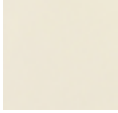

Poltroncina in massello di noce americano tinto scuro opaco. Imbottitura schienale, internamente gambe posteriori, seduta e profilo in pelle con cuciture in tinta. Bracciolo in massello di noce americano tinto scuro opaco con inserto in pelle con cucitura in tinta. Puntalini in ottone in finitura satinata.

Armchair in dark solid American walnut in matt finishing. Backrest, rear legs inner part, seat and profile upholstered in leather with matching stitching. Armrest in dark matt solid American walnut, with inlay in leather with matching stitching. Tips in satin finish brass.

finiture   finishes		quantità   quantity	prezzo   price
struttura in noce americano opaco matt American walnut structure	<div style="display: flex; justify-content: space-around;"> <div style="text-align: center;">   <b>NA01</b>                      noce amer. scuro opaco                      matt dark                      American walnut                 </div> <div style="text-align: center;">   <b>NA02</b>                      noce amer. naturale opaco                      matt natural                      American walnut                 </div> </div>		
imbottitura in pelle leather upholstery	<div style="text-align: center;">   <b>ZF1634</b>                      pelle                      leather                 </div> <p style="text-align: center;">+ altri colori + other colours</p>	<b>4 mq</b>	
puntalini in ottone brass tips	<div style="display: flex; justify-content: space-around;"> <div style="text-align: center;">   <b>ME02</b>                      bagno oro lucido                      shiny gold plated                 </div> <div style="text-align: center;">   <b>ME03</b>                      satinato                      satin finish                 </div> </div>		
composizioni   compositions	Finitura come da immagine. Finish as shown on image.	<b>€ 6.370,00</b>	

Altre finiture disponibili su richiesta. | Other finishes available upon request.



# L'AGRIFOGLIO

## POLTRONCINA LOUNGE VARIANTE 1 | LOUNGE ARMCHAIR VARIANT 1

quantità | quantity

prezzo | price

cuscini | cushions

cuscino decorativo  
20x40 cm x 1pz  
decorative cushion  
20x40 cm x 1 pc

Imbottitura cuscini in piuma d'oca. Profilo in tinta o in contrasto.  
Ducks' down cushion filling. Matching or contrasting piping.

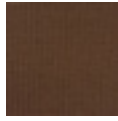

+ altri colori  
+ other colours

**SHCS03**  
tessuto  
fabric

0,5 mtl

€ 190,00

Altre finiture disponibili su richiesta. | Other finishes available upon request.

## L'AGRIFOGLIO

### POLTRONCINA LOUNGE VARIANTE 2 | LOUNGE ARMCHAIR VARIANT 2



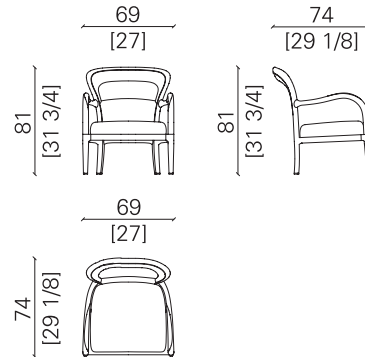

by Fabio Crippa & Joe Gentile

dimensioni | dimensions L69 x P74 x H81 cm  
 peso | weight 11 kg  
 volume | volume 0,60 m<sup>3</sup>

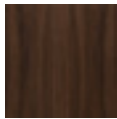

Poltroncina in massello di noce americano tinto scuro opaco. Imbottitura schienale, internamente gambe posteriori, seduta e profilo in pelle con cuciture in tinta. Bracciolo in massello di noce americano tinto scuro opaco con inserto in pelle con cucitura in tinta. Puntalini in ottone in finitura satinata.

Armchair in dark solid American walnut in matt finishing. Backrest, rear legs inner part, seat and profile upholstered in leather with matching stitching. Armrest in dark matt solid American walnut, with inlay in leather with matching stitching. Tips in satin finish brass.

finiture   finishes		quantità   quantity	prezzo   price
struttura in noce americano opaco matt American walnut structure	 <p><b>NA01</b> noce amer. scuro opaco matt dark American walnut</p>		
	 <p><b>NA02</b> noce amer. naturale opaco matt natural American walnut</p>		
profilo intrecciato in cuoietto plaited leatherette piping		5 mtl	
imbottitura in pelle leather upholstery	 <p>+ altri colori + other colours</p> <p><b>ZF1124</b> pelle leather</p>	4 mq	
puntalini in ottone brass tips	 <p><b>ME02</b> bagno oro lucido shiny gold plated</p>		
	 <p><b>ME03</b> satinato satin finish</p>		
composizioni   compositions	Finitura come da immagine. Finish as shown on image.		€ 6.220,00

Altre finiture disponibili su richiesta. | Other finishes available upon request.

## L'AGRIFOGLIO

### POLTRONCINA LOUNGE VARIANTE 2 | LOUNGE ARMCHAIR VARIANT 2

quantità | quantity

prezzo | price

cuscini | cushions

cuscinio decorativo  
20x40 cm x 1pz  
decorative cushion  
20x40 cm x 1 pc

Imbottitura cuscini in piuma d'oca. Profilo in tinta o in contrasto.  
Ducks' down cushion filling. Matching or contrasting piping.

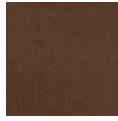

+ altri colori  
+ other colours

**SHCS03**  
tessuto  
fabric

0,5 mtl

€ 190,00

Altre finiture disponibili su richiesta. | Other finishes available upon request.

# L'AGRIFOGLIO

## DIVANETTO VARIANTE 1 | LOVESEAT VARIANT 1

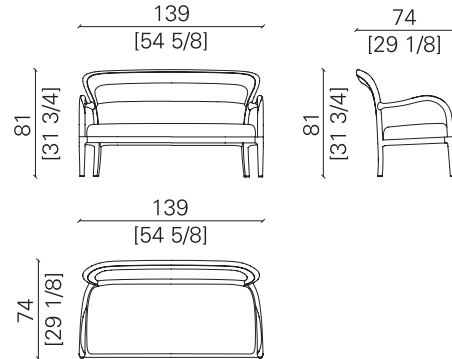

by Fabio Crippa & Joe Gentile

dimensioni | dimensions L139 x P74 x H81 cm  
 peso | weight 20 kg  
 volume | volume 1,15 m<sup>3</sup>

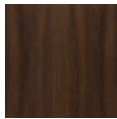
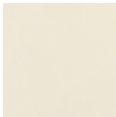

Divanetto in massello di noce americano tinto scuro opaco. Imbottitura schienale, internamente gambe posteriori, seduta e profilo in pelle con cuciture in tinta. Bracciolo in massello di noce americano tinto scuro opaco con inserto in pelle con cucitura in tinta. Puntalini in ottone in finitura satinata.

Loveseat in dark solid American walnut in matt finishing. Backrest, rear legs inner part, seat and profile upholstered in leather with matching stitching. Armrest in dark matt solid American walnut, with inlay in leather with matching stitching. Tips in satin finish brass.

finiture   finishes		quantità   quantity	prezzo   price
struttura in noce americano opaco matt American walnut structure	<div style="display: flex; justify-content: space-around;"> <div style="text-align: center;">  <p><b>NA01</b> noce amer. scuro opaco matt dark American walnut</p> </div> <div style="text-align: center;">  <p><b>NA02</b> noce amer. naturale opaco matt natural American walnut</p> </div> </div>		
imbottitura in pelle leather upholstery	<div style="text-align: center;">  <p><b>ZF1634</b> pelle leather</p> </div> <p>+ altri colori + other colours</p>	<b>6 mq</b>	
puntalini in ottone brass tips	<div style="display: flex; justify-content: space-around;"> <div style="text-align: center;">  <p><b>ME02</b> bagno oro lucido shiny gold plated</p> </div> <div style="text-align: center;">  <p><b>ME03</b> satinato satin finish</p> </div> </div>		
composizioni   compositions		Finitura come da immagine. Finish as shown on image.	<b>€ 9.300,00</b>

Altre finiture disponibili su richiesta. | Other finishes available upon request.

# L'AGRIFOGLIO

## DIVANETTO VARIANTE 1 | LOVESEAT VARIANT 1

quantità | quantity      prezzo | price

cuscini | cushions

cuscino decorativo  
20x55 cm x 1pz  
decorative cushion  
20x55 cm x 1 pc

Imbottitura cuscini in piuma d'oca. Profilo in tinta o in contrasto.  
Ducks' down cushion filling. Matching or contrasting piping.

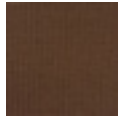

+ altri colori  
+ other colours

**SHCS03**  
tessuto  
fabric

0,5 mtl      €      **190,00**

# L'AGRIFOGLIO

## DIVANETTO VARIANTE 2 | LOVESEAT VARIANT 2



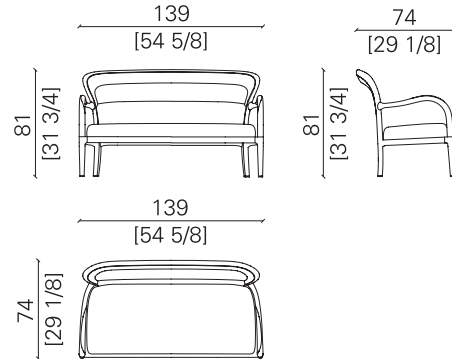

by Fabio Crippa & Joe Gentile

dimensioni | dimensions L139 x P74 x H81 cm  
 peso | weight 20 kg  
 volume | volume 1,15 m<sup>3</sup>

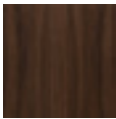

Divanetto in massello di noce americano tinto scuro opaco. Imbottitura schienale, internamente gambe posteriori, seduta e profilo in pelle con cuciture in tinta. Bracciolo in massello di noce americano tinto scuro opaco con inserto in pelle con cucitura in tinta. Puntalini in ottone in finitura satinata.

Loveseat in dark solid American walnut in matt finishing. Backrest, rear legs inner part, seat and profile upholstered in leather with matching stitching. Armrest in dark matt solid American walnut, with inlay in leather with matching stitching. Tips in satin finish brass.

finiture   finishes		quantità   quantity	prezzo   price
struttura in noce americano opaco matt American walnut structure	 <b>NA01</b> noce amer. scuro opaco matt dark American walnut  <b>NA02</b> noce amer. naturale opaco matt natural American walnut		
profilo intrecciato in cuoietto plaited leatherette piping		6,5 mtl	
imbottitura in pelle leather upholstery	 + altri colori + other colours <b>ZF1124</b> pelle leather	6 mq	
puntalini in ottone brass tips	 <b>ME02</b> bagno oro lucido shiny gold plated  <b>ME03</b> satinato satin finish		
composizioni   compositions	Finitura come da immagine. Finish as shown on image.		€ 8.820,00

Altre finiture disponibili su richiesta. | Other finishes available upon request.

## L'AGRIFOGLIO

### DIVANETTO VARIANTE 2 | LOVESEAT VARIANT 2

quantità | quantity      prezzo | price

cuscini | cushions

cuscino decorativo  
20x55 cm x 1pz  
decorative cushion  
20x55 cm x 1 pc

Imbottitura cuscini in piuma d'oca. Profilo in tinta o in contrasto.  
Ducks' down cushion filling. Matching or contrasting piping.

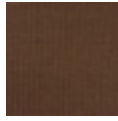

+ altri colori  
+ other colours





**SHCS03**  
tessuto  
fabric

0,5 mtl      €      190,00

## CUSCINI · CUSHIONS

### CUSCINI DECORATIVI | DECORATIVE CUSHIONS

misure | measures    quantità | quantity    prezzo | price

cuscini   cushions		Imbottitura cuscini in piuma d'oca. Profilo in tinta o in contrasto. Ducks' down cushion filling. Matching or contrasting piping.			
CU_01		1 x 50x50 cm	0,6 mtl	€	530,00
		1 x 40x40 cm	0,5 mtl	€	455,00
CU_02		1 x 50x50 cm	0,6 mtl	€	325,00
		1 x 40x40 cm	0,5 mtl	€	285,00
CU_03		1 x 50x50 cm	0,6 mtl	€	280,00
		1 x 40x40 cm	0,5 mtl	€	245,00
CU_04		1 x 50x50 cm	0,6 mtl	€	280,00
		1 x 40x40 cm	0,5 mtl	€	245,00
CU_05		1 x 50x50 cm	0,6 mtl	€	420,00
		1 x 40x40 cm	0,5 mtl	€	360,00

Altre finiture disponibili su richiesta. | Other finishes available upon request.





# IL MIRTO

## MOBILE BAR VARIANTE 1 | BAR CABINET VARIANT 1

by Fabio Crippa & Joe Gentile

dimensioni | dimensions  
peso | weight  
volume | volume

L116 x P61 x H195 cm  
280 kg  
1,85 m<sup>3</sup>

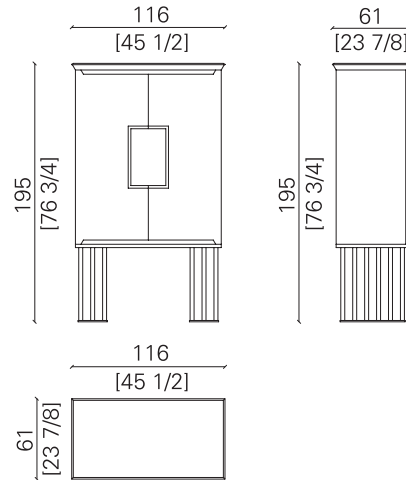

Mobile bar con struttura in multistrato di pioppo, esterno in finitura eucalipto frisè lucido color rosso marsala, ante fronte/retro con intarsio a righe in contrasto. Schienale nicchia in pietra semipreziosa Ferro Tigrato. Basamento, decorazioni, rivestimento nicchia e maniglie in ottone in finitura bagno oro lucido. Finitura interna in laccato lucido, schienale in specchio bronzato e ripiani in vetro bronzato temperato. Tappetini e fondo cassetti in cuoietto in tinta con cuciture a contrasto. Illuminazione interna a LED.

Bar cabinet with multi-ply poplar structure, glossy marsala red frisè eucalyptus external finish, with doors inlaid with contrasting strips on both sides. Niche back panel in Tiger Iron semi-precious stone. Base, decorations, niche cladding and handles in shiny gold plated brass. Glossy lacquered internal finish, bronzed mirror back panel, and shelves in bronzed tempered glass. Mats and drawer bottoms in matching leatherette with contrasting stitching. LED internal lighting.

### finiture | finishes

**A.** rivestimento ante in eucalipto frisè lucido con intarsio a righe in contrasto  
door cladding in glossy frisè eucalyptus, with contrasting inlaid strips

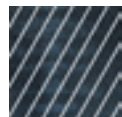

**EF101.G**  
eucalipto frisè col. blu cobalto  
frisè eucalyptus cobalt blue colour

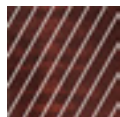

**EF102.G**  
eucalipto frisè col. rosso marsala  
frisè eucalyptus marsala red colour

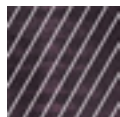

**EF103.G**  
eucalipto frisè col. ametista  
frisè eucalyptus amethyst colour

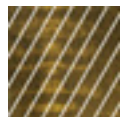

**EF104.G**  
eucalipto frisè col. giallo ocre  
frisè eucalyptus ocher yellow colour

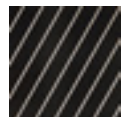

**EF105.G**  
eucalipto frisè col. nero  
frisè eucalyptus black colour

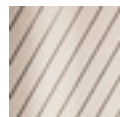

**EF106.G**  
eucalipto frisè col. avorio  
frisè eucalyptus ivory colour

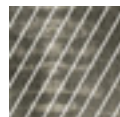

**EF107.G**  
eucalipto frisè col. tortora  
frisè eucalyptus dove grey colour

**B.** rivestimento ante in eucalipto frisè lucido  
door cladding in glossy frisè eucalyptus



**EF01.G**  
eucalipto col. blu cobalto  
eucalyptus cobalt blue colour



**EF02.G**  
eucalipto col. rosso marsala  
eucalyptus marsala red colour



**EF03.G**  
eucalipto col. ametista  
eucalyptus amethyst colour



**EF04.G**  
eucalipto col. giallo ocre  
eucalyptus ocher yellow colour



**EF05.G**  
eucalipto col. nero  
eucalyptus black colour



**EF06.G**  
eucalipto col. avorio  
eucalyptus ivory colour

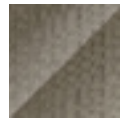

**EF07.G**  
eucalipto col. tortora  
eucalyptus dove grey colour

schienale nicchia in pietra semipreziosa  
niche back panel in semi-precious stone



**PS01**  
Labradorite

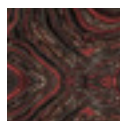

**PS02**  
Ferro Tigrato  
Tiger Iron



**PS03**  
Ametista  
Amethyst

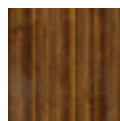

**PS04**  
Occhio di Tigre  
Tiger's Eye

Altre finiture disponibili su richiesta. | Other finishes available upon request.

# IL MIRTO

## MOBILE BAR VARIANTE 1 | BAR CABINET VARIANT 1

prezzo | price

### finiture | finishes

basamento, rivestimento nicchia e maniglie in ottone base, niche lining, and handles in brass



**ME01**  
bronzato  
bronzed



**ME02**  
bagno oro lucido  
shiny gold plated



**ME03**  
satinato  
satin finish



**ME04**  
cromo nero lucido  
shiny black chrome

finitura interna in laccato lucido glossy lacquered internal finish



**LA05.G**  
laccato lucido col. nero  
glossy lacquered black colour



**LA06.G**  
laccato lucido col. avorio  
glossy lacquered ivory colour



**LA07.G**  
laccato lucido col. tortora  
glossy lacquered dove grey colour

tappetini decorativi e fondo cassetti in cuoietto con cucitura in contrasto decorative mats and drawer bottoms in leatherette with contrasting stitching

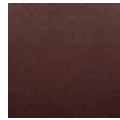

**CU07**  
col. rosso marsala  
marsala red colour

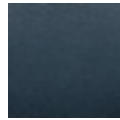

**CU06**  
col. blu cobalto  
cobalto blue colour



**CU04**  
col. nero  
black colour

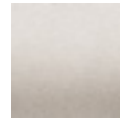

**CU01**  
col. avorio  
ivory colour



**CU02**  
col. tortora  
dove grey colour

schienale in specchio mirror back panel



**SP01**  
specchio naturale  
natural mirror



**SP02**  
specchio bronzato  
bronzed mirror



**SP03**  
specchio fumé  
smoked mirror

ripiani in vetro glass shelves



**VE01**  
vetro extrach.  
extra-clear glass



**VE02**  
vetro bronzato  
bronzed glass



**VE03**  
vetro fumé  
smoked glass

### composizioni | compositions

**A.** Mobile bar con rivestimento ante in eucalipto frisè lucido con intarsi in contrasto e schienale nicchia in pietra semipreziosa.  
Bar cabinet with door cladding in glossy frisè eucalyptus, with contrasting inlays and niche back panel in semi-precious stone.

€ 34.660,00

Mobile bar con rivestimento ante e schienale nicchia in eucalipto frisè lucido con intarsi in contrasto.  
Bar cabinet with door cladding and niche back panel in glossy frisè eucalyptus, with contrasting inlays.

€ 30.640,00

**B.** Mobile bar con rivestimento ante in eucalipto frisè e schienale nicchia in pietra semipreziosa.  
Bar cabinet with door cladding in frisè eucalyptus and niche back panel in semi-precious stone.

€ 32.910,00

Mobile bar con rivestimento ante e schienale nicchia in eucalipto frisè lucido.  
Bar cabinet with door cladding and niche back panel in glossy frisè eucalyptus.

€ 28.890,00

Altre finiture disponibili su richiesta. | Other finishes available upon request.

# IL MIRTO

## MOBILE BAR VARIANTE 2 | BAR CABINET VARIANT 2

by Fabio Crippa & Joe Gentile

dimensioni | dimensions L116 x P61 x H195 cm  
 peso | weight 280 kg  
 volume | volume 1,85 m<sup>3</sup>

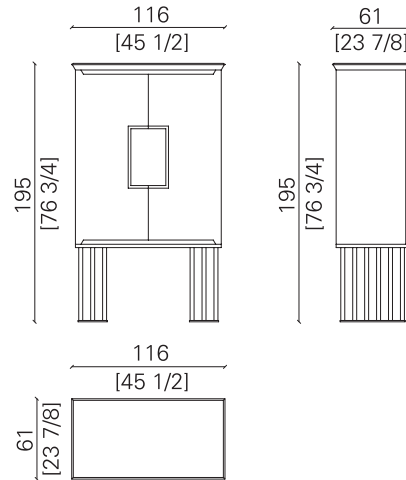

Mobile bar con struttura in multistrato di pioppo, esterno in finitura noce americano naturale lucido. Ante con intarsio in lastra di noce americano naturale lucido. Schienale nicchia in pietra semipreziosa Labradorite. Basamento, decorazioni, rivestimento nicchia e maniglie in ottone in finitura bronzata. Finitura interna in laccato lucido, schienale in specchio bronzato e ripiani in vetro bronzato temperato. Tappetini e fondo cassetti in cuoietto in tinta con cuciture a contrasto. Illuminazione interna a LED.

Bar cabinet with multy-ply poplar structure, external finish in glossy natural American walnut. Doors with inlays in glossy natural American walnut panels. Niche back panel in semi-precious Labradorite stone. Base, decorations, niche lining, and handles in bronze finished brass. Glossy lacquered internal finish, bronzed mirror backing, and shelves in bronzed tempered glass. Mats and drawer bottoms in matching leatherette with contrasting stitching. LED internal lighting.

### finiture | finishes

**A.** finitura in essenza di legno lucida  
 glossy wood finish



**PL01.G**  
 palissandro scuro lucido  
 glossy dark rosewood



**NA01.G**  
 noce amer. scuro lucido  
 glossy dark American walnut



**NA02.G**  
 noce amer. naturale lucido  
 glossy natural American walnut



**ZB01.G**  
 zebrano lucido  
 glossy zebrawood

**B.** finitura in essenza di legno opaca  
 matt wood finish



**PL01.M**  
 palissandro scuro opaco  
 matt dark rosewood



**NA01.M**  
 noce amer. scuro opaco  
 matt dark American walnut



**NA02.L.M**  
 noce amer. naturale opaco  
 matt natural American walnut

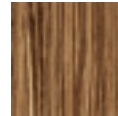

**ZB01.M**  
 zebrano opaco  
 matt zebrawood

schienale nicchia in pietra semipreziosa  
 niche back panel in semi-precious stone



**PS01**  
 Labradorite

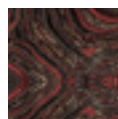

**PS02**  
 Ferro Tigrato  
 Tiger Iron



**PS03**  
 Ametista  
 Amethyst



**PS04**  
 Occhio di Tigre  
 Tiger's Eye

Altre finiture disponibili su richiesta. | Other finishes available upon request.

## IL MIRTO

### MOBILE BAR VARIANTE 2 | BAR CABINET VARIANT 2

prezzo | price

#### finiture | finishes

basamento, rivestimento nicchia e maniglie in ottone  
base, niche lining, and handles in brass



**ME01**  
bronzato  
bronzed



**ME02**  
bagno oro lucido  
shiny gold plated



**ME03**  
satinato  
satin finish



**ME04**  
cromo nero lucido  
shiny black chrome

finitura interna in laccato lucido  
glossy lacquered internal finish



**LA06.G**  
laccato lucido  
col. avorio  
glossy lacquered  
ivory colour



**LA07.G**  
laccato lucido  
col. tortora  
glossy lacquered  
dove grey colour



**LA05.G**  
laccato lucido  
col. nero  
glossy lacquered  
black colour

tappetini decorativi e fondo cassetti in cuoietto con cucitura in contrasto  
decorative mats and drawer bottoms in leatherette with contrasting stitching



**CU01**  
col. avorio  
ivory colour



**CU02**  
col. tortora  
dove grey colour



**CU04**  
col. nero  
black colour

schienale in specchio  
mirror back panel



**SP01**  
specchio naturale  
natural mirror



**SP02**  
specchio bronzato  
bronzed mirror



**SP03**  
specchio fumé  
smoked mirror

ripiani in vetro  
glass shelves



**VE01**  
vetro extrach.  
extra-clear  
glass



**VE02**  
vetro bronzato  
bronzed glass



**VE03**  
vetro fumé  
smoked glass

#### composizioni | compositions

**A.** Mobile bar con rivestimento ante in essenza di legno lucida a scelta e schienale nicchia in pietra semipreziosa.  
Bar cabinet with door cladding in choice of glossy wood finishes and niche back panel in semi-precious stone. **€ 33.610,00**

Mobile bar con rivestimento ante e schienale nicchia in essenza di legno lucida a scelta.  
Bar cabinet with door cladding and niche back panel in choice of glossy wood finishes. **€ 29.590,00**

**B.** Mobile bar con rivestimento ante in essenza di legno opaca a scelta e schienale nicchia in pietra semipreziosa.  
Bar cabinet with door cladding in choice of matt wood finishes and niche back panel in semi-precious stone. **€ 30.810,00**

Mobile bar con rivestimento ante e schienale nicchia in essenza di legno opaca a scelta.  
Bar cabinet with door cladding and niche back panel in choice of matt wood finishes. **€ 26.790,00**

Altre finiture disponibili su richiesta. | Other finishes available upon request.

## IL GINEPRO

### MOBILE BAR | BAR CABINET

by Fabio Crippa & Joe Gentile

dimensioni | dimensions  
peso | weight  
volume | volume

L90 x P52 x H177 cm  
108 kg  
1,16 m<sup>3</sup>

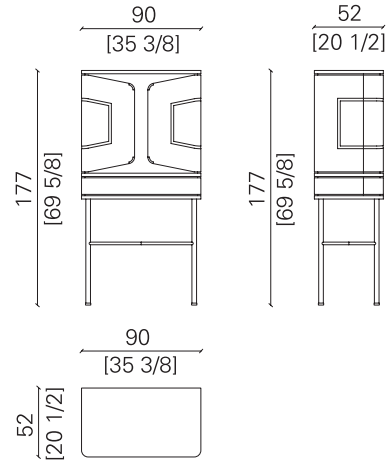

Mobile bar con struttura in multistrato di pioppo. Finitura esterna rivestita in pergamena lucida con decorazione fresata. Finitura interna in laccato lucido e radica amboina in finitura lucida. Divisorio in vetro trasparente con decorazione a rombi. Basamento e dettagli in ottone in finitura cromo nero lucido. Fondo cassetto in cuoietto in tinta. Illuminazione interna a LED.

Bar cabinet with multi-ply poplar structure. External finish in glossy parchment cladding, with milled decoration. Internal finish in glossy lacquering and glossy amboina briar. Divider in transparent glass, with diamond decoration. Base and details in shiny black chromed brass. Drawer bottom in matching leatherette. LED internal lighting.

#### finiture | finishes

**A.** rivestimento ante in pergamena lucida  
door cladding in glossy parchment



**PE07.G**  
pergamena lucida col. tabacco  
glossy parchment tobacco colour



**PES02.G**  
pergamena lucida col. verde oceano  
glossy parchment ocean green colour

**B.** rivestimento ante in laccato lucido  
door cladding glossy lacquered



**LA06.G**  
laccato lucido col. avorio  
glossy lacquered ivory colour

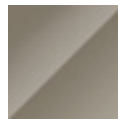

**LA07.G**  
laccato lucido col. tortora  
glossy lacquered dove grey colour

finitura interna in essenza di legno lucida  
internal finish in glossy wood



**RA03.G**  
radica amboina  
amboina briar



**CB01.G**  
carbalho col. oceano  
carbalho ocean colour

Altre finiture disponibili su richiesta. | Other finishes available upon request.

## IL GINEPRO

### MOBILE BAR | BAR CABINET

prezzo | price

#### finiture | finishes

finitura interna in laccato lucido  
glossy lacquered internal finish



**LA06.G**  
laccato lucido  
col. avorio  
glossy lacquered  
ivory colour

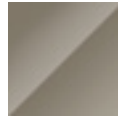

**LA07.G**  
laccato lucido  
col. tortora  
glossy lacquered  
dove grey colour

fondo cassetti in cuoietto  
drawer bottoms in leatherette

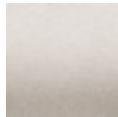

**CU01**  
col. avorio  
ivory colour



**CU02**  
col. tortora  
dove grey colour

basamento e dettagli in ottone  
base and details in brass



**ME01**  
bronzato  
bronzed



**ME02**  
bagno oro lucido  
shiny gold  
plated



**ME03**  
satinato  
satin finish



**ME04**  
cromo nero lucido  
shiny black chrome

divisorio in vetro con decoro  
a rombi  
divider in glass with diamond  
decoration



**VD01**  
vetro con decoro  
a rombi  
glass with diamond  
decoration

#### composizioni | compositions

- |   |                           |
|---|---------------------------|
| <p><b>A.</b> Rivestimento in pergamena lucida e interno in radica lucida.<br/>Cladding in glossy parchment and internal finish in glossy briar.</p> | <p><b>€ 30.450,00</b></p> |
| <p>Rivestimento in pergamena lucida e interno in carbalho lucido.<br/>Cladding in glossy parchment and internal finish in glossy carbalho wood.</p> | <p><b>€ 29.540,00</b></p> |
| <p><b>B.</b> Rivestimento in laccato lucido e interno in radica lucida.<br/>Cladding in glossy lacquering and internal finish in glossy briar.</p>  | <p><b>€ 25.410,00</b></p> |
| <p>Rivestimento in laccato lucido e interno in carbalho lucido.<br/>Cladding in glossy lacquering and internal finish in glossy carbalho wood.</p>  | <p><b>€ 24.500,00</b></p> |

Altre finiture disponibili su richiesta. | Other finishes available upon request.

## IL NOCE

### LIBRERIA SINGOLA | SINGLE BOOKCASE

by Fabio Crippa & Joe Gentile

dimensioni | dimensions L46 x P35 x H205 cm  
 peso | weight 90 kg  
 volume | volume 0,55 m<sup>3</sup>

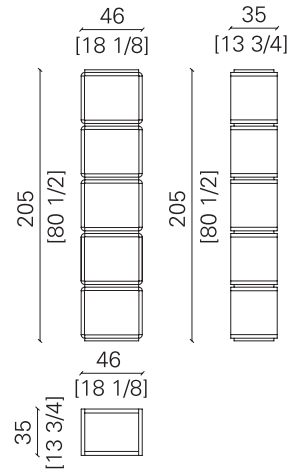

Libreria modulare singola con struttura in multistrato di pioppo impiallacciata in noce americano ed inserti in massello di noce americano tinto scuro lucido. Inserti decorativi in acciaio inox in finitura bagno oro lucido.

Modular single bookcase, with multi-ply poplar structure, veneered in American walnut, with solid glossy dark American walnut inserts. Decorative inserts in shiny gold plated stainless steel.

#### finiture | finishes

**A.** struttura in noce americano lucido  
 glossy American walnut structure

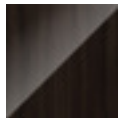

**NA01.G**  
 noce amer. scuro lucido  
 glossy dark American walnut



**NA02.G**  
 noce amer. naturale lucido  
 glossy natural American walnut

**B.** struttura in noce americano opaco  
 matt American walnut structure



**NA01.M**  
 noce amer. scuro opaco  
 matt dark American walnut



**NA02L.M**  
 noce amer. naturale opaco  
 matt natural American walnut

inserti decorativi in acciaio inox  
 decorative inserts in stainless steel



**ME02**  
 bagno oro lucido  
 shiny gold plated



**ME04**  
 cromo nero lucido  
 shiny black chrome

Altre finiture disponibili su richiesta. | Other finishes available upon request.



## IL NOCE

### LIBRERIA SINGOLA | SINGLE BOOKCASE

prezzo | price

composizioni | compositions

- |  |            |
|--|------------|
| <b>A.</b> Libreria in noce americano lucido con inserti decorativi.<br>Bookcase in glossy American walnut with decorative inserts. | € 5.310,00 |
| Libreria in noce americano lucido.<br>Bookcase in glossy American walnut.  | € 4.730,00 |
| <b>B.</b> Libreria in noce americano opaco con inserti decorativi.<br>Bookcase in matt American walnut with decorative inserts.    | € 4.780,00 |
| Libreria in noce americano opaco.<br>Bookcase in matt American walnut.   | € 4.200,00 |

Altre finiture disponibili su richiesta. | Other finishes available upon request.

## IL NOCE

### LIBRERIA SINGOLA CON ANTE | SINGLE BOOKCASE WITH DOORS

by Fabio Crippa & Joe Gentile

dimensioni | dimensions L46 x P35 x H205 cm  
 peso | weight 135 kg  
 volume | volume 0,55 m<sup>3</sup>

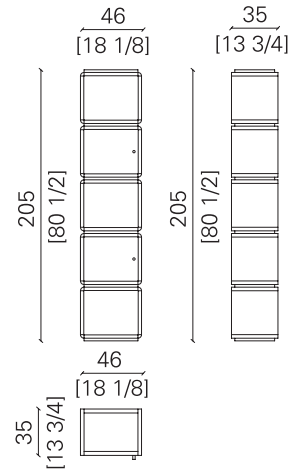

Libreria modulare singola con struttura in multistrato di pioppo impiallacciata in noce americano ed inserti in massello di noce americano tinto scuro lucido. Ante rivestite in pelle galuchat. Inserti decorativi e pomoli in acciaio inox in finitura bagno oro lucido.

Modular single bookcase, with multi-ply poplar structure, veneered in American walnut, with solid glossy dark American walnut inserts. Doors clad in galuchat leather. Decorative inserts and knobs in shiny gold plated stainless steel.

#### finiture | finishes

**A.** struttura in noce americano lucido  
 glossy American walnut structure

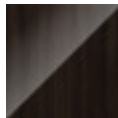

**NA01.G**  
 noce amer. scuro lucido  
 glossy dark American walnut



**NA02.G**  
 noce amer. naturale lucido  
 glossy natural American walnut

**B.** struttura in noce americano opaco  
 matt American walnut structure



**NA01.M**  
 noce amer. scuro opaco  
 matt dark American walnut



**NA02.L.M**  
 noce amer. naturale opaco  
 matt natural American walnut

inserti decorativi e pomoli in acciaio inox  
 decorative inserts and knobs in stainless steel



**ME02**  
 bagno oro lucido  
 shiny gold plated



**ME04**  
 cromo nero lucido  
 shiny black chrome

Altre finiture disponibili su richiesta. | Other finishes available upon request.

## IL NOCE

### LIBRERIA SINGOLA CON ANTE | SINGLE BOOKCASE WITH DOORS

quantità | quantity

prezzo | price

#### finiture | finishes

**C.** rivestimento anta in pelle galuchat  
door clad in galuchat leather



**GL06**  
galuchat

+ altri colori  
+ other colours

**12 pelli**

**D.** rivestimento anta in pelle  
door clad in leather



**MT6509**  
pelle  
leather

+ altri colori  
+ other colours

**0,3 mq**

#### composizioni | compositions

**AC.** Libreria in noce americano lucido con ante in pelle galuchat e inserti decorativi. € **10.140,00**

Bookcase in glossy American walnut with doors in galuchat leather and decorative inserts.

Libreria in noce americano lucido con ante in pelle galuchat. € **9.560,00**

Bookcase in glossy American walnut with doors in galuchat leather.

**AD.** Libreria in noce americano lucido con ante in pelle con inserti decorativi. € **7.380,00**

Bookcase in glossy American walnut with doors in leather with decorative inserts.

Libreria in noce americano lucido con ante in pelle. € **6.800,00**

Bookcase in glossy American walnut with doors in leather.

**BC.** Libreria in noce americano opaco con ante in pelle galuchat e inserti decorativi. € **9.610,00**

Bookcase in matt American walnut with doors in galuchat leather and decorative inserts.

Libreria in noce americano opaco con ante in pelle galuchat. € **9.030,00**

Bookcase in matt American walnut with doors in galuchat leather.

**BD.** Libreria in noce americano opaco con ante in pelle con inserti decorativi. € **6.860,00**

Bookcase in matt American walnut with doors in leather with decorative inserts.

Libreria in noce americano opaco con ante in pelle. € **6.280,00**

Bookcase in matt American walnut with doors in leather.

Altre finiture disponibili su richiesta. | Other finishes available upon request.

## IL NOCE

### LIBRERIA DOPPIA VARIANTE 1 | DOUBLE BOOKCASE VARIANT 1

by Fabio Crippa & Joe Gentile

dimensioni | dimensions L94 x P35 x H205 cm  
 peso | weight 190 kg  
 volume | volume 1,00 m<sup>3</sup>

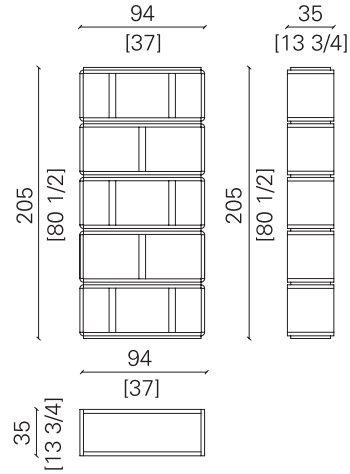

Libreria modulare doppia con struttura in multistrato di pioppo impiallacciata in noce americano ed inserti in massello di noce americano tinto scuro opaco. Divisori e inserti decorativi in acciaio inox in finitura bagno oro lucido.

Modular double bookcase, with multi-ply poplar structure, veneered in American walnut, with solid matt dark American walnut inserts. Dividers and decorative inserts in shiny gold plated stainless steel.

#### finiture | finishes

**A.** struttura in noce americano lucido  
 glossy American walnut structure



**NA01.G**  
 noce amer. scuro lucido  
 glossy dark American walnut



**NA02.G**  
 noce amer. naturale lucido  
 glossy natural American walnut

**B.** struttura in noce americano opaco  
 matt American walnut structure



**NA01.M**  
 noce amer. scuro opaco  
 matt dark American walnut



**NA02.L.M**  
 noce amer. naturale opaco  
 matt natural American walnut

inserti decorativi e anelli divisori in acciaio inox  
 decorative inserts and divider rings in stainless steel



**ME02**  
 bagno oro lucido  
 shiny gold plated



**ME04**  
 cromo nero lucido  
 shiny black chrome

Altre finiture disponibili su richiesta. | Other finishes available upon request.

## IL NOCE

LIBRERIA DOPPIA VARIANTE 1 | DOUBLE BOOKCASE VARIANT 1

prezzo | price

composizioni | compositions

- |  |                    |
|--|--------------------|
| <b>A.</b> Libreria in noce americano lucido con inserti decorativi.<br>Bookcase in glossy American walnut with decorative inserts. | <b>€ 11.540,00</b> |
| Libreria in noce americano lucido.<br>Bookcase in glossy American walnut.  | <b>€ 10.570,00</b> |
| <b>B.</b> Libreria in noce americano opaco con inserti decorativi.<br>Bookcase in matt American walnut with decorative inserts.    | <b>€ 10.840,00</b> |
| Libreria in noce americano opaco.<br>Bookcase in matt American walnut.   | <b>€ 9.870,00</b>  |

Altre finiture disponibili su richiesta. | Other finishes available upon request.

## IL NOCE

### LIBRERIA DOPPIA VARIANTE 2 | DOUBLE BOOKCASE VARIANT 2

by Fabio Crippa & Joe Gentile

dimensioni | dimensions  
peso | weight  
volume | volume

L94 x P35 x H205 cm  
190 kg  
1,00 m<sup>3</sup>

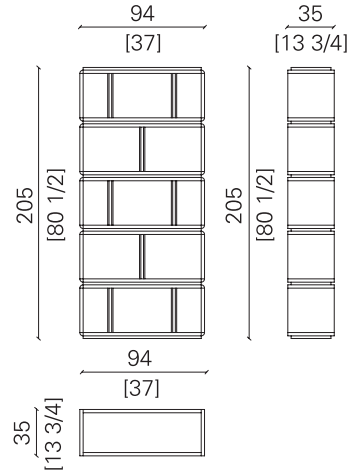

Libreria modulare doppia con struttura in multistrato di pioppo impiallacciata in noce americano e divisori in massello di noce americano tinto scuro opaco. Inserti decorativi in acciaio inox in finitura bagno oro lucido.

Modular double bookcase, with multi-ply poplar structure, veneered in American walnut, with solid matt dark American walnut dividers. Decorative inserts in shiny gold plated stainless steel.

#### finiture | finishes

**A.** struttura in noce americano lucido  
glossy American walnut structure

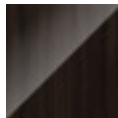

**NA01.G**  
noce amer. scuro lucido  
glossy dark American walnut



**NA02.G**  
noce amer. naturale lucido  
glossy natural American walnut

**B.** struttura in noce americano opaco  
matt American walnut structure



**NA01.M**  
noce amer. scuro opaco  
matt dark American walnut



**NA02.L.M**  
noce amer. naturale opaco  
matt natural American walnut

inserti decorativi in acciaio inox  
decorative inserts in stainless steel



**ME02**  
bagno oro lucido  
shiny gold plated



**ME04**  
cromo nero lucido  
shiny black chrome

Altre finiture disponibili su richiesta. | Other finishes available upon request.

## IL NOCE

LIBRERIA DOPPIA VARIANTE 2 | DOUBLE BOOKCASE VARIANT 2

prezzo | price

composizioni | compositions

- |  |                    |
|--|--------------------|
| <b>A.</b> Libreria in noce americano lucido con inserti decorativi.<br>Bookcase in glossy American walnut with decorative inserts. | <b>€ 11.260,00</b> |
| Libreria in noce americano lucido.<br>Bookcase in glossy American walnut.  | <b>€ 10.290,00</b> |
| <b>B.</b> Libreria in noce americano opaco con inserti decorativi.<br>Bookcase in matt American walnut with decorative inserts.    | <b>€ 10.560,00</b> |
| Libreria in noce americano opaco.<br>Bookcase in matt American walnut.   | <b>€ 9.590,00</b>  |

Altre finiture disponibili su richiesta. | Other finishes available upon request.

## IL NOCE

### LIBRERIA DOPPIA CON ANTE VARIANTE 1 | DOUBLE BOOKCASE WITH DOORS VARIANT 1

by Fabio Crippa & Joe Gentile

dimensioni | dimensions L94 x P35 x H205 cm  
 peso | weight 250 kg  
 volume | volume 1,00 m<sup>3</sup>

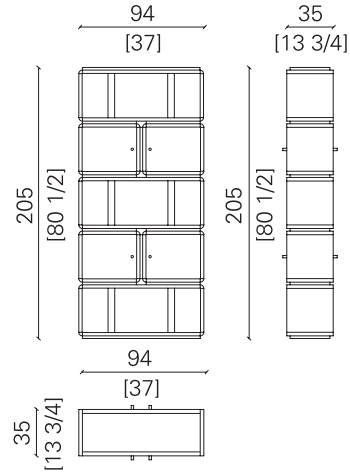

Libreria modulare doppia con struttura in multistrato di pioppo impiallacciata in noce americano ed inserti in massello di noce americano tinto scuro opaco. Ante rivestite in pelle galuchat. Inserti, anelli divisori e pomoli in acciaio inox in finitura bagno oro lucido.

Modular double bookcase, with multi-ply poplar structure, veneered in American walnut, with solid matt dark American walnut inserts. Doors clad in galuchat leather. Inserts, divider rings, and knobs in shiny gold plated stainless steel.

#### finiture | finishes

**A.** struttura in noce americano lucido  
 glossy American walnut structure

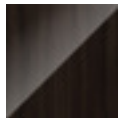

**NA01.G**  
 noce amer. scuro lucido  
 glossy dark American walnut



**NA02.G**  
 noce amer. naturale lucido  
 glossy natural American walnut

**B.** struttura in noce americano opaco  
 matt American walnut structure



**NA01.M**  
 noce amer. scuro opaco  
 matt dark American walnut



**NA02.L.M**  
 noce amer. naturale opaco  
 matt natural American walnut

inserti decorativi e anelli divisori in acciaio inox  
 decorative inserts and divider rings in stainless steel



**ME02**  
 bagno oro lucido  
 shiny gold plated



**ME04**  
 cromo nero lucido  
 shiny black chrome



Altre finiture disponibili su richiesta. | Other finishes available upon request.



## IL NOCE

### LIBRERIA DOPPIA CON ANTE VARIANTE 1 | DOUBLE BOOKCASE WITH DOORS VARIANT 1

quantità | quantity      prezzo | price

finiture   finishes			
<b>C.</b> rivestimento anta in pelle galuchat door clad in galuchat leather		+ altri colori + other colours	<b>24 pelli</b>
	<b>GL06</b> galuchat		
<b>D.</b> rivestimento anta in pelle door clad in leather		+ altri colori + other colours	<b>0,6 mq</b>
	<b>MT6509</b> pelle leather		
composizioni   compositions			
<b>AC.</b> Libreria in noce americano lucido con ante in pelle galuchat e inserti decorativi. Bookcase in glossy American walnut with doors in galuchat leather and decorative inserts.			<b>€ 21.130,00</b>
Libreria in noce americano lucido con ante in pelle galuchat. Bookcase in glossy American walnut with doors in galuchat leather.			<b>€ 20.160,00</b>
<b>AD.</b> Libreria in noce americano lucido con ante in pelle con inserti decorativi. Bookcase in glossy American walnut with doors in leather with decorative inserts.			<b>€ 15.610,00</b>
Libreria in noce americano lucido con ante in pelle. Bookcase in glossy American walnut with doors in leather.			<b>€ 14.650,00</b>
<b>BC.</b> Libreria in noce americano opaco con ante in pelle galuchat e inserti decorativi. Bookcase in matt American walnut with doors in galuchat leather and decorative inserts.			<b>€ 20.430,00</b>
Libreria in noce americano opaco con ante in pelle galuchat. Bookcase in matt American walnut with doors in galuchat leather.			<b>€ 19.460,00</b>
<b>BD.</b> Libreria in noce americano opaco con ante in pelle con inserti decorativi. Bookcase in matt American walnut with doors in leather with decorative inserts.			<b>€ 14.910,00</b>
Libreria in noce americano opaco con ante in pelle. Bookcase in matt American walnut with doors in leather.			<b>€ 13.950,00</b>

Altre finiture disponibili su richiesta. | Other finishes available upon request.

## IL NOCE

### LIBRERIA DOPPIA CON ANTE VARIANTE 2 | DOUBLE BOOKCASE WITH DOORS VARIANT 2

by Fabio Crippa & Joe Gentile

dimensioni | dimensions L94 x P35 x H205 cm  
 peso | weight 250 kg  
 volume | volume 1,00 m<sup>3</sup>

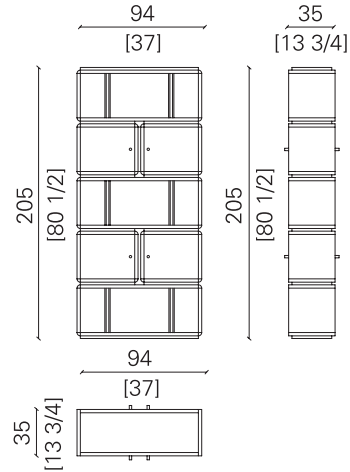

Libreria modulare doppia con struttura in multistrato di pioppo impiallacciata in noce americano e divisori in massello di noce americano tinto scuro opaco. Ante rivestite in pelle galuchat. Inserti e pomoli in acciaio inox in finitura bagno oro lucido.

Modular double bookcase, with multi-ply poplar structure, veneered in American walnut, with solid matt dark American walnut dividers. Doors clad in galuchat leather. Inserts and knobs in shiny gold plated stainless steel.

#### finiture | finishes

**A.** struttura in noce americano lucido  
 glossy American walnut structure

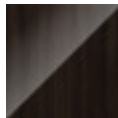

**NA01.G**  
 noce amer. scuro lucido  
 glossy dark American walnut



**NA02.G**  
 noce amer. naturale lucido  
 glossy natural American walnut

**B.** struttura in noce americano opaco  
 matt American walnut structure



**NA01.M**  
 noce amer. scuro opaco  
 matt dark American walnut



**NA02.L.M**  
 noce amer. naturale opaco  
 matt natural American walnut

inserti decorativi e pomoli in acciaio inox  
 decorative inserts and knobs in stainless steel



**ME02**  
 bagno oro lucido  
 shiny gold plated





**ME04**  
 cromo nero lucido  
 shiny black chrome

Altre finiture disponibili su richiesta. | Other finishes available upon request.

## IL NOCE

### LIBRERIA DOPPIA CON ANTE VARIANTE 2 | DOUBLE BOOKCASE WITH DOORS VARIANT 2

quantità | quantity      prezzo | price

finiture   finishes			
<b>C.</b> rivestimento anta in pelle galuchat door clad in galuchat leather		+ altri colori + other colours	<b>24 pelli</b>
	<b>GL06</b> galuchat		
<b>D.</b> rivestimento anta in pelle door clad in leather		+ altri colori + other colours	<b>0,6 mq</b>
	<b>MT6509</b> pelle leather		
composizioni   compositions			
<b>AC.</b> Libreria in noce americano lucido con ante in pelle galuchat e inserti decorativi. Bookcase in glossy American walnut with doors in galuchat leather and decorative inserts.			<b>€ 20.920,00</b>
Libreria in noce americano lucido con ante in pelle galuchat. Bookcase in glossy American walnut with doors in galuchat leather.			<b>€ 19.950,00</b>
<b>AD.</b> Libreria in noce americano lucido con ante in pelle con inserti decorativi. Bookcase in glossy American walnut with doors in leather with decorative inserts.			<b>€ 15.400,00</b>
Libreria in noce americano lucido con ante in pelle. Bookcase in glossy American walnut with doors in leather.			<b>€ 14.440,00</b>
<b>BC.</b> Libreria in noce americano opaco con ante in pelle galuchat e inserti decorativi. Bookcase in matt American walnut with doors in galuchat leather and decorative inserts.			<b>€ 20.220,00</b>
Libreria in noce americano opaco con ante in pelle galuchat. Bookcase in matt American walnut with doors in galuchat leather.			<b>€ 19.250,00</b>
<b>BD.</b> Libreria in noce americano opaco con ante in pelle con inserti decorativi. Bookcase in matt American walnut with doors in leather with decorative inserts.			<b>€ 14.700,00</b>
Libreria in noce americano opaco con ante in pelle. Bookcase in matt American walnut with doors in leather.			<b>€ 13.740,00</b>

Altre finiture disponibili su richiesta. | Other finishes available upon request.

# IL NOCE

**VARIANTE 1** composizione moduli con inserti decorativi | **VARIANT 1** modular composition with decorative inserts

prezzo | price

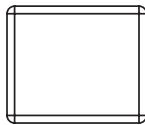
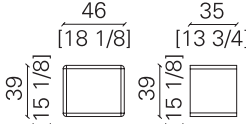
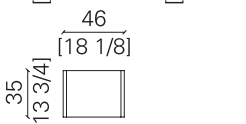
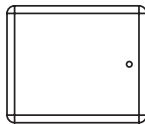
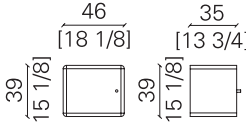
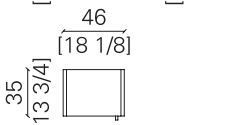
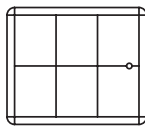
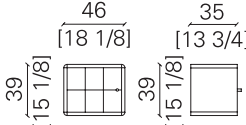
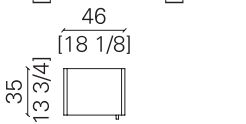
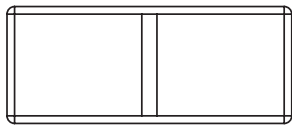
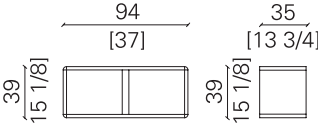
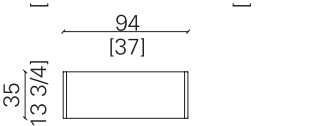
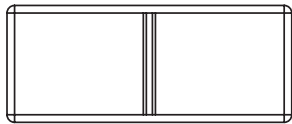
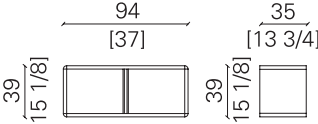
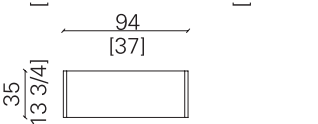
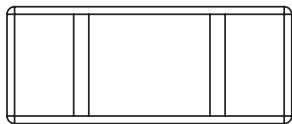
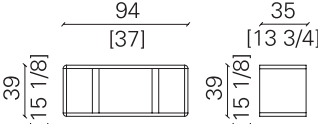
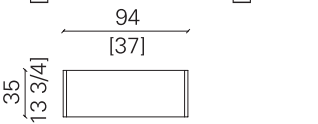
moduli   modules				
<b>MOD_1_01</b>			lucido · glossy	€ 1.070,00
			opaco · matt	€ 960,00
<b>MOD_1_02</b>			lucido · glossy	€ 2.100,00
			opaco · matt	€ 2.000,00
<b>MOD_1_03</b>			lucido · glossy	€ 3.480,00
			opaco · matt	€ 3.380,00
<b>MOD_1_04</b>			lucido · glossy	€ 2.120,00
			opaco · matt	€ 1.980,00
<b>MOD_1_05</b>			lucido · glossy	€ 2.090,00
			opaco · matt	€ 1.950,00
<b>MOD_1_06</b>			lucido · glossy	€ 2.440,00
			opaco · matt	€ 2.300,00

Altre finiture disponibili su richiesta. | Other finishes available upon request.

# IL NOCE

**VARIANTE 1** composizione moduli con inserti decorativi | **VARIANT 1** modular composition with decorative inserts

prezzo | price

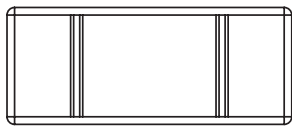
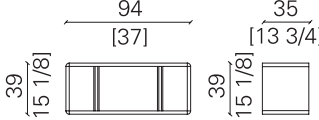
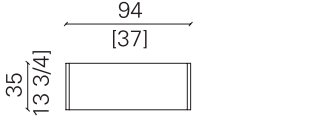
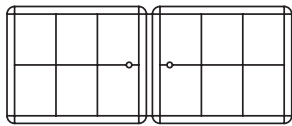
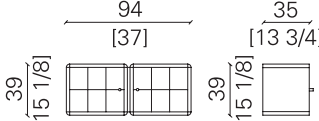
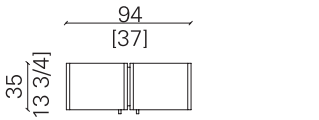
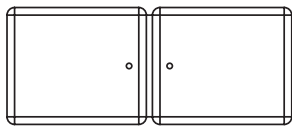
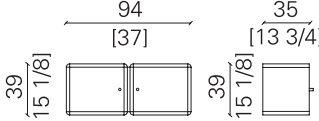
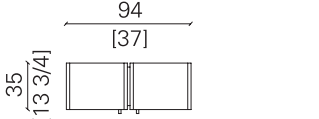
moduli   modules				
<b>MOD_1_07</b>			lucido · glossy	€ 2.370,00
			opaco · matt	€ 2.230,00
<b>MOD_1_08</b>			lucido · glossy	€ 6.920,00
			opaco · matt	€ 6.780,00
<b>MOD_1_09</b>			lucido · glossy	€ 4.160,00
			opaco · matt	€ 4.020,00

Altre finiture disponibili su richiesta. | Other finishes available upon request.

# IL NOCE

**VARIANTE 2** composizione moduli senza inserti decorativi | **VARIANT 2** modular composition without decorative inserts

prezzo | price

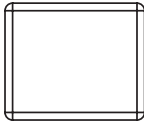
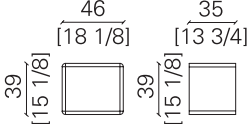
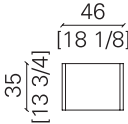
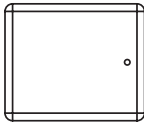
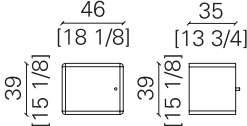
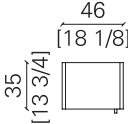
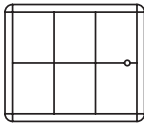
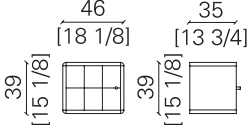
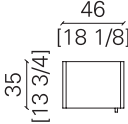
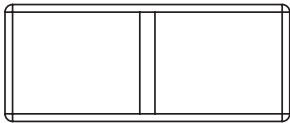
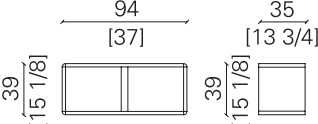
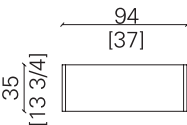
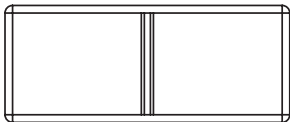
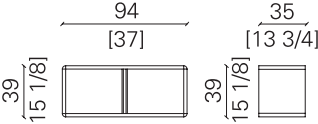
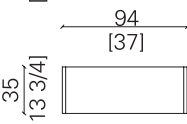
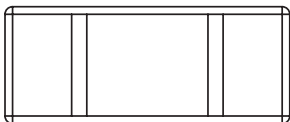
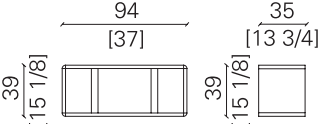
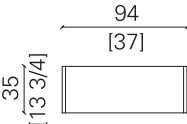
moduli   modules				
<b>MOD_2_01</b>			lucido · glossy	€ 950,00
			opaco · matt	€ 840,00
<b>MOD_2_02</b>			lucido · glossy	€ 1.990,00
			opaco · matt	€ 1.880,00
<b>MOD_2_03</b>			lucido · glossy	€ 3.360,00
			opaco · matt	€ 3.260,00
<b>MOD_2_04</b>			lucido · glossy	€ 1.930,00
			opaco · matt	€ 1.790,00
<b>MOD_2_05</b>			lucido · glossy	€ 1.890,00
			opaco · matt	€ 1.750,00
<b>MOD_2_06</b>			lucido · glossy	€ 2.240,00
			opaco · matt	€ 2.100,00

Altre finiture disponibili su richiesta. | Other finishes available upon request.

# IL NOCE

**VARIANTE 2** composizione moduli senza inserti decorativi | **VARIANT 2** modular composition without decorative inserts

prezzo | price

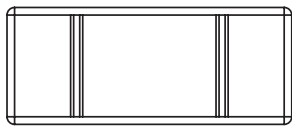
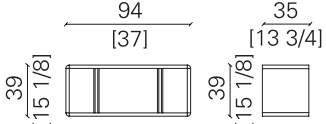
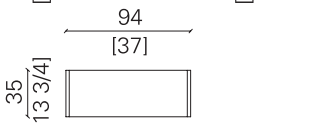
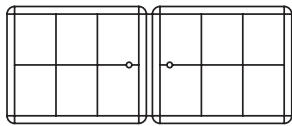
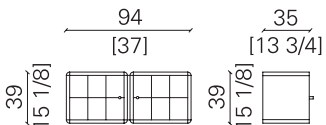
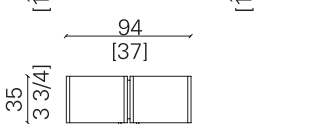
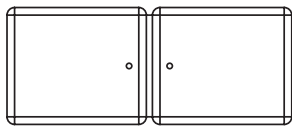
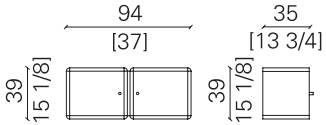
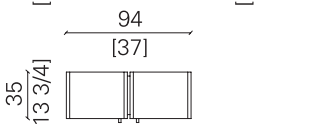
moduli   modules				
<b>MOD_2_07</b>			lucido · glossy	€ 2.170,00
			opaco · matt	€ 2.030,00
<b>MOD_2_08</b>			lucido · glossy	€ 6.720,00
			opaco · matt	€ 6.580,00
<b>MOD_2_09</b>			lucido · glossy	€ 3.970,00
			opaco · matt	€ 3.830,00

Altre finiture disponibili su richiesta. | Other finishes available upon request.

## IL MELOGRANO

### PARAVENTO MODULO A | SCREEN MODULE A

by Fabio Crippa & Joe Gentile

dimensioni | dimensions  
peso | weight  
volume | volume

L46 x P7 x H270 cm  
45 kg  
0,27 m<sup>3</sup>

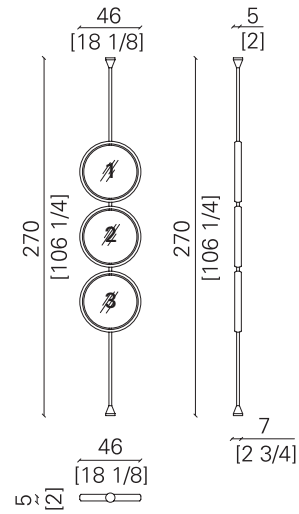

Paravento decorativo con struttura in ottone in finitura cromo nero lucido con tre anelli in noce americano tinto scuro opaco. Pannello tondo girevole bifacciale con specchio naturale e imbottitura in tessuto decorativo o pelle sul retro.

Decorative screen with shiny black chromed brass structure, with three rings in matt dark American walnut. Round two-sided swivel panel, with natural mirror and decorative fabric or leather upholstery on the back.

#### finiture | finishes

specchio  
mirror



**SP01**  
specchio  
naturale  
natural mirror



**SP02**  
specchio  
bronzato  
bronzed mirror



**SP03**  
specchio fumé  
smoked mirror

**A.** anelli in noce americano  
lucido  
rings in glossy American  
walnut

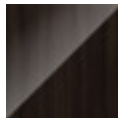

**NA01.G**  
noce amer.  
scuro lucido  
glossy dark  
American  
walnut



**NA02.G**  
noce amer.  
naturale lucido  
glossy natural  
American  
walnut

**B.** anelli in noce americano  
opaco  
rings in matt American  
walnut



**NA01.M**  
noce amer.  
scuro opaco  
matt dark  
American  
walnut



**NA02.L.M**  
noce amer.  
naturale opaco  
matt natural  
American  
walnut

Altre finiture disponibili su richiesta. | Other finishes available upon request.



## IL MELOGRANO

### PARAVENTO MODULO A | SCREEN MODULE A

quantità | quantity

prezzo | price

#### finiture | finishes

1. imbottitura in pelle nabuk  
nubuck leather upholstery

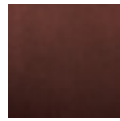

**NK2135**  
nabuk  
nubuck

+ altri colori  
+ other colours

0,5 mq

2. imbottitura in tessuto  
fabric upholstery

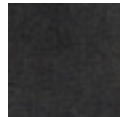

**ELNB880**  
tessuto  
fabric

+ altri colori  
+ other colours

0,5 mtl

3. imbottitura in tessuto  
fabric upholstery



**NBVP53**  
tessuto  
fabric

+ altri colori  
+ other colours

0,5 mtl

struttura in ottone  
brass structure



**ME01**  
bronzato  
bronzed



**ME02**  
bagno oro lucido  
shiny gold  
plated



**ME03**  
satinato  
satin finish



**ME04**  
cromo nero lucido  
shiny black chrome

#### composizioni | compositions

**A.** Paravento con anelli in noce americano lucido.  
Screen with rings in glossy American walnut.

€ 4.440,00

**B.** Paravento con anelli in noce americano opaco.  
Screen with rings in matt American walnut.

€ 4.330,00

Altre finiture disponibili su richiesta. | Other finishes available upon request.

# IL MELOGRANO

## PARAVENTO MODULO B | SCREEN MODULE B

by Fabio Crippa & Joe Gentile

dimensioni | dimensions  
peso | weight  
volume | volume

L46 x P7 x H270 cm  
55 kg  
0,27 m<sup>3</sup>

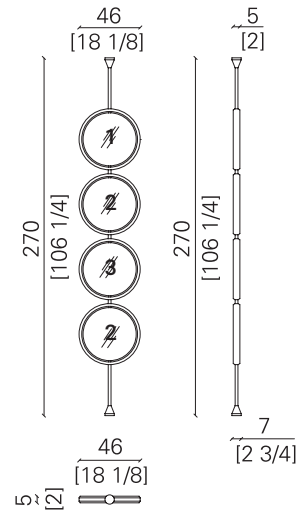

Paravento decorativo con struttura in ottone in finitura cromo nero lucido con quattro anelli in noce americano tinto scuro opaco. Pannello tondo girevole bifacciale con specchio naturale e imbottitura in tessuto decorativo o pelle sul retro.

Decorative screen with shiny black chromed brass structure, with four rings in matt dark American walnut. Round two-sided swivel panel, with natural mirror and decorative fabric or leather upholstery on the back.

### finiture | finishes

specchio  
mirror



**SP01**  
specchio  
naturale  
natural mirror



**SP02**  
specchio  
bronzato  
bronzed mirror



**SP03**  
specchio fumé  
smoked mirror

**A.** anelli in noce americano  
lucido  
rings in glossy American  
walnut

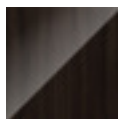

**NA01.G**  
noce amer.  
scuro lucido  
glossy dark  
American  
walnut



**NA02.G**  
noce amer.  
naturale lucido  
glossy natural  
American  
walnut

**B.** anelli in noce americano  
opaco  
rings in matt American  
walnut



**NA01.M**  
noce amer.  
scuro opaco  
matt dark  
American  
walnut



**NA02.L.M**  
noce amer.  
naturale opaco  
matt natural  
American  
walnut

Altre finiture disponibili su richiesta. | Other finishes available upon request.

## IL MELOGRANO

### PARAVENTO MODULO B | SCREEN MODULE B

quantità | quantity

prezzo | price

finiture | finishes

1. imbottitura in pelle nabuk  
nubuck leather upholstery

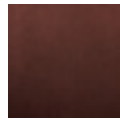

**NK2135**  
nabuk  
nubuck

+ altri colori  
+ other colours

0,2 mq

2. imbottitura in tessuto  
fabric upholstery

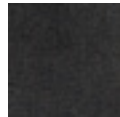

**ELNB880**  
tessuto  
fabric

+ altri colori  
+ other colours

0,5 mtl

3. imbottitura in tessuto  
fabric upholstery



**NBVP53**  
tessuto  
fabric

+ altri colori  
+ other colours

0,5 mtl

struttura in ottone  
brass structure



**ME01**  
bronzato  
bronzed



**ME02**  
bagno oro lucido  
shiny gold  
plated



**ME03**  
satinato  
satin finish



**ME04**  
cromo nero lucido  
shiny black chrome

composizioni | compositions

**A.** Paravento con anelli in noce americano lucido.  
Screen with rings in glossy American walnut.

€ 5.440,00

**B.** Paravento con anelli in noce americano opaco.  
Screen with rings in matt American walnut.

€ 5.290,00

Altre finiture disponibili su richiesta. | Other finishes available upon request.

# IL LAURO

## PARAVENTO | SCREEN

by Fabio Crippa & Joe Gentile

dimensioni | dimensions L211 x P4 x H190 cm  
 peso | weight 128 kg  
 volume | volume 0,40 m<sup>3</sup>

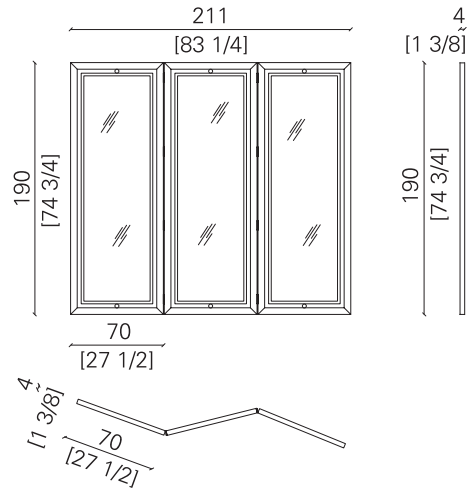

Paravento decorativo con struttura in massello di noce americano tinto scuro lucido, profili in ottone in finitura bronzata, pannello bifacciale con specchio naturale e imbottitura in tessuto decorativo sul retro.

Decorative screen with solid glossy dark American walnut structure, profiles in bronzed brass, two-sided panel with natural mirror and in decorative fabric upholstery on the back.

### finiture | finishes

specchio  
mirror



**SP01**  
specchio  
naturale  
natural mirror



**SP02**  
specchio  
bronzato  
bronzed mirror



**SP03**  
specchio fumé  
smoked mirror

**A.** struttura in noce americano  
lucido  
structure in glossy American  
walnut



**NA01.G**  
noce amer.  
scuro lucido  
glossy dark  
American  
walnut



**NA02.G**  
noce amer.  
naturale lucido  
glossy natural  
American  
walnut

**B.** struttura in noce americano  
opaco  
structure in matt American  
walnut



**NA01.M**  
noce amer.  
scuro opaco  
matt dark  
American  
walnut

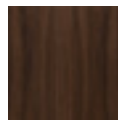

**NA02.L.M**  
noce amer.  
naturale opaco  
matt natural  
American  
walnut

Altre finiture disponibili su richiesta. | Other finishes available upon request.

## IL LAURO

### PARAVENTO | SCREEN

quantità | quantity

prezzo | price

#### finiture | finishes

tessuto decorativo  
variante 1  
decorative fabric  
variant 1

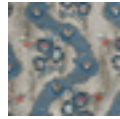

+ altri colori  
+ other colours

4 mtl

**DEDM004**  
tessuto  
fabric

tessuto decorativo  
variante 2  
decorative fabric  
variant 2

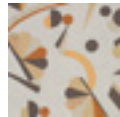

+ altri colori  
+ other colours

4 mtl

**DEMF003**  
tessuto  
fabric

dettagli in ottone  
brass details



**ME01**  
bronzato  
bronzed



**ME02**  
bagno oro lucido  
shiny gold  
plated



**ME03**  
satinato  
satin finish



**ME04**  
cromo nero lucido  
shiny black chrome

#### composizioni | compositions

**A.** Paravento in noce americano lucido con tessuto decorativo.  
Screen in glossy American walnut with decorative fabric.

€ 10.170,00

**B.** Paravento in noce americano opaco con tessuto decorativo.  
Screen in matt American walnut with decorative fabric.

€ 9.900,00

Altre finiture disponibili su richiesta. | Other finishes available upon request.

# L'ALLORO

## SPECCHIO | MIRROR

by Fabio Crippa & Joe Gentile

dimensioni | dimensions  
peso | weight  
volume | volume

Ø140 x P8 cm  
45 kg  
0,40 m<sup>3</sup>

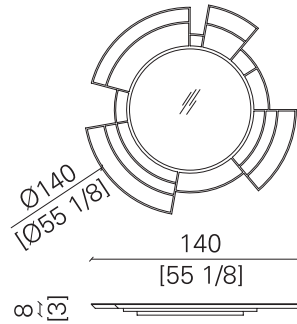
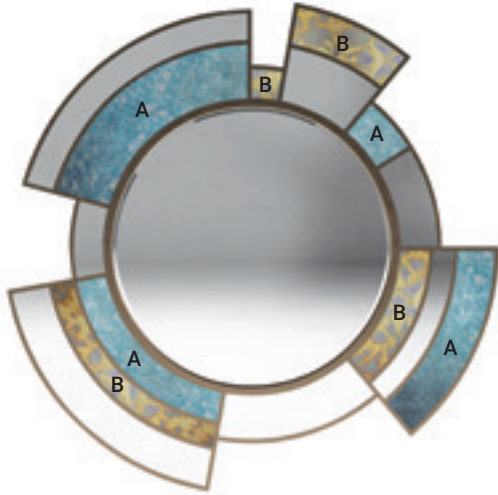

Specchio decorativo con inserti in specchio naturale e specchio anticato in due colori. Cornice in ottone in finitura bronzata. Retroilluminazione a LED.

Decorative mirror with natural mirror inserts and two-tone antiqued mirror. Frame in bronzed brass. LED backlighting.

### finiture | finishes

specchio centrale rotondo  
round central mirror



**SP01**  
specchio naturale  
natural mirror

inserto decorativo A + B  
decorative insert A + B



**AQ01**  
specchio anticato  
col. cobalto  
antiqued mirror  
cobalt colour



**AQ02**  
specchio anticato  
col. arcobaleno  
antiqued mirror  
rainbow colour

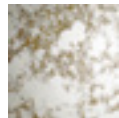

**AQ01**  
specchio anticato  
col. cometa  
antiqued mirror  
comet colour



**SP02**  
specchio bronzato  
bronzed  
mirror



**SP03**  
specchio fumé  
smoked  
mirror

cornice in ottone  
brass frame



**ME01**  
bronzato  
bronzed



**ME02**  
bagno oro lucido  
shiny gold  
plated



**ME03**  
satinato  
satin finish

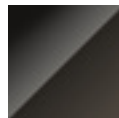

**ME04**  
cromo nero lucido  
shiny black chrome

### composizioni | compositions

Finitura come da immagine.  
Finish as shown in image.

€ 8.580,00

Altre finiture disponibili su richiesta. | Other finishes available upon request.

## IL BOSSO

### SPECCHIO | MIRROR

by Fabio Crippa & Joe Gentile

dimensioni | dimensions  
peso | weight  
volume | volume

L90 x P6 x H200 cm  
65 kg  
0,35 m<sup>3</sup>

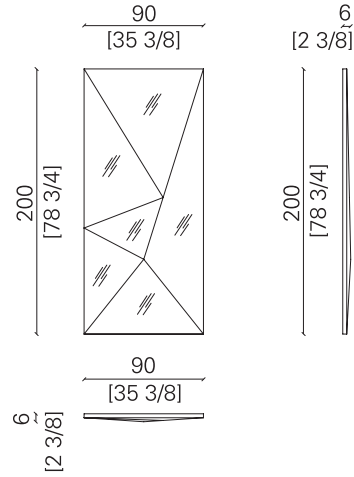

Specchio decorativo con sfaccettatura a taglio diamante e struttura interna in laccato nero opaco.

Decorative mirror with diamond cut facets, and matt black lacquered internal structure.

#### finiture | finishes

specchio  
mirror



**SP01**  
specchio  
naturale  
natural mirror



**SP02**  
specchio  
bronzato  
bronzed mirror



**SP03**  
specchio fumé  
smoked mirror

#### composizioni | compositions

Finitura come da immagine.  
Finish as shown in image.

€ 8.230,00

Altre finiture disponibili su richiesta. | Other finishes available upon request.

# IL SAMBUCO

## TAVOLINO BASSO | COFFEE TABLE

by Fabio Crippa & Joe Gentile

dimensioni | dimensions L151 x P108 x H35 cm  
 peso | weight 70 kg  
 volume | volume 0,90 m<sup>3</sup>

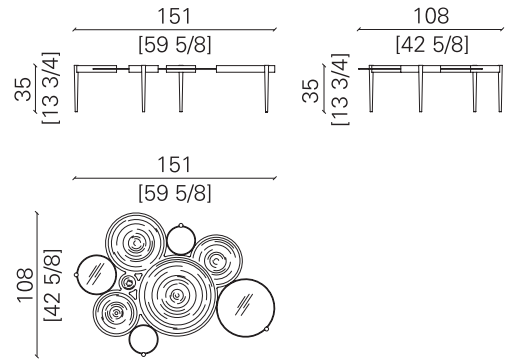

Tavolino con piano e piedini in ottone in finitura bronzata. Il piano è impreziosito in superficie con decorazione a cerchi concentrici in fresata con inserti di pianetti in pietra semipreziosa Labradorite e pianetti in vetro bronzato temperato.

Coffee table with top and legs in bronzed brass. The top is enhanced on its surface by concentric milled circle decorations, with inserts in semi-precious Labradorite stone, and tempered bronzed glass.

### finiture | finishes

inserti piano in  
pietra semipreziosa  
top inserts in  
semi-precious stone



**PS01**  
Labradorite



**PS03**  
Ametista  
Amethyst

inserti piano in vetro  
glass inserts



**VE01**  
vetro extrach.  
extra-clear  
glass



**VE02**  
vetro bronzato  
bronzed  
glass



**VE03**  
vetro fumé  
smoked  
glass

piano e struttura in ottone  
brass top and structure



**ME01**  
bronzato  
bronzed

### composizioni | compositions

Finitura come da immagine.  
Finish as shown in image.

### prezzo | price

€ 12.460,00

Altre finiture disponibili su richiesta. | Other finishes available upon request.



IL SALOTTO | THE LIVING ROOM

## LA ROBINIA D'ORO

### TAVOLINO BASSO | COFFEE TABLE

by Fabio Crippa & Joe Gentile

dimensioni | dimensions  
peso | weight  
volume | volume

Ø90 x H40 cm  
25 kg  
0,50 m<sup>3</sup>

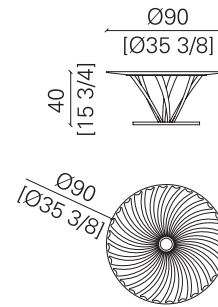

Tavolino basso rotondo con piano e basamento intarsiati a ventaglio in radica di mirto in due tonalità. Piano e struttura in ottone in finitura bagno oro lucido.

Round coffee table with top and base inlaid in a fan pattern in two-tone myrtle briar. Top and structure in shiny gold plated brass.

#### finiture | finishes

intarsio piano in radica di mirto lucida  
top inlay in glossy myrtle briar



**RA01.G**  
radica di mirto  
col. naturale  
myrtle briar  
natural colour

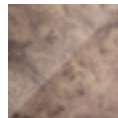

**RA02.G**  
radica di mirto  
col. avorio  
myrtle briar  
ivory colour

intarsio basamento in radica di mirto lucida  
base inlay in glossy myrtle briar



**RA01.G**  
radica di mirto  
col. naturale  
myrtle briar  
natural colour

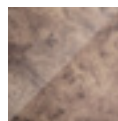

**RA02.G**  
radica di mirto  
col. avorio  
myrtle briar  
ivory colour

piano e struttura in ottone  
brass top and structure



**ME02**  
bagno oro lucido  
shiny gold  
plated

#### composizioni | compositions

Finitura come da immagine.  
Finish as shown in image.

#### prezzo | price

€ 14.560,00

Altre finiture disponibili su richiesta. | Other finishes available upon request.

# I RODODENDRI

## TAVOLINO BASSO | COFFEE TABLE

by Fabio Crippa & Joe Gentile

dimensioni | dimensions  
peso | weight  
volume | volume

Ø90 x H40 cm  
29 kg  
0,50 m<sup>3</sup>

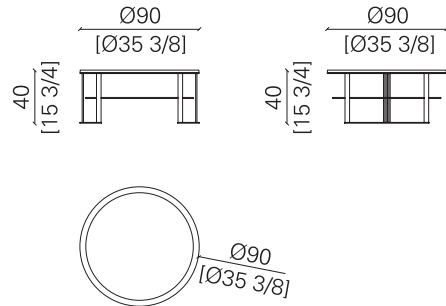

Tavolino basso rotondo con struttura in ottone in finitura bronzata e cornice piano in erable lucido color blu cobalto. Inserto piano in pietra semipreziosa Labradorite con anello in ottone in finitura bronzata. Ripiano in vetro bronzato temperato.

Round coffee table with bronzed brass structure and top frame in glossy cobalt blue maple. Top insert in Labradorite semi-precious stone, with bronzed brass ring. Tempered bronzed glass shelf.

finiture | finishes

**A.** inserto piano in pietra semipreziosa  
top insert in semi-precious stone



**PS01**  
Labradorite



**PS02**  
Ferro Tigrato  
Tiger Iron



**PS03**  
Ametista  
Amethyst



**PS04**  
Occhio di Tigre  
Tiger's Eye

**B.** inserto piano in marmo  
top insert in marble



**MA.C01**  
Azul Bahia



**MA.C02**  
Rosso Lepanto

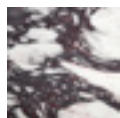

**MA.C03**  
Calacatta Viola

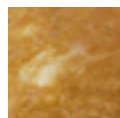

**MA.C04**  
Giallo Siena



**MA.N01**  
Nero Marquina

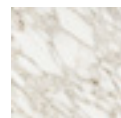

**MA.B01**  
Calacatta  
Vagli Oro



**MA.T02**  
Bronze Amani

cornice piano in erable lucido  
top frame in glossy maple



**ER01.G**  
erable lucido  
col. blu cobalto  
glossy maple  
cobalt blue

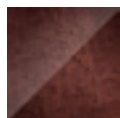

**ER02.G**  
erable lucido  
col. rosso marsala  
glossy maple  
marsala red

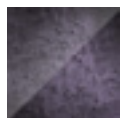

**ER03.G**  
erable lucido  
col. ametista  
glossy maple  
amethyst

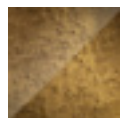

**ER04.G**  
erable lucido  
col. giallo oca  
glossy maple  
ocher yellow



**ER05.G**  
erable lucido  
col. nero  
glossy maple  
black colour



**ER06.G**  
erable lucido  
col. avorio  
glossy maple  
ivory colour

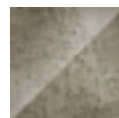

**ER07.G**  
erable lucido  
col. tortora  
glossy maple  
dove grey colour

cornice piano in eucalipto frisé lucido  
top frame in glossy frisé eucalyptus



**EF01.G**  
eucalipto  
col. blu cobalto  
glossy eucalyptus  
cobalt blue colour



**EF02.G**  
eucalipto col.  
col. rosso marsala  
glossy eucalyptus  
marsala red  
colour



**EF03.G**  
eucalipto  
col. ametista  
glossy eucalyptus  
amethyst colour



**EF04.G**  
eucalipto  
col. giallo oca  
glossy eucalyptus  
ocher yellow  
colour



**EF05.G**  
eucalipto  
col. nero  
glossy eucalyptus  
black colour



**EF06.G**  
eucalipto  
col. avorio  
glossy eucalyptus  
ivory colour

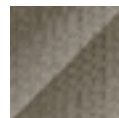

**EF07.G**  
eucalipto  
col. tortora  
glossy eucalyptus  
dove grey colour

Altre finiture disponibili su richiesta. | Other finishes available upon request.

# I RODODENDRI

## TAVOLINO BASSO | COFFEE TABLE

prezzo | price

finiture | finishes

**C.** piano in erable lucido  
top in glossy maple



**ER01.G**  
erable lucido  
blu cobalto  
glossy maple  
cobalt blue



**ER02.G**  
erable lucido  
rosso marsala  
glossy maple  
marsala red

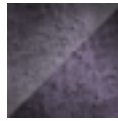

**ER03.G**  
erable lucido  
ametista  
glossy maple  
amethyst

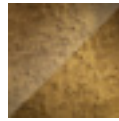

**ER04.G**  
erable lucido  
giallo ocre  
glossy maple  
ocher yellow



**ER05.G**  
erable lucido  
col. nero  
glossy maple  
black colour

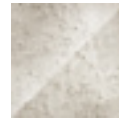

**ER06.G**  
erable lucido  
col. avorio  
glossy maple  
ivory colour



**ER07.G**  
erable lucido  
col. tortora  
glossy maple  
dove grey  
colour

**D.** piano in eucalipto  
frisè lucido  
top in glossy frisè  
eucalyptus



**EF01.G**  
eucalipto  
col. blu cobalto  
glossy eucalyptus  
cobalt blue colour



**EF02.G**  
eucalipto col.  
rosso marsala  
glossy eucalyptus  
marsala red  
colour



**EF03.G**  
eucalipto  
col. ametista  
glossy  
eucalyptus  
amethyst colour



**EF04.G**  
eucalipto  
col. giallo ocre  
glossy eucalyptus  
ocher yellow  
colour



**EF05.G**  
eucalipto  
col. nero  
glossy  
eucalyptus  
black colour



**EF06.G**  
eucalipto  
col. avorio  
glossy  
eucalyptus  
ivory colour



**EF07.G**  
eucalipto  
col. tortora  
glossy  
eucalyptus  
dove grey colour

struttura in ottone  
brass structure



**ME01**  
bronzato  
bronzed



**ME02**  
bagno oro lucido  
shiny gold  
plated



**ME03**  
satinato  
satin finish



**ME04**  
cromo nero lucido  
shiny black chrome

ripiano in vetro  
glass shelf



**VE01**  
vetro extrach.  
extra-clear  
glass



**VE02**  
vetro bronzato  
bronzed  
glass



**VE03**  
vetro fumé  
smoked  
glass

composizioni | compositions

- |  |                    |
|--|--------------------|
| <b>A.</b> Tavolino con inserto piano in pietra semipreziosa.<br>Coffee table with top insert in semi-precious stone. | <b>€ 16.160,00</b> |
| <b>B.</b> Tavolino con inserto piano in marmo.<br>Coffee table with top insert in marble.                            | <b>€ 8.140,00</b>  |
| <b>C.</b> Tavolino con piano in essenza di legno lucida a scelta.<br>Coffee in a choice of glossy woods.             | <b>€ 6.480,00</b>  |

Altre finiture disponibili su richiesta. | Other finishes available upon request.

# I RODODENDRI

## TAVOLINO ALTO | SMALL TABLE

by Fabio Crippa & Joe Gentile

dimensioni | dimensions  
peso | weight  
volume | volume

Ø55 x H66 cm  
28 kg  
0,32 m<sup>3</sup>

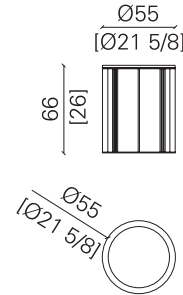

Tavolino alto rotondo con struttura in ottone in finitura bronzata e cornice piano in erable lucido color blu cobalto. Inserto piano in pietra semipreziosa Labradorite con anello in ottone in finitura bronzata.

Small round side table with bronzed brass structure and top frame in glossy cobalt blue maple. Top insert in Labradorite semi-precious stone, with bronzed brass ring.

### finiture | finishes

**A.** inserto piano in pietra semipreziosa  
top insert in semi-precious stone



**PS01**  
Labradorite

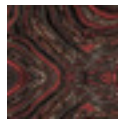

**PS02**  
Ferro Tigrato  
Tiger Iron



**PS03**  
Ametista  
Amethyst



**PS04**  
Occhio di Tigre  
Tiger's Eye

**B.** inserto piano in marmo  
top insert in marble



**MA.C01**  
Azul Bahia



**MA.C02**  
Rosso Lepanto

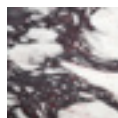

**MA.C03**  
Calacatta Viola

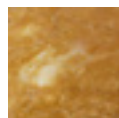

**MA.C04**  
Giallo Siena



**MA.N01**  
Nero Marquina

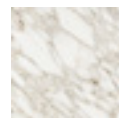

**MA.B01**  
Calacatta  
Vagli Oro



**MA.T02**  
Bronze Amani

cornice piano in erable lucido  
top frame in glossy maple



**ER01.G**  
erable lucido  
blu cobalto  
glossy maple  
cobalt blue



**ER02.G**  
erable lucido  
rosso marsala  
glossy maple  
marsala red

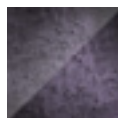

**ER03.G**  
erable lucido  
ametista  
glossy maple  
amethyst

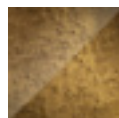

**ER04.G**  
erable lucido  
giallo oca  
glossy maple  
ocher yellow



**ER05.G**  
erable lucido  
col. nero  
glossy maple  
black colour



**ER06.G**  
erable lucido  
col. avorio  
glossy maple  
ivory colour

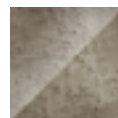

**ER07.G**  
erable lucido  
col. tortora  
glossy maple  
dove grey colour

cornice piano in eucalipto frisé lucido  
top frame in glossy frisé eucalyptus



**EF01.G**  
eucalipto  
col. blu cobalto  
glossy eucalyptus  
cobalt blue colour



**EF02.G**  
eucalipto col.  
rosso marsala  
glossy eucalyptus  
marsala red  
colour



**EF03.G**  
eucalipto  
col. ametista  
glossy eucalyptus  
amethyst colour



**EF04.G**  
eucalipto  
col. giallo oca  
glossy eucalyptus  
ocher yellow  
colour



**EF05.G**  
eucalipto  
col. nero  
glossy eucalyptus  
black colour



**EF06.G**  
eucalipto  
col. avorio  
glossy eucalyptus  
ivory colour

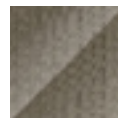

**EF07.G**  
eucalipto  
col. tortora  
glossy eucalyptus  
dove grey colour

Altre finiture disponibili su richiesta. | Other finishes available upon request.

# I RODODENDRI

## TAVOLINO ALTO | SMALL TABLE

prezzo | price

finiture | finishes

**C.** piano in erable lucido  
top in glossy maple



**ER01.G**  
erable lucido  
blu cobalto  
glossy maple  
cobalt blue

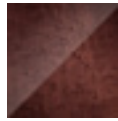

**ER02.G**  
erable lucido  
rosso marsala  
glossy maple  
marsala red

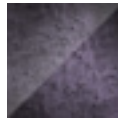

**ER03.G**  
erable lucido  
ametista  
glossy maple  
amethyst

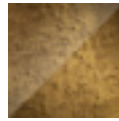

**ER04.G**  
erable lucido  
giallo ocra  
glossy maple  
ocher yellow



**ER05.G**  
erable lucido  
col. nero  
glossy maple  
black colour

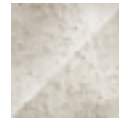

**ER06.G**  
erable lucido  
col. avorio  
glossy maple  
ivory colour



**ER07.G**  
erable lucido  
col. tortora  
glossy maple  
dove grey  
colour

**D.** piano in eucalipto  
frisè lucido  
top in glossy frisè  
eucalyptus



**EF01.G**  
eucalipto  
col. blu cobalto  
glossy eucalyptus  
cobalt blue colour



**EF02.G**  
eucalipto col.  
rosso marsala  
glossy eucalyptus  
marsala red  
colour



**EF03.G**  
eucalipto  
col. ametista  
glossy  
eucalyptus  
amethyst colour



**EF04.G**  
eucalipto  
col. giallo ocra  
glossy eucalyptus  
ocher yellow  
colour



**EF05.G**  
eucalipto  
col. nero  
glossy  
eucalyptus  
black colour



**EF06.G**  
eucalipto  
col. avorio  
glossy  
eucalyptus  
ivory colour



**EF07.G**  
eucalipto  
col. tortora  
glossy  
eucalyptus  
dove grey colour

struttura in ottone  
brass structure



**ME01**  
bronzato  
bronzed



**ME02**  
bagno oro lucido  
shiny gold  
plated



**ME03**  
satinato  
satin finish



**ME04**  
cromo nero lucido  
shiny black chrome

composizioni | compositions

**A.** Tavolino con inserto piano in pietra semipreziosa.  
Coffee table with top insert in semi-precious stone.

€ 9.650,00

**B.** Tavolino con inserto piano in marmo.  
Coffee table with top insert in marble.

€ 6.220,00

**C.** Tavolino con piano in essenza di legno lucida a scelta.  
Coffee table in a choice of glossy woods.

€ 5.380,00

Altre finiture disponibili su richiesta. | Other finishes available upon request.

# I RODODENDRI

## CONSOLE | CONSOLE

by Fabio Crippa & Joe Gentile

dimensioni | dimensions L120 x P40 x H88 cm  
 peso | weight 60 kg  
 volume | volume 0,65 m<sup>3</sup>

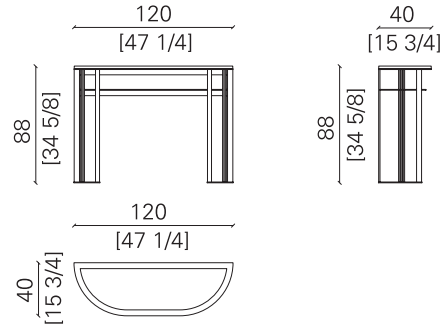

Consolle con struttura in ottone in finitura bronzata e cornice piano in erable lucido color blu cobalto. Inserto piano in pietra semipreziosa Labradorite con anello in ottone in finitura bronzata. Ripiano in vetro bronzato temperato.

Console with bronzed brass structure and top frame in glossy cobalt blue maple. Top insert in Labradorite semi-precious stone, with bronzed brass ring. Tempered bronzed glass shelf.

### finiture | finishes

**A.** inserto piano in pietra semipreziosa  
top insert in semi-precious stone



**PS01**  
Labradorite



**PS02**  
Ferro Tigrato  
Tiger Iron



**PS03**  
Ametista  
Amethyst



**PS04**  
Occhio di Tigre  
Tiger's Eye

**B.** inserto piano in marmo  
top insert in marble



**MA.C01**  
Azul Bahia



**MA.C02**  
Rosso Lepanto

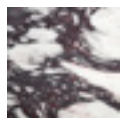

**MA.C03**  
Calacatta Viola

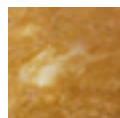

**MA.C04**  
Giallo Siena



**MA.N01**  
Nero Marquina

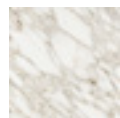

**MA.B01**  
Calacatta  
Vagli Oro



**MA.T02**  
Bronze Amani

cornice piano in erable lucido  
top frame in glossy maple



**ER01.G**  
erable lucido  
blu cobalto  
glossy maple  
cobalt blue

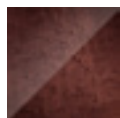

**ER02.G**  
erable lucido  
rosso marsala  
glossy maple  
marsala red

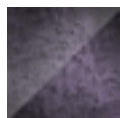

**ER03.G**  
erable lucido  
ametista  
glossy maple  
amethyst

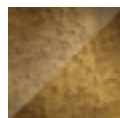

**ER04.G**  
erable lucido  
giallo oca  
glossy maple  
ocher yellow



**ER05.G**  
erable lucido  
col. nero  
glossy maple  
black colour

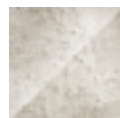

**ER06.G**  
erable lucido  
col. avorio  
glossy maple  
ivory colour

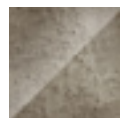

**ER07.G**  
erable lucido  
col. tortora  
glossy maple  
dove grey colour

cornice piano in eucalipto frisé lucido  
top frame in glossy frisé eucalyptus



**EF01.G**  
eucalipto  
col. blu cobalto  
glossy eucalyptus  
cobalt blue colour



**EF02.G**  
eucalipto col.  
rosso marsala  
glossy eucalyptus  
marsala red  
colour



**EF03.G**  
eucalipto  
col. ametista  
glossy eucalyptus  
amethyst colour



**EF04.G**  
eucalipto  
col. giallo oca  
glossy eucalyptus  
ocher yellow  
colour



**EF05.G**  
eucalipto  
col. nero  
glossy eucalyptus  
black colour



**EF06.G**  
eucalipto  
col. avorio  
glossy eucalyptus  
ivory colour

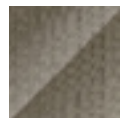

**EF07.G**  
eucalipto  
col. tortora  
glossy eucalyptus  
dove grey colour

Altre finiture disponibili su richiesta. | Other finishes available upon request.

# I RODODENDRI

## CONSOLLE | CONSOLE

prezzo | price

finiture | finishes

**C.** piano in erable lucido  
top in glossy maple



**ER01.G**  
erable lucido  
blu cobalto  
glossy maple  
cobalt blue



**ER02.G**  
erable lucido  
rosso marsala  
glossy maple  
marsala red



**ER03.G**  
erable lucido  
ametista  
glossy maple  
amethyst

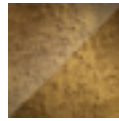

**ER04.G**  
erable lucido  
giallo ocre  
glossy maple  
ocher yellow



**ER05.G**  
erable lucido  
col. nero  
glossy maple  
black colour



**ER06.G**  
erable lucido  
col. avorio  
glossy maple  
ivory colour



**ER07.G**  
erable lucido  
col. tortora  
glossy maple  
dove grey  
colour

**D.** piano in eucalipto  
frisè lucido  
top in glossy frisè  
eucalyptus



**EF01.G**  
eucalipto  
col. blu cobalto  
glossy eucalyptus  
cobalt blue colour



**EF02.G**  
eucalipto col.  
rosso marsala  
glossy eucalyptus  
marsala red  
colour



**EF03.G**  
eucalipto  
col. ametista  
glossy  
eucalyptus  
amethyst colour



**EF04.G**  
eucalipto  
col. giallo ocre  
glossy eucalyptus  
ocher yellow  
colour



**EF05.G**  
eucalipto  
col. nero  
glossy  
eucalyptus  
black colour



**EF06.G**  
eucalipto  
col. avorio  
glossy  
eucalyptus  
ivory colour



**EF07.G**  
eucalipto  
col. tortora  
glossy  
eucalyptus  
dove grey colour

struttura in ottone  
brass structure



**ME01**  
bronzato  
bronzed



**ME02**  
bagno oro lucido  
shiny gold  
plated



**ME03**  
satinato  
satin finish



**ME04**  
cromo nero lucido  
shiny black chrome

ripiano in vetro  
glass shelf



**VE01**  
vetro extrach.  
extra-clear  
glass



**VE02**  
vetro bronzato  
bronzed  
glass



**VE03**  
vetro fumé  
smoked  
glass

composizioni | compositions

**A.** Consolle con inserto piano in pietra semipreziosa.  
Console with top insert in semi-precious stone.

€ 14.720,00

**B.** Consolle con inserto piano in marmo.  
Console with top insert in marble.

€ 6.930,00

**C.** Consolle con piano in essenza di legno lucida a scelta.  
Console in a choice of glossy woods.

€ 5.910,00

Altre finiture disponibili su richiesta. | Other finishes available upon request.

# I RODODENDRI

## TAVOLINO LATERALE | SIDE TABLE

by Fabio Crippa & Joe Gentile

dimensioni | dimensions  
peso | weight  
volume | volume

Ø60 x H48 cm  
11 kg  
0,30 m<sup>3</sup>

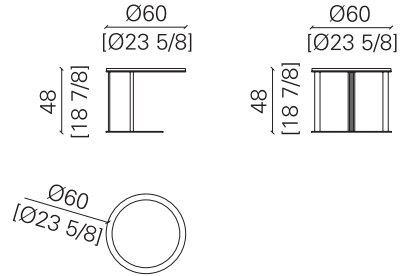

Tavolino laterale rotondo con struttura in ottone in finitura bronzata, piano in erable lucido color blu cobalto.

Round side table with bronzed brass structure and top in glossy cobalt blue maple.

### finiture | finishes

piano in erable lucido  
top in glossy maple



**ER01.G**  
erable lucido  
blu cobalto  
glossy maple  
cobalt blue

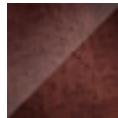

**ER02.G**  
erable lucido  
rosso marsala  
glossy maple  
marsala red

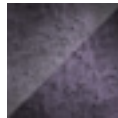

**ER03.G**  
erable lucido  
ametista  
glossy maple  
amethyst

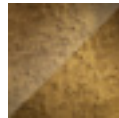

**ER04.G**  
erable lucido  
giallo ocra  
glossy maple  
ocher yellow



**ER05.G**  
erable lucido  
col. nero  
glossy maple  
black colour



**ER06.G**  
erable lucido  
col. avorio  
glossy maple  
ivory colour

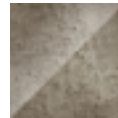

**ER07.G**  
erable lucido  
col. tortora  
glossy maple  
dove grey colour

piano in eucalipto frisé  
lucido  
top is glossy frisé  
eucalyptus



**EF01.G**  
eucalipto  
col. blu cobalto  
glossy eucalyptus  
cobalt blue colour



**EF02.G**  
eucalipto col.  
rosso marsala  
glossy eucalyptus  
marsala red  
colour



**EF03.G**  
eucalipto  
col. ametista  
glossy  
eucalyptus  
amethyst colour



**EF04.G**  
eucalipto  
col. giallo ocra  
glossy eucalyptus  
ocher yellow  
colour



**EF05.G**  
eucalipto  
col. nero  
glossy  
eucalyptus  
black colour



**EF06.G**  
eucalipto  
col. avorio  
glossy  
eucalyptus  
ivory colour

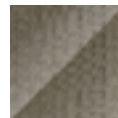

**EF07.G**  
eucalipto  
col. tortora  
glossy  
eucalyptus  
dove grey colour

struttura in ottone  
brass structure



**ME01**  
bronzato  
bronzed



**ME02**  
bagno oro lucido  
shiny gold  
plated



**ME03**  
satinato  
satin finish

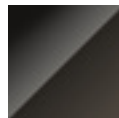

**ME04**  
cromo nero lucido  
shiny black chrome

prezzo | price

€ 4.270,00

### composizioni | compositions

Tavolino con piano in essenza di legno lucida a scelta.  
Coffee table in a choice of glossy woods.



# I LILLA

## TAVOLINO BASSO | COFFEE TABLE

by Fabio Crippa & Joe Gentile

dimensioni | dimensions  
peso | weight  
volume | volume

Ø90 x H37 cm  
25 kg  
0,50 m<sup>3</sup>

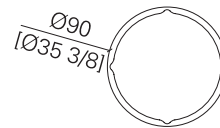
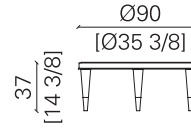

Tavolino basso rotondo con piano in marmo Rainforest Green, struttura in noce americano tinto scuro lucido, anello sottopiano e puntali conificati in ottone in finitura bronzata.

Round coffee table with Rainforest Green marble top, structure in glossy dark American walnut, ring under the top and cone-shaped tips in bronzed brass.

### finiture | finishes

piano in marmo alleggerito  
lightened marble top

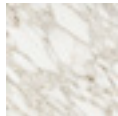

**MA.B01**  
Calacatta  
Vagli Oro

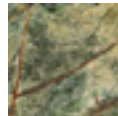

**MA.T03**  
Rainforest  
Green

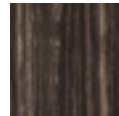

**MA.T01**  
Eramosa

**A.** struttura in noce americano  
lucido  
glossy American walnut  
structure



**NA01.G**  
noce amer.  
scuro lucido  
glossy dark  
American  
walnut



**NA02.G**  
noce amer.  
naturale lucido  
glossy natural  
American  
walnut

**B**



**NA01.M**  
noce amer.  
scuro opaco  
matt dark  
American  
walnut



**NA02L.M**  
noce amer.  
naturale opaco  
matt natural  
American  
walnut

puntali in ottone  
tips in brass



**ME01**  
bronzato  
bronzed



**ME02**  
bagno oro lucido  
shiny gold  
plated



**ME03**  
satinato  
satin finish



**ME04**  
cromo nero lucido  
shiny black chrome

### composizioni | compositions

**A.** Tavolino in finitura noce americano lucido.  
Coffee table in glossy American walnut.

€ 5.460,00

**B.** Tavolino in finitura noce americano opaco.  
Coffee table in matt American walnut.

€ 5.290,00

Altre finiture disponibili su richiesta. | Other finishes available upon request.

# I LILLA

## TAVOLINO MEDIO | MEDIUM TABLE

by Fabio Crippa & Joe Gentile

dimensioni | dimensions  
peso | weight  
volume | volume

Ø60 x H45 cm  
18 kg  
0,27 m<sup>3</sup>

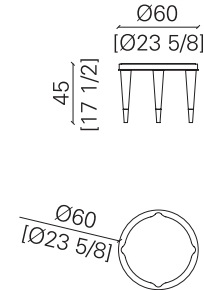

Tavolino basso rotondo con piano in marmo Rainforest Green, struttura in noce americano tinto scuro lucido, anello sottopiano e puntali conificati in ottone in finitura bronzata.

Round coffee table with Rainforest Green marble top, structure in glossy dark American walnut, ring under the top and cone-shaped tips in bronzed brass.

### finiture | finishes

piano in marmo alleggerito  
lightened marble top

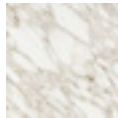

**MA.B01**  
Calacatta  
Vagli Oro

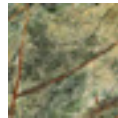

**MA.T03**  
Rainforest  
Green

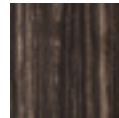

**MA.T01**  
Eramosa

**A.** struttura in noce americano  
lucido  
glossy American walnut  
structure

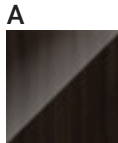

**NA01.G**  
noce amer.  
scuro lucido  
glossy dark  
American  
walnut



**NA02.G**  
noce amer.  
naturale lucido  
glossy natural  
American  
walnut



**NA01.M**  
noce amer.  
scuro opaco  
matt dark  
American  
walnut



**NA02L.M**  
noce amer.  
naturale opaco  
matt natural  
American  
walnut

puntali in ottone  
tips in brass



**ME01**  
bronzato  
bronzed



**ME02**  
bagno oro lucido  
shiny gold  
plated



**ME03**  
satinato  
satin finish



**ME04**  
cromo nero lucido  
shiny black chrome

### composizioni | compositions

**A.** Tavolino in finitura noce americano lucido.  
Coffee table in glossy American walnut.

€ 4.200,00

**B.** Tavolino in finitura noce americano opaco.  
Coffee table in matt American walnut.

€ 4.030,00

prezzo | price

Altre finiture disponibili su richiesta. | Other finishes available upon request.

# I LILLA

## TAVOLINO ALTO | SMALL TABLE

by Fabio Crippa & Joe Gentile

dimensioni | dimensions  
peso | weight  
volume | volume

Ø55 x H61 cm  
16 kg  
0,30 m<sup>3</sup>

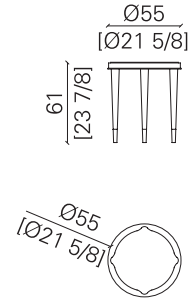

Tavolino alto rotondo con piano in marmo Rainforest Green, struttura in noce americano tinto scuro lucido, anello sottopiano e puntali conificati in ottone in finitura bronzata.

Small round table with Rainforest Green marble top, structure in glossy dark American walnut, ring under the top and cone-shaped tips in bronzed brass.

### finiture | finishes

piano in marmo alleggerito  
lightened marble top

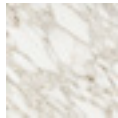

**MA.B01**  
Calacatta  
Vagli Oro

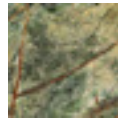

**MA.T03**  
Rainforest  
Green

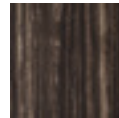

**MA.T01**  
Eramosa

**A.** struttura in noce americano  
lucido  
glossy American walnut  
structure

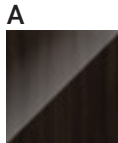

**NA01.G**  
noce amer.  
scuro lucido  
glossy dark  
American  
walnut



**NA02.G**  
noce amer.  
naturale lucido  
glossy natural  
American  
walnut

**B**



**NA01.M**  
noce amer.  
scuro opaco  
matt dark  
American  
walnut



**NA02L.M**  
noce amer.  
naturale opaco  
matt natural  
American  
walnut

puntali in ottone  
tips in brass



**ME01**  
bronzato  
bronzed



**ME02**  
bagno oro lucido  
shiny gold  
plated



**ME03**  
satinato  
satin finish



**ME04**  
cromo nero lucido  
shiny black chrome

### composizioni | compositions

**A.** Tavolino in finitura noce americano lucido.  
Coffee table in glossy American walnut.

€ 4.080,00

**B.** Tavolino in finitura noce americano opaco.  
Coffee table in matt American walnut.

€ 3.910,00

Altre finiture disponibili su richiesta. | Other finishes available upon request.

# I NOCCIOLI

## TAVOLINO BASSO | COFFEE TABLE

by Fabio Crippa & Joe Gentile

dimensioni | dimensions  
peso | weight  
volume | volume

Ø90 x H40 cm  
25 kg  
0,50 m<sup>3</sup>

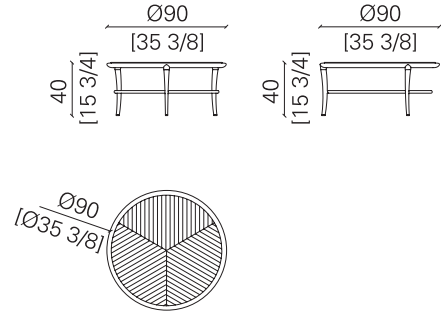

Tavolino basso rotondo con struttura in massello di noce americano naturale opaco con piano intarsiato in lastra. Ripiano in vetro bronzato temperato. Puntali in ottone in finitura satinata.

Round coffee table with solid matt natural American walnut frame, and inlaid top. Tempered bronzed glass shelf. Tips in brass with satin finish.

### finiture | finishes

struttura in noce americano  
opaco  
matt American walnut structure



**NA01.M**  
noce amer.  
scuro opaco  
matt dark  
American  
walnut



**NA02L.M**  
noce amer.  
naturale opaco  
matt natural  
American  
walnut

ripiano in vetro  
glass shelf



**VE01**  
vetro extrach.  
extra-clear  
glass



**VE02**  
vetro bronzato  
bronzed  
glass



**VE03**  
vetro fumé  
smoked  
glass

puntali in ottone  
tips in brass



**ME02**  
bagno oro lucido  
shiny gold  
plated



**ME03**  
satinato  
satin finish

### composizioni | compositions

Finitura come da immagine.  
Finish as shown in image.

prezzo | price

€ 3.670,00

Altre finiture disponibili su richiesta. | Other finishes available upon request.

# I NOCCIOLI

## TAVOLINO PICCOLO | SMALL TABLE

by Fabio Crippa & Joe Gentile

dimensioni | dimensions  
peso | weight  
volume | volume

Ø55 x H55cm  
17 kg  
0,30 m<sup>3</sup>

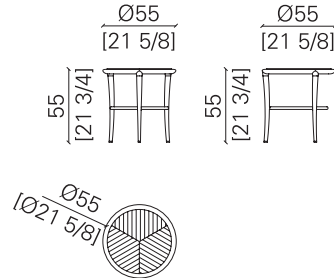

Tavolino piccolo rotondo con struttura in massello di noce americano naturale opaco con piano intarsiato in lastra. Ripiano in vetro bronzato temperato. Puntali in ottone in finitura satinata.

Small round table with solid matt natural American walnut frame, and inlaid top. Tempered bronzed glass shelf. Tips in brass with satin finish.

### finiture | finishes

struttura in noce americano  
opaco  
matt American walnut structure



**NA01.M**  
noce amer.  
scuro opaco  
matt dark  
American  
walnut

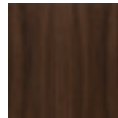

**NA02L.M**  
noce amer.  
naturale opaco  
matt natural  
American  
walnut

ripiano in vetro  
glass shelf



**VE01**  
vetro extrach.  
extra-clear  
glass



**VE02**  
vetro bronzato  
bronzed  
glass



**VE03**  
vetro fumé  
smoked  
glass

puntali in ottone  
tips in brass



**ME02**  
bagno oro lucido  
shiny gold  
plated



**ME03**  
satinato  
satin finish

### composizioni | compositions

Finitura come da immagine.  
Finish as shown in image.

prezzo | price

€ 2.800,00

Altre finiture disponibili su richiesta. | Other finishes available upon request.

GLI OLMI

TAVOLINO BASSO QUADRATO | SQUARE COFFEE TABLE

by Fabio Crippa & Joe Gentile

dimensioni | dimensions L95 x P95 x H41 cm  
 peso | weight 70 kg  
 volume | volume 0,56 m<sup>3</sup>

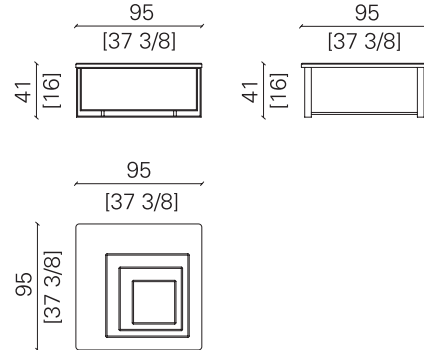

Tavolino basso quadrato con struttura in ottone in finitura cromo nero lucido e piano in marmo Nero Marquina con intarsio bianco in contrasto.

Square coffee table with shiny black chromed brass structure, and top in Nero Marquina marble, with contrasting white inlay.

finiture | finishes

piano in marmo alleggerito con inserto in contrasto  
 lightened marble top with contrasting inserts

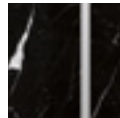

**MA.N01**  
 Nero Marquina  
 con inserto  
 bianco  
 with white insert

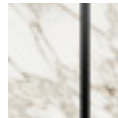

**MA.B01**  
 Calacatta  
 Vagli Oro con  
 inserto nero  
 with black insert

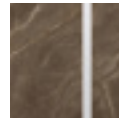

**MA.T02**  
 Bronze Amani  
 con inserto  
 bianco  
 with white insert

struttura in ottone  
 brass structure



**ME01**  
 bronzato  
 bronzed



**ME02**  
 bagno oro  
 lucido  
 shiny gold  
 plated



**ME03**  
 satinato  
 satin finish



**ME04**  
 cromo nero lucido  
 shiny black chrome

prezzo | price

composizioni | compositions

Finitura come da immagine.  
 Finish as shown in image.

€ 6.480,00

Altre finiture disponibili su richiesta. | Other finishes available upon request.

**GLI OLMI**

**TAVOLINO BASSO RETTANGOLARE | RECTANGULAR COFFEE TABLE**

by Fabio Crippa & Joe Gentile

dimensioni | dimensions L140 x P80 x H41 cm  
 peso | weight 77 kg  
 volume | volume 0,70 m<sup>3</sup>

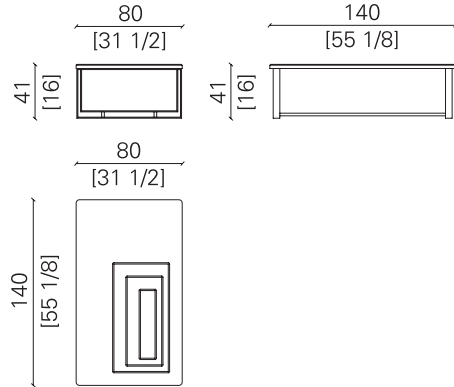

Tavolino basso rettangolare con struttura in ottone in finitura cromo nero lucido e piano in marmo Nero Marquina con intarsio bianco in contrasto.

Rectangular coffee table with shiny black chromed brass structure, and top in Nero Marquina marble, with contrasting white inlay.

finiture | finishes

piano in marmo alleggerito con inserto in contrasto  
 lightened marble top with contrasting inserts

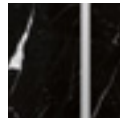

**MA.N01**  
 Nero Marquina  
 con inserto  
 bianco  
 with white insert

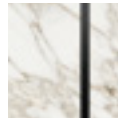

**MA.B01**  
 Calacatta  
 Vagli Oro con  
 inserto nero  
 with black insert

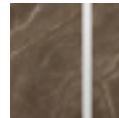

**MA.T02**  
 Bronze Amani  
 con inserto  
 bianco  
 with white insert

struttura in ottone  
 brass structure



**ME01**  
 bronzato  
 bronzed



**ME02**  
 bagno oro  
 lucido  
 shiny gold  
 plated



**ME03**  
 satinato  
 satin finish



**ME04**  
 cromo nero lucido  
 shiny black chrome

prezzo | price

composizioni | compositions

Finitura come da immagine.  
 Finish as shown in image.

€ 7.980,00

Altre finiture disponibili su richiesta. | Other finishes available upon request.

**GLI OLMI**

**TAVOLINO ALTO | SMALL TABLE**

by Fabio Crippa & Joe Gentile

dimensioni | dimensions L45 x P45 x H65 cm  
 peso | weight 40 kg  
 volume | volume 0,23 m<sup>3</sup>

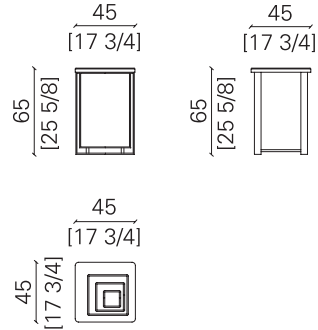

Tavolino alto con struttura in ottone in finitura cromo nero lucido e piano in marmo Nero Marquina con intarsio bianco in contrasto.

Small table with shiny black chromed brass structure, and top in Nero Marquina marble, with contrasting white inlay.

finiture | finishes

piano in marmo alleggerito con inserto in contrasto  
 lightened marble top with contrasting inserts

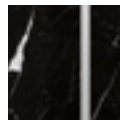

**MA.N01**  
 Nero Marquina  
 con inserto  
 bianco  
 with white insert

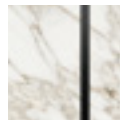

**MA.B01**  
 Calacatta  
 Vagli Oro con  
 inserto nero  
 with black insert

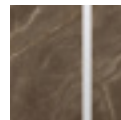

**MA.T02**  
 Bronze Amani  
 con inserto  
 bianco  
 with white insert

struttura in ottone  
 brass structure



**ME01**  
 bronzato  
 bronzed



**ME02**  
 bagno oro  
 lucido  
 shiny gold  
 plated



**ME03**  
 satinato  
 satin finish

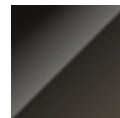

**ME04**  
 cromo nero lucido  
 shiny black chrome

prezzo | price

composizioni | compositions

Finitura come da immagine.  
 Finish as shown in image.

€ 4.380,00

Altre finiture disponibili su richiesta. | Other finishes available upon request.



# L'ALBICOCCO

## POUF | POUF





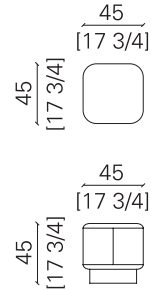

by Fabio Crippa & Joe Gentile

dimensioni | dimensions L45 x P45 x H45 cm  
 peso | weight 6 kg  
 volume | volume 0,17 m<sup>3</sup>

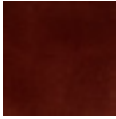

Pouf imbottito in velluto con profili in tinta. Basamento in ottone in finitura bronzata.

Pouf upholstered in velvet with matching profile. Base in bronzed brass.

finiture   finishes		quantità   quantity	prezzo   price
<b>A.</b> imbottitura in velluto con profilo in tinta upholstered in velvet with matching profile	 + altri colori + other colours	1,5 mtl	
	<b>LPAL012</b> velluto velvet		
<b>B.</b> imbottitura in pelle con profilo in tinta upholstered in leather with matching profile	 + altri colori + other colours	3 mq	
	<b>ET5002</b> pelle leather		
basamento in ottone base in brass	 <b>ME01</b> bronzato bronzed		
	 <b>ME02</b> bagno oro lucido shiny gold plated		
	 <b>ME03</b> satinato satin finish		
	 <b>ME04</b> cromo nero lucido shiny black chrome		
<b>A.</b> Pouf imbottito in tessuto. Pouf upholstered in fabric.		€	1.600,00
<b>B.</b> Pouf imbottito in pelle. Pouf upholstered in leather.		€	1.870,00

Altre finiture disponibili su richiesta. | Other finishes available upon request.



**LO STUDIO**  
THE STUDY

# IL LECCIO

## SCRITTOIO | WRITING DESK



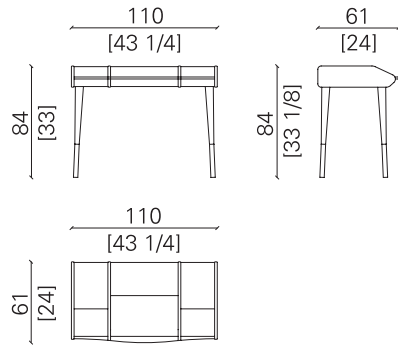

by Fabio Crippa & Joe Gentile

dimensioni | dimensions L110 x P61 x H84 cm  
 peso | weight 70 kg  
 volume | volume 0,80 m<sup>3</sup>

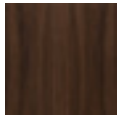

Scrivania con struttura in multistrato di pioppo impiallacciato in noce americano, gambe ed inserti in massello di noce americano naturale opaco e rivestimento in pelle. Puntali in ottone in finitura bagno oro lucido. Cassetti con chiusura a serranda.

Writing desk with multi-ply poplar structure, veneered in American walnut, with natural matt solid American walnut legs and inserts, and upholstered in leather. Tips in brass with shiny gold plated finish. Drawers with roller shutter closers.

finiture   finishes		quantità   quantity		
<b>A.</b> struttura in noce americano lucido glossy American walnut structure				
	<b>NA01.G</b> noce amer. scuro lucido glossy dark American walnut	<b>NA02.G</b> noce amer. naturale lucido glossy natural American walnut		
	<b>B.</b> struttura in noce americano opaco matt American walnut structure			
		<b>NA01.M</b> noce amer. scuro opaco matt dark American walnut	<b>NA02.L.M</b> noce amer. naturale opaco matt natural American walnut	
rivestimento in pelle upholstery in leather		+ altri colori + other colours	4 mq	
	<b>ET5006</b> pelle leather			

Altre finiture disponibili su richiesta. | Other finishes available upon request.

## IL LECCIO

### SCRITTOIO | WRITING DESK

prezzo | price

#### finiture | finishes

puntali in ottone  
tips in brass



**ME01**  
bronzato  
bronzed



**ME02**  
bagno oro  
lucido  
shiny gold  
plated



**ME03**  
satinato  
satin finish



**ME04**  
cromo nero  
lucido  
shiny black  
chrome

#### composizioni | compositions

- A.** Scrivitoio in noce americano lucido.  
Writing desk in glossy American walnut.
- B.** Scrivitoio in noce americano opaco.  
Writing desk in matt American walnut.

€ 16.340,00

€ 15.640,00

Altre finiture disponibili su richiesta. | Other finishes available upon request.

# IL CEDRO

## SCRIVANIA VARIANTE 1 | DESK VARIANT 1

by Fabio Crippa & Joe Gentile

dimensioni | dimensions L220 x P100 x H75 cm  
 peso | weight 110 kg  
 volume | volume 2,15 m<sup>3</sup>

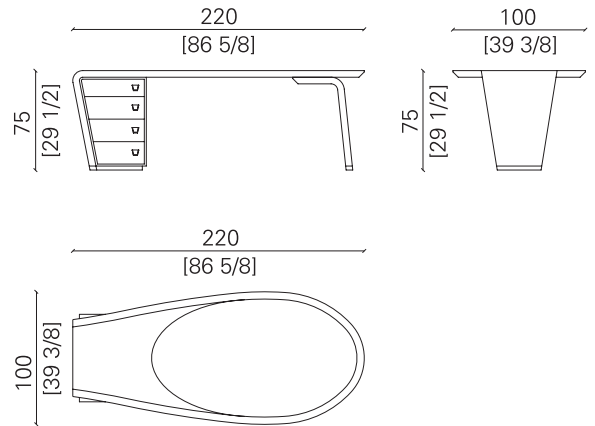

Scrivania con struttura e cassetti in multistrato di pioppo impiallacciato in noce americano tinto scuro lucido, cornici perimetrali piano e spalle in massello di noce americano tinto scuro lucido. Rivestimento piano e spallette laterali in pelle con cuciture in tinta. Cassettiera laterale rivestita con dettagli in pelle con cassetti con fondo in pelle con cucitura in tinta. Basamento e dettagli maniglie in ottone in finitura bronzata.

Desk with multi-ply poplar structure veneered in glossy dark American walnut, top edging and sides in solid glossy dark American walnut. Top and sides upholstery in leather with matching stitching. Side chest of drawers clad with leather detailing, and drawer bottoms lined in leather with matching stitching. Base and handle details in bronzed brass.

### finiture | finishes

### quantità | quantity

**A.** struttura in noce americano lucido  
 glossy American walnut structure

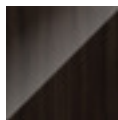

**NA01.G**  
 noce amer. scuro lucido  
 glossy dark American walnut



**NA02.G**  
 noce amer. naturale lucido  
 glossy natural American walnut

**B.** struttura in noce americano opaco  
 matt American walnut structure



**NA01.M**  
 noce amer. scuro opaco  
 matt dark American walnut

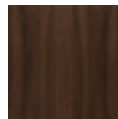

**NA02L.M**  
 noce amer. naturale opaco  
 matt natural American walnut

rivestimento in pelle  
 upholstery in leather

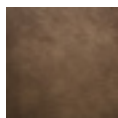

**ET5018**  
 pelle  
 leather

+ altri colori  
 + other colours

10 mq

Altre finiture disponibili su richiesta. | Other finishes available upon request.

# IL CEDRO

## SCRIVANIA VARIANTE 1 | DESK VARIANT 1

prezzo | price

### finiture | finishes

fondo cassetti in pelle con cucitura in tinta  
drawer bottoms in leather with matching stitching

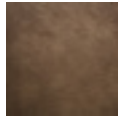

+ altri colori  
+ other colours

**ET5018**  
pelle  
leather

basamento e dettagli maniglie in ottone  
base and handle details in brass



**ME01**  
bronzato  
bronzed



**ME02**  
bagno oro  
lucido  
shiny gold  
plated



**ME03**  
satinato  
satin finish



**ME04**  
cromo nero  
lucido  
shiny black  
chrome

### composizioni | compositions

**A.** Scrivania in finitura noce americano lucido.  
Desk finished in glossy American walnut.

€ 21.510,00

**B.** Scrivania in finitura noce americano opaco.  
Desk finished in matt American walnut.

€ 20.830,00

Altre finiture disponibili su richiesta. | Other finishes available upon request.

## IL CEDRO

### SCRIVANIA VARIANTE 2 | DESK VARIANT 2

by Fabio Crippa & Joe Gentile

dimensioni | dimensions L220 x P165 x H75 cm  
 peso | weight 175 kg  
 volume | volume 3,50 m<sup>3</sup>

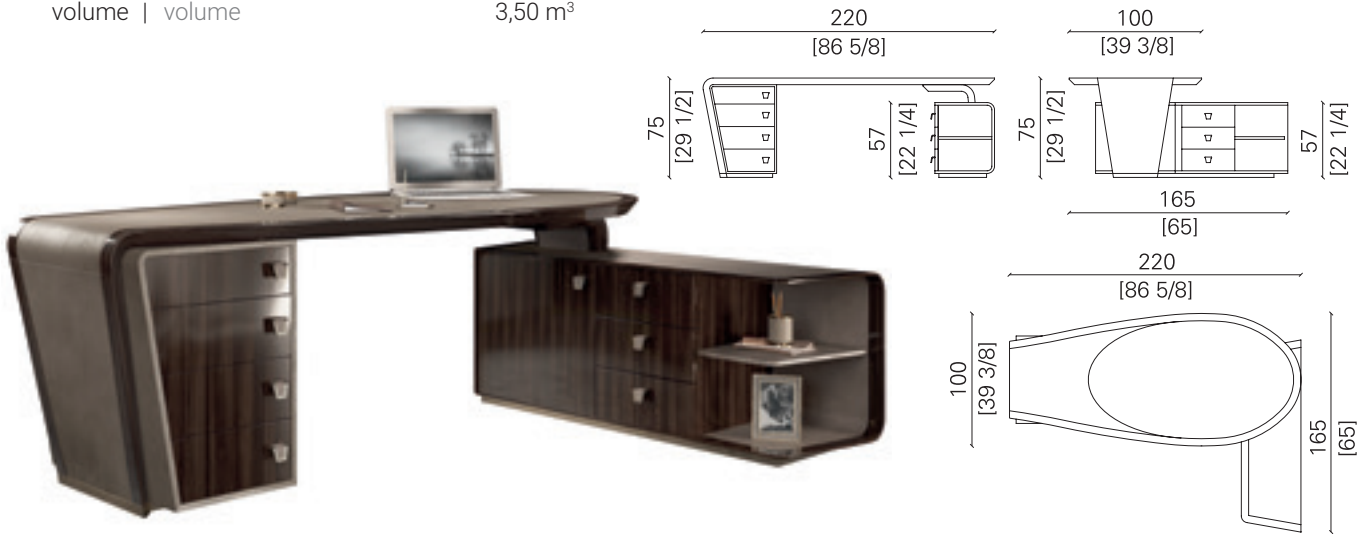

Scrivania con struttura e cassetti in mutistrato di pioppo impiallacciato in noce americano tinto scuro lucido, cornici perimetrali piano e spalle in massello di noce americano tinto scuro lucido. Rivestimento piano e spallette laterali in pelle con cuciture in tinta. Cassettiera laterale rivestita con dettagli in pelle con cassetti con fondo in pelle con cucitura in tinta. Allunga laterale con anta e cassetti in noce americano. Ripiani laterali rivestiti in pelle. Basamento e dettagli maniglie in ottone in finitura bronzata.

Desk with multi-ply poplar structure veneered in glossy dark American walnut, top edging and sides in solid glossy dark American walnut. Top and sides upholstery in leather with matching stitching. Side chest of drawers clad with leather detailing, and drawer bottoms lined in leather with matching stitching. Side extension with door and drawers in American walnut. Side shelves upholstered in leather. Base and handle details in bronzed brass.

finiture | finishes

quantità | quantity

**A.** struttura in noce americano lucido  
 glossy American walnut structure

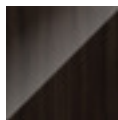

**NA01.G**  
 noce amer. scuro lucido  
 glossy dark American walnut



**NA02.G**  
 noce amer. naturale lucido  
 glossy natural American walnut

**B.** struttura in noce americano opaco  
 matt American walnut structure



**NA01.M**  
 noce amer. scuro opaco  
 matt dark American walnut

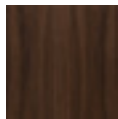

**NA02.L.M**  
 noce amer. naturale opaco  
 matt natural American walnut

rivestimento in pelle  
 upholstery in leather

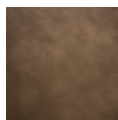

**ET5018**  
 pelle  
 leather

+ altri colori  
 + other colours

15,5 mq

Altre finiture disponibili su richiesta. | Other finishes available upon request.



## IL CEDRO

### SCRIVANIA VARIANTE 2 | DESK VARIANT 2

prezzo | price

#### finiture | finishes

fondo cassetti in pelle con cucitura in tinta  
drawer bottoms in leather with matching stitching

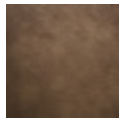

+ altri colori  
+ other colours

**ET5018**  
pelle  
leather

basamento e dettagli maniglie in ottone  
base and handle details in brass



**ME01**  
bronzato  
bronzed



**ME02**  
bagno oro  
lucido  
shiny gold  
plated



**ME03**  
satinato  
satin finish



**ME04**  
cromo nero  
lucido  
shiny black  
chrome

#### composizioni | compositions

**A.** Scrivania e cassettera in finitura noce americano lucido.  
Desk and chest of drawers finished in glossy American walnut.

€ 29.620,00

**B.** Scrivania e cassettera in finitura noce americano opaco.  
Desk and chest of drawers finished in matt American walnut.

€ 28.430,00

Altre finiture disponibili su richiesta. | Other finishes available upon request.

# IL CARPINO

## LIBRERIA VARIANTE 1 | BOOKCASE VARIANT 1

by Fabio Crippa & Joe Gentile

dimensioni | dimensions L100 x P45 x H200 cm  
 peso | weight 160 kg  
 volume | volume 1,30 m<sup>3</sup>

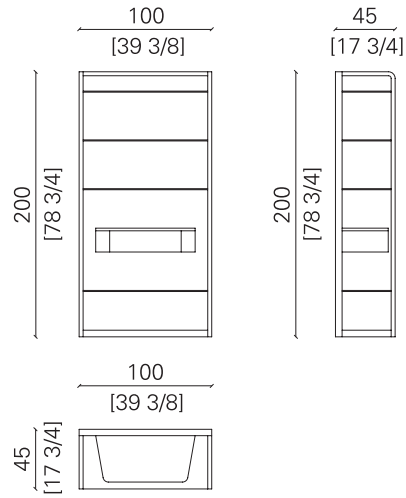

Libreria a giorno con struttura in ottone in finitura bronzata e schienale retroilluminato in onice Verde Pakistano. Ripiani in vetro bronzato temperato. Rivestimento cassetto sospeso, profili frontali e base in cuoietto con cuciture in tinta. Sensore di accensione laterale.

Open bookcase with bronzed brass structure and backlit back panel in Pakistan Green Onyx. Tempered bronzed glass shelves. Suspended drawer front and base profiles upholstered in leatherette with matching stitching. Side light switch sensor.

### finiture | finishes

schienale in onice  
back panel in onyx

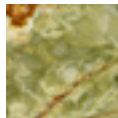

**OX01**  
Onice Verde  
Pakistano  
Pakistan Green  
Onyx



**OX02**  
Onice Miele  
Honey Onyx



**OX04**  
Onice Bianco  
White Onyx

rivestimento cassetto e base  
drawer and base upholstery

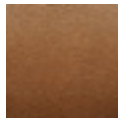

**CU05**  
cuoietto  
col. cuoio  
leather colour  
leatherette



**CU04**  
cuoietto  
col. nero  
black colour  
leatherette



**CU01**  
cuoietto  
col. avorio  
ivory colour  
leatherette

struttura in ottone  
brass structure



**ME01**  
bronzato  
bronzed



**ME02**  
bagno oro  
lucido  
shiny gold  
plated



**ME03**  
satinato  
satin finish



**ME04**  
cromo nero  
lucido  
shiny black  
chrome

Altre finiture disponibili su richiesta. | Other finishes available upon request.

## IL CARPINO

LIBRERIA VARIANTE 1 | BOOKCASE VARIANT 1

prezzo | price

finiture | finishes

ripiani in vetro  
glass shelves



**VE01**  
vetro extrach.  
extra-clear  
glass



**VE02**  
vetro bronzato  
bronzed  
glass



**VE03**  
vetro fumé  
smoked  
glass

composizioni | compositions

Libreria con retroilluminazione a LED.  
Bookcase with LED backlighting.

€ 16.890,00

Libreria senza retroilluminazione a LED.  
Bookcase without LED backlighting.

€ 14.270,00

Altre finiture disponibili su richiesta. | Other finishes available upon request.

# IL CARPINO

## LIBRERIA VARIANTE 2 | BOOKCASE VARIANT 2

by Fabio Crippa & Joe Gentile

dimensioni | dimensions L100 x P45 x H200 cm  
 peso | weight 140 kg  
 volume | volume 1,30 m<sup>3</sup>

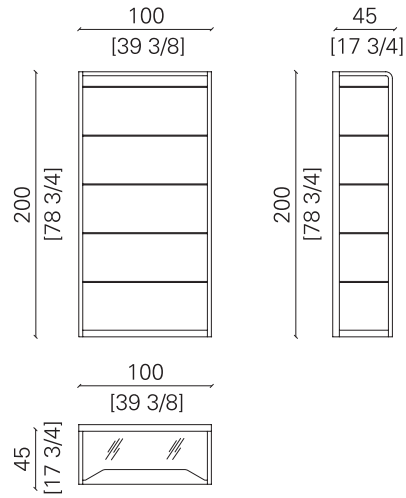

Libreria a giorno con struttura in ottone in finitura bronzata e schienale retroilluminato in onice Verde Pakistano. Ripiani in vetro bronzato temperato. Rivestimento profili frontali e base in cuoietto con cuciture in tinta. Sensore di accensione laterale.

Open bookcase with bronzed brass structure and backlit back panel in Pakistan Green Onyx. Tempered bronzed glass shelves. Front and base profiles upholstered in leatherette with matching stitching. Side light switch sensor.

### finiture | finishes

schienale in onice  
back panel in onyx



**OX01**  
Onice Verde  
Pakistano  
Pakistan Green  
Onyx



**OX02**  
Onice Miele  
Honey Onyx



**OX04**  
Onice Bianco  
White Onyx

rivestimento cassetto e base  
drawer and base upholstery

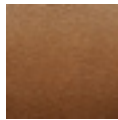

**CU05**  
cuoietto  
col. cuoio  
leather colour  
leatherette



**CU04**  
cuoietto  
col. nero  
black colour  
leatherette



**CU01**  
cuoietto  
col. avorio  
ivory colour  
leatherette

struttura in ottone  
brass structure



**ME01**  
bronzato  
bronzed



**ME02**  
bagnio oro  
lucido  
shiny gold  
plated



**ME03**  
satinato  
satin finish



**ME04**  
cromo nero  
lucido  
shiny black  
chrome

Altre finiture disponibili su richiesta. | Other finishes available upon request.

## IL CARPINO

LIBRERIA VARIANTE 2 | BOOKCASE VARIANT 2

prezzo | price

finiture | finishes

ripiani in vetro  
glass shelves

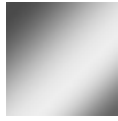

**VE01**  
vetro extrach.  
extra-clear  
glass



**VE02**  
vetro bronzato  
bronzed  
glass



**VE03**  
vetro fumé  
smoked  
glass

composizioni | compositions

Libreria con retroilluminazione a LED.  
Bookcase with LED backlighting.

€ 14.560,00

Libreria senza retroilluminazione a LED.  
Bookcase without LED backlighting.

€ 11.940,00

Altre finiture disponibili su richiesta. | Other finishes available upon request.



**LE FINITURE**  
FINISHES

Trattandosi di materie prime naturali, i segni, le imperfezioni, le disomogeneità e le differenze di colore che si possono riscontrare sulla superficie di prodotti finiti non sono da considerarsi difetti, bensì elementi distintivi che ne esaltano la bellezza e la peculiarità.

Tutte le immagini di finiture e i rispettivi colori riportati all'interno del presente listino riproducono il più fedelmente possibile le caratteristiche dei diversi materiali, ma rimangono puramente indicativi per motivi di rappresentazione e di stampa digitale. Anche gli eventuali campioni forniti per la vendita sono indicativi e possono variare in base alle caratteristiche specifiche del prodotto.

Le finiture disponibili si riferiscono esclusivamente a quelle riportate nel nostro catalogo. Qualsiasi richiesta aggiuntiva, se tecnicamente realizzabile, va comunicata e concordata con l'azienda prima della conferma d'ordine.

Per la corretta pulizia delle superfici è consigliato l'utilizzo di un panno morbido, evitando di impiegare l'utilizzo di qualsiasi detergente. Evitare l'esposizione diretta al sole e a fonti di calore.

Tutti le finiture riportano un codice che indica il riferimento interno dell'articolo.

Per evitare errori nell'evasione degli ordini, si raccomanda di attenersi con precisione alla descrizione dei modelli presenti a listino, indicando esattamente articolo, misure, quantità, codice delle finiture ed eventuali richieste aggiuntive. Per tale motivo l'azienda si riserva di comunicare al cliente l'eventuale fattibilità tecnica e stilistica del prodotto scelto, proponendo eventuali soluzioni adottabili in alternativa a quanto richiesto.

Since natural raw materials are used, marks, imperfections, unevenness, and colour differences that might be found on the surfaces of finished products, must not be seen as defects but rather as distinctiveness that enhances their beauty and uniqueness.

All images showing finishes and the related colours shown in this price list reproduce the characteristics of the various materials as faithfully as possible, but are purely indicative due to representation and digital printing reasons. Any samples provided for selling are also indicative and may vary according to the product's specific characteristics. The finishes available are only as indicated in our catalogue. Any additional request must be made and, if technically feasible, agreed with our company, before confirming any order.

For proper surface cleaning we recommend using a soft cloth and avoiding the use of any detergent. Avoid exposure to direct sunlight and heat sources.

All the finishes have a code that indicates the internal reference for the article.

In order to avoid any errors when processing an order, we recommend precise use of the model description shown in the price list, indicating the exact article, sizes, quantities, finish code, and any additional requirements. For this reason, the company reserves the right to notify the client of the technical and stylistic feasibility of the chosen product, proposing any solutions that can be adopted as an alternative to what is requested.



<b>Finiture metalliche · Metallic finishes</b>	168
<b>Pietre semipreziose · Semi-precious stones</b>	168
<b>Marmi · Marbles</b>	169
<b>Onici · Onyxes</b>	169
<b>Vetri e specchi · Glass and mirrors</b>	170
<b>Essenze di legno · Wood</b>	171
<b>Pergamena · Parchment</b>	174
<b>Laccati · Lacquered finishes</b>	175
<b>Pelli · Leather</b>	176
<b>Tessuti · Fabrics</b>	184

FINITURE METALLICHE | METALLIC FINISHES

La finitura metallica si riferisce alla colorazione e alla sfumatura cromatica che può essere effettuata su una base di ottone o di acciaio inox a seconda delle esigenze prestazionali ed estetiche del prodotto. Le diverse finiture sono ottenute tramite processi come lucidatura, galvanica, verniciatura e spazzolatura.

La fusione a terra delle leghe di ottone e bronzo si realizza creando nelle staffe la "forma negativa" utilizzando le sabbie naturali con metodo antico. Nella forma lasciata libera viene fusa la lega. Il metallo si solidifica e una volta raffreddato lo si libera dalla sabbia, ed è pronto per le varie fasi di rifinitura. Le superfici pulite e lucidate possono presentare delle imperfezioni, dovute alla caratteristica del materiale, che ne valorizzano la lavorazione artigianale.

The term metallic finish refers to the colouring and chromatic hues that can be achieved on a brass or stainless steel base, to suit the performance and aesthetic requirements of the product. The various finishes are obtained by using processes such as polishing, galvanising, painting, and brushing.

The sandcasting of brass and bronze alloys is obtained by creating the "negative form" in the moulds, using an ancient natural sand method. The alloy is moulded in the form that is left free. The metal solidifies and, once cool, it is taken out of the mould and is ready for the finishing phases. The cleaned, polished surfaces can show imperfections, due to the characteristics of the material, which enhance this artisanal production method.



**ME01**  
bronzato  
bronzed



**ME02**  
bagno oro lucido  
shiny gold plated



**ME03**  
satinato  
satin finish

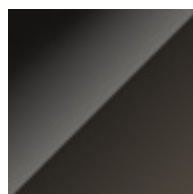

**ME04**  
cromo nero lucido  
black chrome  
glossy

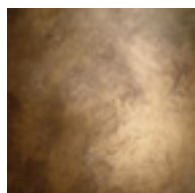

**FU01**  
fusione di bronzo  
bronze casting

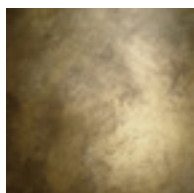

**FU02**  
fusione di ottone  
brass casting

PIETRE SEMIPREZIOSE | SEMI-PRECIOUS STONES

La pietra estratta dai giacimenti si presenta sotto forma di pietra grezza di dimensioni ridotte, tuttavia le realizzazioni possono essere di dimensioni variabili in quanto frutto di una composizione a mosaico. La colorazione e l'iridescenza delle pietre può variare in base alla materia prima. La capacità di ottenere un prodotto finito omogeneo e di colorazione armoniosa è un pregio della lavorazione artigianale.

When the stone is extracted from the quarry, it comes in the form of a rough stone of small dimensions, however, items can be made in various sizes, as they are the result of a mosaic composition. The colour and iridescence of the stones varies basing on the raw material. The skill of obtaining a finished product that is even and harmoniously coloured is the beauty of an artisanal production process.

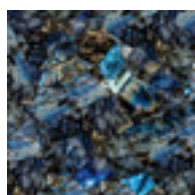

**PS01**  
Labradorite

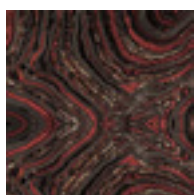

**PS02**  
Ferro Tigrato  
Tiger Iron

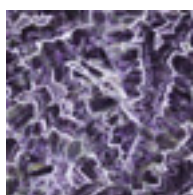

**PS03**  
Ametista  
Amethyst

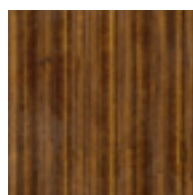

**PS04**  
Occhio di Tigre  
Tiger's Eye

## MARMI | MARBLES

Il marmo è una roccia calcarea con una durezza media, formata da una composizione di cristalli a grana fine che contribuisce a una finitura lucida, mentre l'onice è un materiale calcareo con una grana finissima che risulta essere traslucido. Le venature e la delicatezza delle colorazioni di questi materiali possono variare in base alla materia prima, selezionata tra i migliori blocchi direttamente in cava.

In alcuni casi è possibile diminuire il peso delle lastre accoppiandole a un materiale di supporto tenace e leggero come l'honeycomb, una struttura a nido d'ape di alluminio rivestita in fibra di vetro e resina, oppure diminuirne lo spessore accoppiandole ad altri materiali di supporto come l'alluminio.

Marble is a limestone rock of medium hardness with a fine-grained crystalline composition, which contributes to a shiny finish while Onyx is a limestone rock with a very fine grain that makes it translucent. The veining and the delicate colouring may vary according to the raw material, selected among the best blocks directly in the quarry.

In some cases the weight of slabs can be reduced by coupling them to a strong, light-weight support material like honeycomb - an aluminium honeycomb structure coated in glass fibre and resin - or it can be reduced in thickness by coupling it with other support materials, such as aluminium.

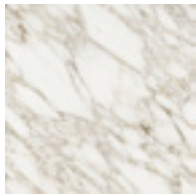

**MA.B01**  
Calacatta Vagli Oro



**MA.B02**  
Bianco Lasa

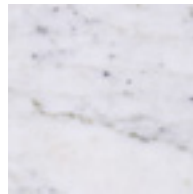

**MA.B03**  
Michelangelo

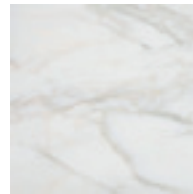

**MA.B04**  
Calacatta Caldia

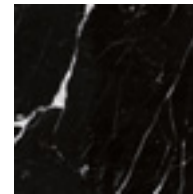

**MA.N01**  
Nero Marquina

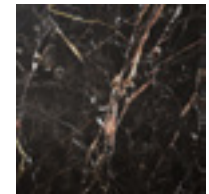

**MA.N02**  
Noir Saint Laurent

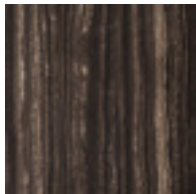

**MA.T01**  
Eramosa

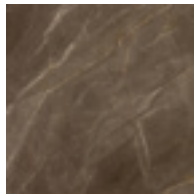

**MA.T02**  
Bronze Amani



**MA.T03**  
Rainforest Green

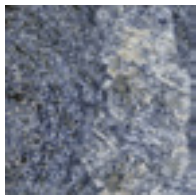

**MA.C01**  
Azul Bahia

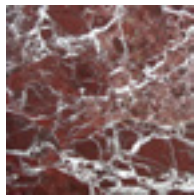

**MA.C02**  
Rosso Lepanto

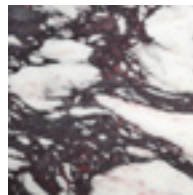

**MA.C03**  
Calacatta Viola

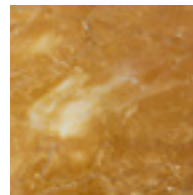

**MA.C04**  
Giallo Siena

## ONICI | ONYXES

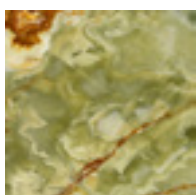

**OX01**  
Onice Verde  
Pakistano  
Pakistan Green Onyx



**OX02**  
Onice Miele  
Honey Onyx



**OX03**  
Onice Rosa Extra  
Pink Extra Onyx

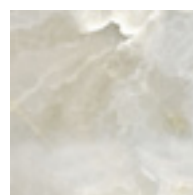

**OX04**  
Onice Bianco Extra  
White Extra Onyx

VETRI | GLASS

La collezione comprende una gamma di vetri e specchi essenziali insieme a una selezione di specchi decorati ed antichizzati di diverse colorazioni. Le lastre antichizzate possono presentare leggere ossidazioni, opacità e sfumature di colore diverse che ne enfatizzano l'effetto tipico degli specchi antichi e non costituiscono difetti ma peculiarità.

Our collection includes an essential selection of glass and mirrors, as well as a selection of decorated and antiqued mirrors in various colours. Antiqued mirror panels can show slight oxidation, opaqueness, and colour hues that differ, emphasising the typical appearance of antique mirrors, which are not to be considered defects but make the product unique.

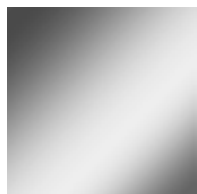

**VE01**  
vetro extrachiaro  
extra-clear glass

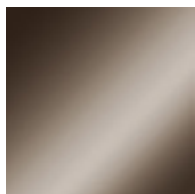

**VE02**  
vetro bronzato  
bronzed glass

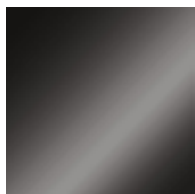

**VE03**  
vetro fumé  
smoked glass



**VD01**  
vetro con  
decorazione a rombi  
glass with diamond  
decoration

SPECCHI | MIRRORS



**SP01**  
specchio naturale  
natural mirror

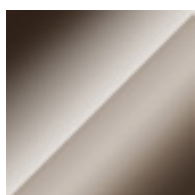

**SP02**  
specchio bronzato  
bronzed mirror

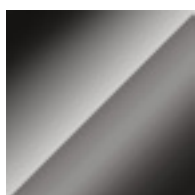

**SP03**  
specchio fumé  
smoked mirror

SPECCHI ANTICHIZZATI | ANTIQUED MIRRORS



**AQ01**  
cobalto  
cobalt



**AQ02**  
arcobaleno  
rainbow



**AQ03**  
cometa  
comet

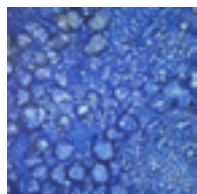

**DM01**  
zaffiro  
sapphire

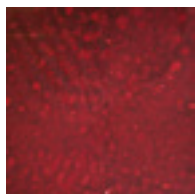

**DM02**  
rubino  
ruby

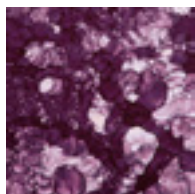

**DM03**  
ametista  
amethyst

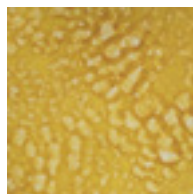

**DM03**  
topazio  
topaz

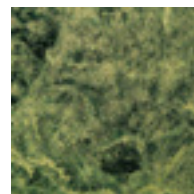

**DM03**  
bosco  
forest

## ESSENZE DI LEGNO | WOODS

Il legno è un materiale naturale ed unico. L'essenza di legno ricavata può presentare variazioni di colore e di venatura determinate da vari fattori come caratteristica della pianta o esposizione del prodotto alla luce del sole anche nella stessa varietà di specie. L'eventuale differenza tra i prodotti non è da considerarsi imperfezione, ma caratteristica di qualità della materia prima.

Le impiallacciate in essenza di legno si realizzano utilizzando fogli di legno nobile di spessore variabile ricavati direttamente dai tronchi di migliore qualità. Questi vengono poi incollati su vari supporti e finiti nella tonalità di tinta desiderata.

Il legno massello è ottenuto direttamente dal tronco dell'albero mediante lavorazioni meccaniche. Le particolarità estetiche e di venatura sono caratteristiche dell'essenza legnosa utilizzata. Il legno massello viene tinto nelle tonalità tipiche delle varie essenze con una lavorazione di verniciatura.

La superficie del prodotto finito viene successivamente protetta con finiture lucide brillanti o opache.

Wood is a unique, natural material. The obtained wood may vary in colour and veining, as a result of various factors such as the plant characteristics or exposure of the product to sunlight, even within the same variety of species. Any difference between products is not to be considered as a flaw but as a sign of quality of the raw material.

Wood veneering is obtained by using sheets of prime wood of various thickness, obtained directly from logs of the finest quality. These sheets are then bonded to various supports and finished in the required colour tone.

The solid wood is taken directly from the tree trunk using mechanical production methods. The unique aesthetics and veining are characteristic of the type of wood used. The solid wood is coloured in typical colours for the various woods by varnishing.

The surface of the finished product is eventually protected by applying glossy or matt finishing.

ERABLE LUCIDO  
GLOSSY MAPLE

**ER01**  
blu cobalto  
cobalt blue

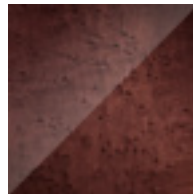

**ER02**  
rosso marsala  
marsala red

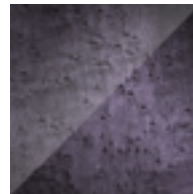

**ER03**  
ametista  
amethyst

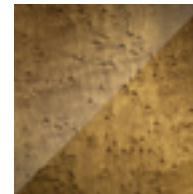

**ER04**  
giallo ocre  
ocher yellow



**ER05**  
nero  
black



**ER06**  
avorio  
ivory

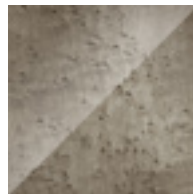

**ER07**  
tortora  
dove grey

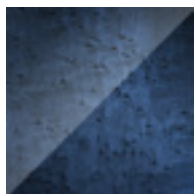

**ERS01**  
blu elettrico  
electric blue

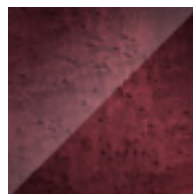

**ERS02**  
rosso rubino  
ruby red

**EUCALIPTO FRISÉ  
LUCIDO  
GLOSSY FRISÉ  
EUCALYPTUS**

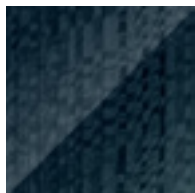

**EF01.G**  
blu cobalto  
cobalt blue

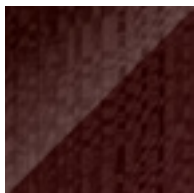

**EF02.G**  
rosso marsala  
marsala red

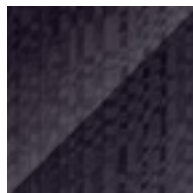

**EF03.G**  
ametista  
amethyst



**EF04.G**  
giallo ocre  
ocher yellow



**EF05.G**  
nero  
black

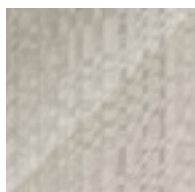

**EF06.G**  
avorio  
ivory

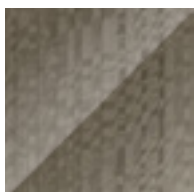

**EF07.G**  
tortora  
dove grey

**EUCALIPTO FRISÉ  
LUCIDO  
CON INTARSIO  
GLOSSY FRISÉ  
EUCALYPTUS  
WITH INLAY**

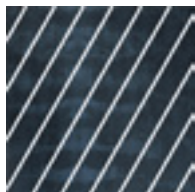

**EFI01.G**  
blu cobalto  
cobalt blue

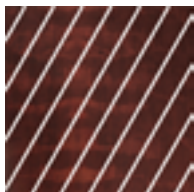

**EFI02.G**  
rosso marsala  
marsala red



**EFI03.G**  
ametista  
amethyst

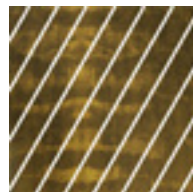

**EFI04.G**  
giallo ocre  
ocher yellow

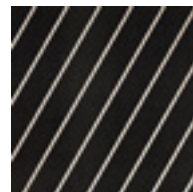

**EFI05.G**  
nero  
black

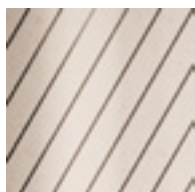

**EFI06.G**  
avorio  
ivory

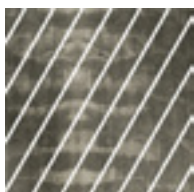

**EFI07.G**  
tortora  
dove grey

**RADICA  
BRIAR**

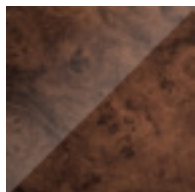

**RA01.G**  
radica di mirto  
naturale  
myrtle briar natural

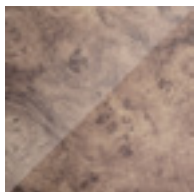

**RA02.G**  
radica di mirto  
avorio  
myrtle briar ivory

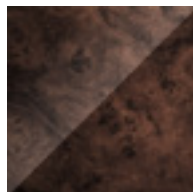

**RA03.G**  
radica amboina  
amboina briar

**CARBALHO  
CARBALHO**

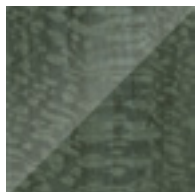

**CB01.G**  
carbalho col. oceano  
lucido  
carbalho ocean  
colour glossy



**CB01.M**  
carbalho col. oceano  
opaco  
carbalho ocean  
colour matt

**ZEBRANO**  
ZEBRAWOOD



**ZB01.G**  
zebrano lucido  
zebrawood glossy



**ZB01.M**  
zebrano opaco  
zebrawood matt

**PALISSANDRO**  
ROSEWOOD



**PL01.G**  
palissandro scuro  
lucido  
dark rosewood  
glossy

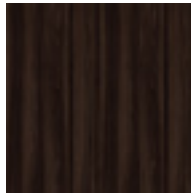

**PL01.M**  
palissandro scuro  
opaco  
dark rosewood matt

**NOCE AMERICANO**  
AMERICAN  
WALNUT



**NA01.G**  
noce americano  
scuro lucido  
dark american  
walnut glossy



**NA01.M**  
noce americano  
scuro opaco  
dark american  
walnut matt

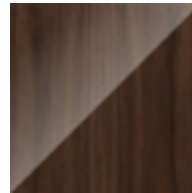

**NA02.G**  
noce americano  
naturale lucido  
natural american  
walnut glossy

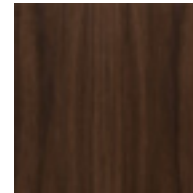

**NA02.M**  
noce americano  
naturale opaco  
natural american  
walnut matt

**FRASSINO**  
ASH WOOD

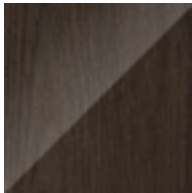

**FS01.G**  
frassino scuro  
lucido  
dark ash wood  
glossy

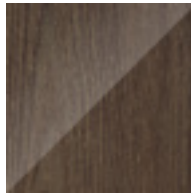

**FS02.G**  
frassino naturale  
lucido  
natural ash wood  
glossy

PERGAMENA | PARCHMENT

Le pelli di pergamena sono accuratamente selezionate ed applicate artigianalmente, ma possono tuttavia presentare variazioni nelle tonalità di colore a causa della loro naturale deformazione e del disomogeneo assorbimento del pigmento anche sulla superficie dello stesso prodotto. Queste caratteristiche indicano la naturalezza del materiale e rendono unica ogni realizzazione.

La superficie del prodotto finito viene successivamente protetta con finiture lucide brillanti o opache.

Parchment sheets are carefully selected and applied artisanally by hand, however, this material may vary in colour tone due to its natural distortion and uneven absorption of the pigment, even on the surface of the same product. These characteristics are a sign of the naturalness of the material, and make each product unique.

The surface of the finished product is eventually protected by applying glossy or matt finishing.



**PE01**  
bianco  
white



**PE02**  
corda  
cord



**PE03**  
avorio  
ivory



**PE04**  
naturale  
natural

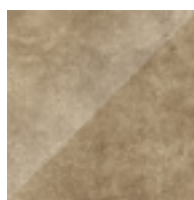

**PE05**  
mandorla  
almond

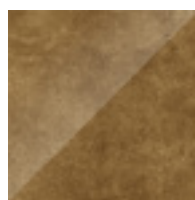

**PE06**  
cuoio  
leather

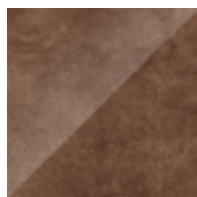

**PE07**  
tabacco  
tobacco

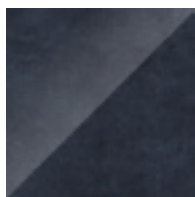

**PE08**  
blu  
blue

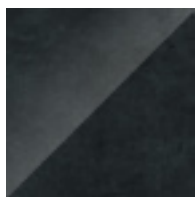

**PE09**  
antracite  
anthracite



**PE10**  
grigio  
grey

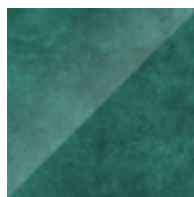

**PE11**  
verde smeraldo  
emerald green

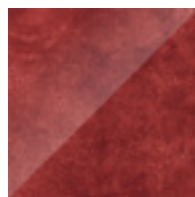

**PE12**  
rosso  
red



**PE13**  
rosa  
pink



**PE14**  
viola  
violet

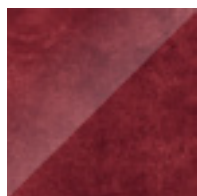

**PES01**  
rosso rubino  
ruby red

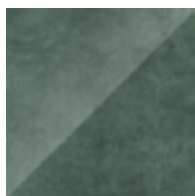

**PES02**  
verde oceano  
ocean green

**Colori speciali**  
Special colours



## LACCATO | LACQUERED

Il laccato è una finitura applicata sul pannello di supporto in legno completamente verniciato nella tonalità di tinta desiderata.

La superficie del prodotto finito viene successivamente protetta con finiture lucide brillanti o opache.

Lacquering is a finish applied to the wooden support panel completely coloured in the required tone. The finished surfaces on the product are protected by applying glossy or matt finishing.

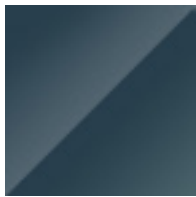

**LA01**  
blu cobalto  
cobalt blue



**LA02**  
rosso marsala  
marsala red

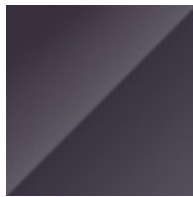

**LA03**  
ametista  
amethyst



**LA04**  
giallo ocre  
ocher yellow



**LA05**  
nero  
black



**LA06**  
avorio  
ivory

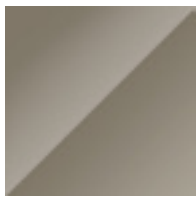

**LA07**  
tortora  
dove grey

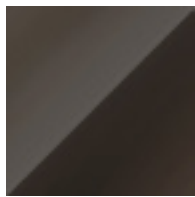

**LA08**  
testa di moro  
dark brown



**LAS01**  
blu elettrico  
electric blue

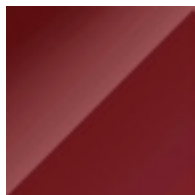

**LAS02**  
rosso rubino  
ruby red

**Colori speciali**  
Special colours

## PELLI | LEATHER

La nostra collezione offre un'ampia gamma di pelli con caratteristiche diverse. La combinazione di questi articoli con le lavorazioni speciali proposte contribuiscono alla realizzazione di un prodotto unico, autentico e di eccellenza.

La vera pelle è un prodotto naturale, pertanto i segni e le imperfezioni che si riscontrano sulla stessa, ad esempio rughe, venature, cicatrici e spinature, oltre a differenze nella tinteggiatura, non sono da considerarsi difetti, bensì elementi distintivi che ne esaltano la bellezza e la contraddistinguono dalla finta pelle e da altri prodotti artificiali.

Per la produzione dei nostri articoli viene effettuata un'accurata selezione dei grezzi, vengono scelte solo le pelli più idonee. Tuttavia può capitare che alcuni segni si evidenzino solo nella fase finale della lavorazione del prodotto.

Un leggero viraggio di colore delle pelli nel tempo è assolutamente naturale. Si consiglia di non esporre i prodotti alla luce diretta del sole.

Our collection offers a wide range of leather with differing characteristics. The combination of these items along with special working processes, contributes to creating a unique, authentic, excellent product.

Genuine leather is a natural product, which means that it might present marks and imperfections, such as wrinkles, veining, scars, and deboning, as well as variations in shades of colour that should not be seen as defect, but as distinctive signs that enhance the beauty and distinguish it from fake leather and other artificial products.

For the creation of our products we carefully select raw leathers, and only the most suitable are chosen. However, it might happen that some marks only show up in the final stage of making the product.

A slight change in colour of the leathers over time is completely natural. We recommend not exposing the products to direct sunlight.

## TIPOLOGIE | TYPES

<b>Nabuk · Nubuck</b>	177
<b>Scamosciato · Suede</b>	177
<b>Pieno fiore · Full grain leather</b>	178
<b>Fiore corretto · Corrected grain leather</b>	179
<b>Struzzo · Ostrich</b>	180
<b>Arapaima · Arapaima</b>	180
<b>Razza · Galuchat</b>	181
<b>Cuoietto da pelletteria · Leatherwear leatherette</b>	182
<b>Cuoietto · Leatherette</b>	183

## NABUK | NUBUCK

Pelle fiore nabuccato tinta in botte all'anilina con grana naturale, una mano vellutata e l'aspetto scamosciato.

Full grained nabuk leather with natural grain coloured in barrels of aniline, with a silky touch and suede appearance.

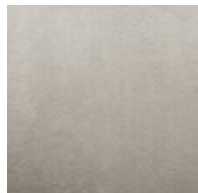

NK2101

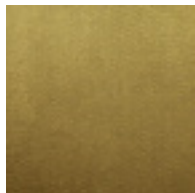

NK2102

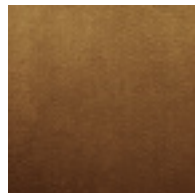

NK2103

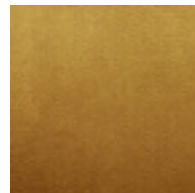

NK2105

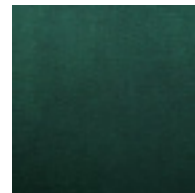

NK2106

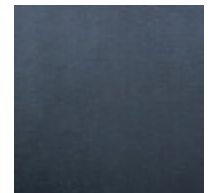

NK2108

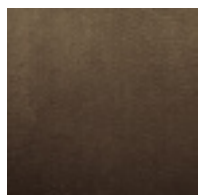

NK2116

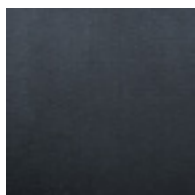

NK2117

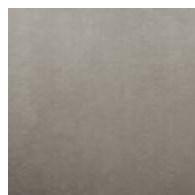

NK2118

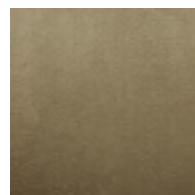

NK2119

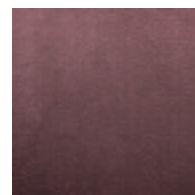

NK2125

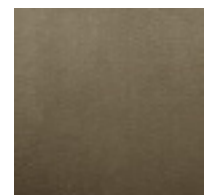

NK2132

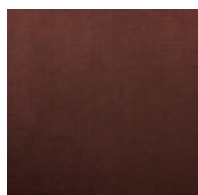

NK2135

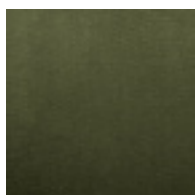

NK2136

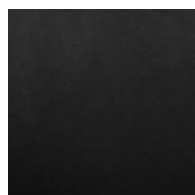

NK2138

## SCAMOSCIATO | SUEDE

Pelle scamosciata dal fiore appena carteggiato, tinta in botte all'anilina, con grana rifinita per dare un effetto bicolore tono su tono. La superficie riporta una lavorazione particolare con un fondo scuro e grana con punte più chiare.

Suede leather with slightly sandpapered grain, coloured in barrels of aniline, with grain finished to provide a two-tone effect. The surface requires particular processing, with a dark background and grain with lighter points.



MT6509

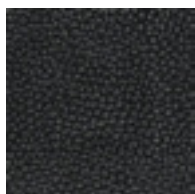

MT6510

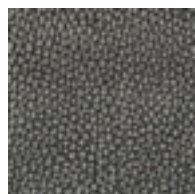

MT6518

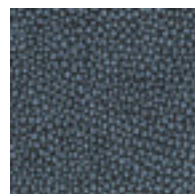

MT6519

PIENO FIORE | FULL GRAIN

Pelle pieno fiore tinta in botte all'anilina dall'aspetto liscio ed elegante.

I prodotti realizzati con pelle all'anilina sono prodotti con pellami pregiati "pieno fiore" la cui peculiarità e l'aspetto naturale della pelle sono percepiti attraverso i suoi segni, venature, ombre diseguali di tonalità e striature.

Full grain leather coloured in barrels of aniline, with a smooth, elegant appearance.

Products made of aniline coloured leather are obtained using prime "full grain" hides, the specific and natural appearance of which are perceived in its marks, veining, and uneven tones and streaking.

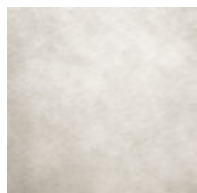

ET5002

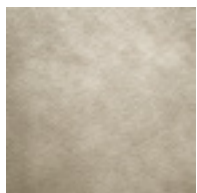

ET5006

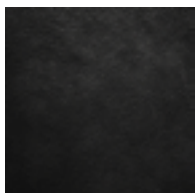

ET5010

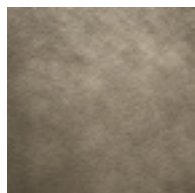

ET5014

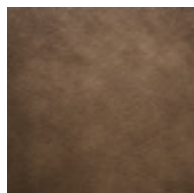

ET5018

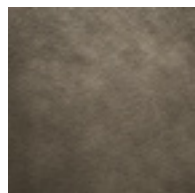

ET5021

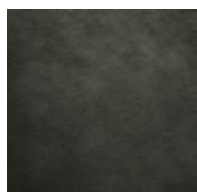

ET5036

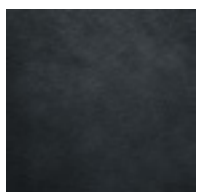

ET5052

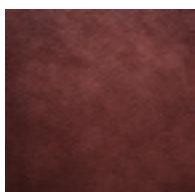

ET5060

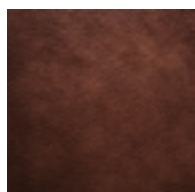

ET5061

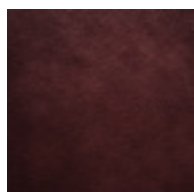

ET5062

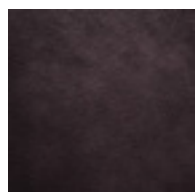

ET5065

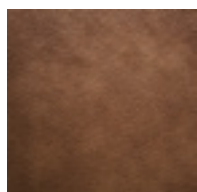

ET5081

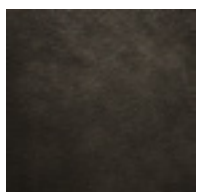

ET5085

**FIORE CORRETTO | CORRECTED GRAIN**

Pelle fiore corretto, tinta in botte all'anilina e polimeri con una superficie liscia e opaca, tatto morbido e setoso.

Corrected grain leather, coloured in barrels of aniline and polymers, with a smooth matt finish, that is soft to the touch and silky.

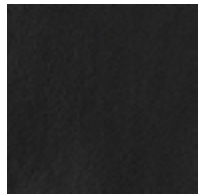

ZF1101

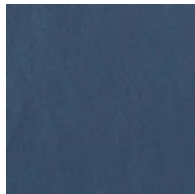

ZF1105

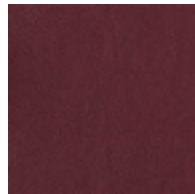

ZF1108

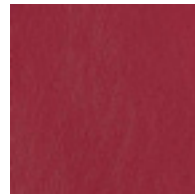

ZF1110



ZF1117

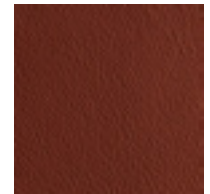

ZF1120

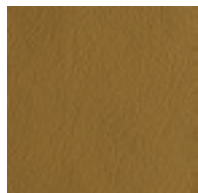

ZF1124



ZF1127

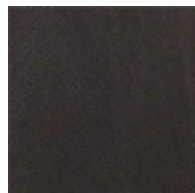

ZF1147

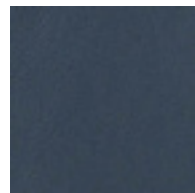

ZF1154

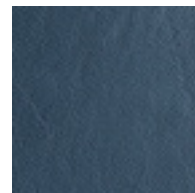

ZF1156

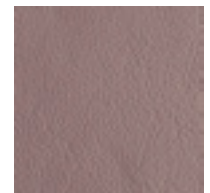

ZF1171

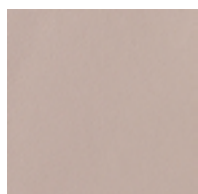

ZF1186

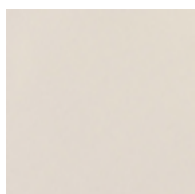

ZF1198

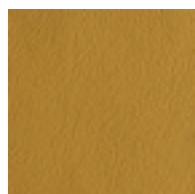

ZF1619

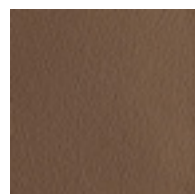

ZF1627

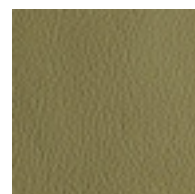

ZF1631

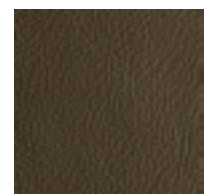

ZF1632

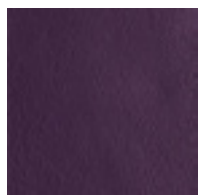

ZF1633

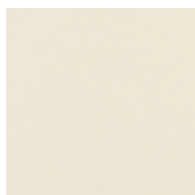

ZF1634

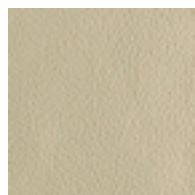

ZF1639



ZF1643

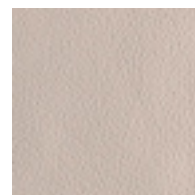

ZF1647

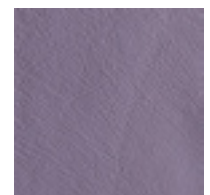

ZF1650

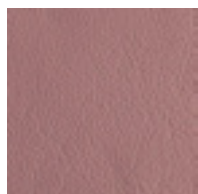

ZF1651

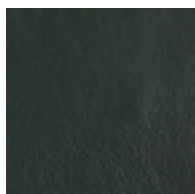

ZF1653

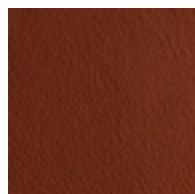

ZF1656

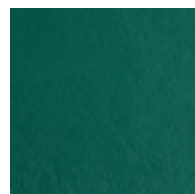

ZF1658



ZF1659

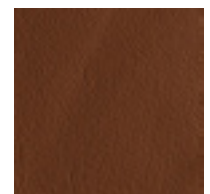

ZF1662

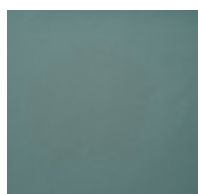

ZF1674

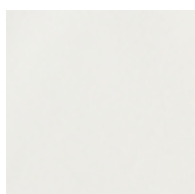

ZF1870

STRUZZO | OSTRICH

Pelle di struzzo vero, tinta in vari colori con una finitura opaca e tatto morbido.

Real ostrich leather, dyed in various colours with a matt finish and soft to the touch.

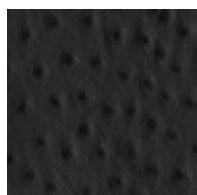

SZ1101

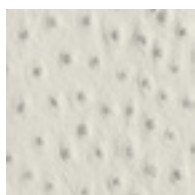

SZ1117

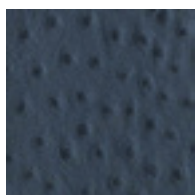

SZ1154



SZ1619

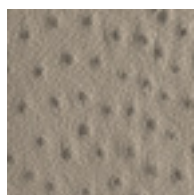

SZ1626



SZ1627



SZ1631



SZ1639

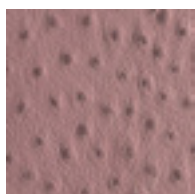

SZ1651



SZ1656

ARAPAIMA | ARAPAIMA

Pelle di arapaima vero (pesce Pirarucu), tinta in vari colori e disponibile in diverse varianti di finitura e opacità. Tatto morbido, aspetto squamoso.

Real arapaima (Pirarucu fish) leather, dyed in various colours and available in various finishes and levels of opaqueness. Soft to the touch, presents scaly appearance.

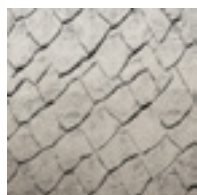

AR2101

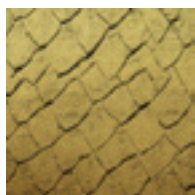

AR2102

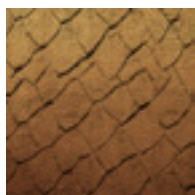

AR2103

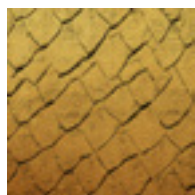

AR2105

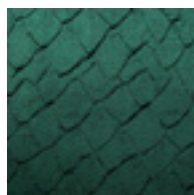

AR2106

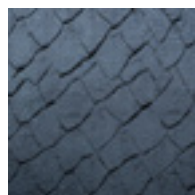

AR2108

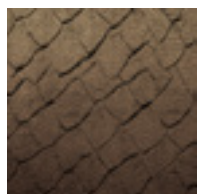

AR2116

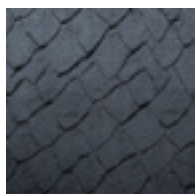

AR2117

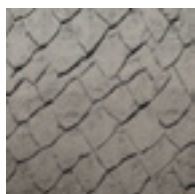

AR2118

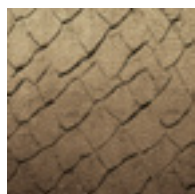

AR2119

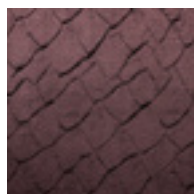

AR2125



AR2132

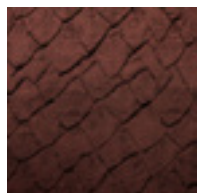

AR2135

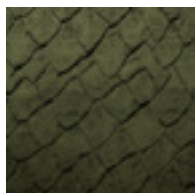

AR2136

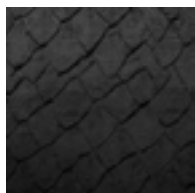

AR2138

## RAZZA | GALUCHAT

Pelle di razza vera, nota anche con il termine Galuchat, tinta in vari colori. Finitura lucida e tatto rigido e corposo. Le dimensioni delle pelli variano intorno a 7", con la forma a diamante o quasi tonda a seconda della specie. Per ragioni tecniche non è possibile garantire la stessa tonalità di colore su tutte le pelli.

Real stingray leather, also known as Galuchat, dyed in various colours. Shiny finish, and stiff, full-bodied feel. The dimensions of the hides vary at around 7", with a diamond or almost round shape, depending on the species. For technical reasons, it is not possible to guarantee the same colour tone on all hides.



**GL01**  
avorio  
ivory



**GL02**  
sabbia  
sand



**GL03**  
oliva  
olive

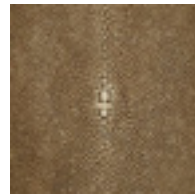

**GL04**  
tabacco  
tobacco



**GL05**  
grigio chiaro  
light grey



**GL06**  
grigio pietra  
stone grey



**GL07**  
caffè  
coffee



**GL08**  
testa di moro  
brown



**GL09**  
bosco  
forest

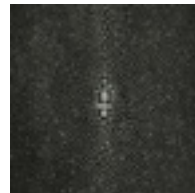

**GL10**  
grigio  
grey

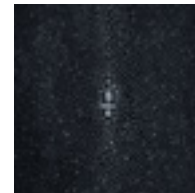

**GL11**  
blu notte  
dark blue

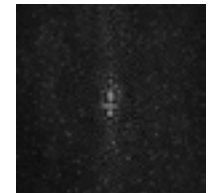

**GL12**  
nero  
black



**GL13**  
verde celadon  
celadon green

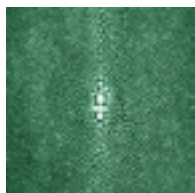

**GL14**  
verde smeraldo  
emerald green

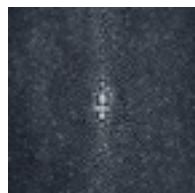

**GL15**  
jeans  
jeans



**GL16**  
blu  
royal blue

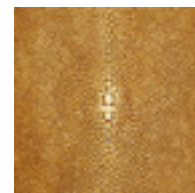

**GL17**  
giallo  
ivoryyellow

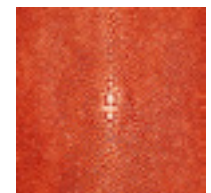

**GL18**  
arancione  
orange

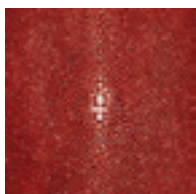

**GL19**  
rosso  
red



**GL20**  
loupiac  
loupiac

CUOINETTO DA PELLETERIA | LEATHERWEAR LEATHERETTE

Il cuoietto da pelletteria è un materiale con una mano morbida ricavato da strati di pellame molto sottili, sottoposto prima alla concia e successivamente a finitura coprente. Il cuoio conciato al vegetale proviene dalle migliori concerie toscane. Gli intrecci in cuoietto da pelletteria sono realizzati interamente su telai e sono disponibili nei seguenti colori.

Leatherwear leatherette is a material with a soft coat, made up of very thin layers of hide, first trimmed and then given a covering finish. Vegetable tanned leather comes from the finest Tuscan producers.

Plaiting of leatherette for leather goods is done entirely on looms, and the product comes in the following colours.

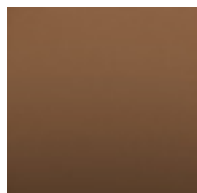

MDC01

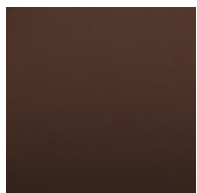

MDC02

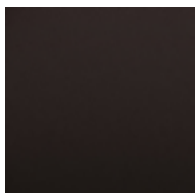

MDC03

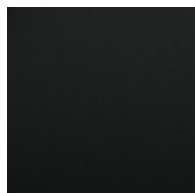

MDC04

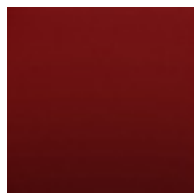

MDC05



MDC06

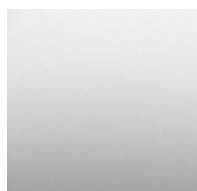

MDC07



MDC08

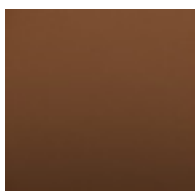

MDC09

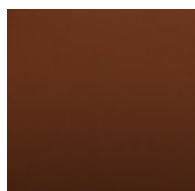

MDC13

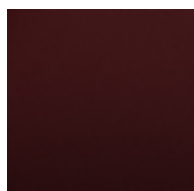

MDC14

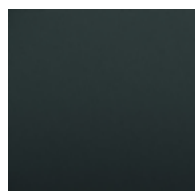

MDC15



MDC32

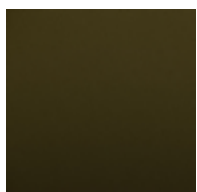

MDC34

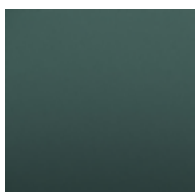

MDC36

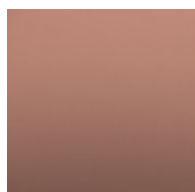

MDC38

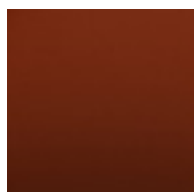

MDC56

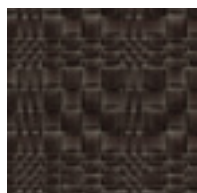

**Esempio di pelle intrecciata**  
Example of plaited leather



CUOINETTO | LEATHERETTE

Cuoietto liscio con superficie omogenea tagliato in spessori maggiori e sottoposto prima alla concia e successivamente a finitura coprente.

Smooth leatherette with an even surface, cut to greater thicknesses, and first trimmed and then given a covering finish.

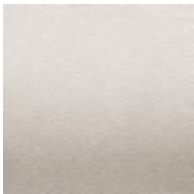

**CU01**  
avorio  
ivory

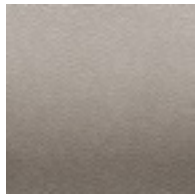

**CU02**  
tortora  
dove grey

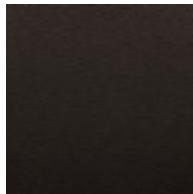

**CU03**  
testa di moro  
brown

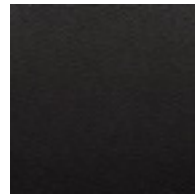

**CU04**  
nero  
black

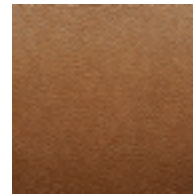

**CU05**  
cuoio  
leather

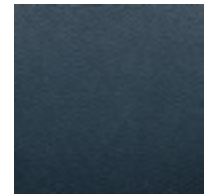

**CU06**  
blu cobalto  
cobalt blue

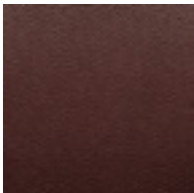

**CU07**  
rosso marsala  
marsala red

## TESSUTI | FABRICS

La nostra collezione offre un'ampia e ricercata gamma di tessuti uniti e decorati presentati di seguito nelle rispettive varianti di colore e perfettamente coordinabili tra di loro.

Accanto ai colori delicati ed estremamente raffinati e colti, una serie di tonalità più calde e intense che creano un dialogo con le pietre semipreziose, i metalli e le essenze esotiche di legno. La combinazione di questi tessuti con le finiture e le lavorazioni speciali contribuiscono alla realizzazione di prodotti unici, autentici e di eccellenza.

Ogni partita di tessuto può presentare variazioni di tonalità rispetto sia al campionario sia ad elementi prodotti in tempi diversi. Inoltre, un leggero viraggio di colore nel tempo è assolutamente naturale. Si consiglia di non esporre i prodotti alla luce diretta del sole.

Tutte le immagini di tessuti riproducono il più fedelmente possibile le loro caratteristiche, ma rimangono puramente indicativi per motivi di rappresentazione e di stampa digitale.

Our collection offers a wide sought-after range of combined, decorated fabrics, shown in the respective varieties of colour, which can be perfectly coordinated with one another.

Alongside the delicate, extremely refined and cultured colours, there is a range of warmer, more intense tones that recall the semi-precious stones, metals, and exotic woods. Combining these fabrics with the special finishes and working processes, contributes to creating unique, authentic, excellent products.

Each batch of fabric may vary in tone from the samples, as well as from items made at different times. In addition, a slight change in colour over time is completely natural. We recommend not exposing the products to direct sunlight.

All the images that show the fabrics represent their characteristics as faithfully as possible, but are purely indicative for representational and digital printing reasons.

## TIPOLOGIE | TYPES

<b>Velluto di seta · Silk velvet</b>	185
<b>Velluto di cotone · Cotton velvet</b>	186
<b>Velluto decorato · Decorated velvet</b>	188
<b>Tessuti decorativi · Decorative fabrics</b>	190

## VELLUTO DI SETA | SILK VELVET

Velluto unito in pura seta presentato in diverse varianti di colore. La seta dona al velluto un'imparagonabile effetto di lucentezza e raffinati riflessi cangianti.

Velvet bound in pure silk, in a range of colour variations. Silk gives velvet an incomparable glossiness and refined changing reflections.



RUVZ001

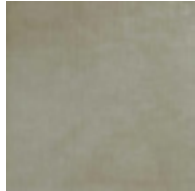

RUVZ003



RUVZ008

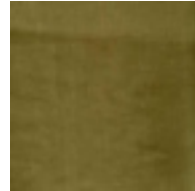

RUVZ011

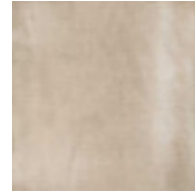

RUVZ012

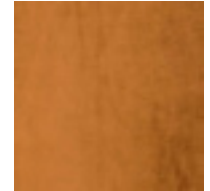

RUVZ013

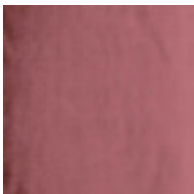

RUVZ014

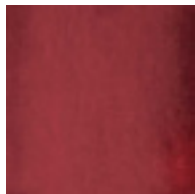

RUVZ016



RUVZ018

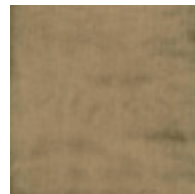

RUVZ019

VELLUTO DI COTONE | COTTON VELVET

Velluto di cotone presentato in un'ampia gamma di colori e tre diverse soluzioni di manifattura e spessore. La selezione non solo si contraddistingue per una mano densa e morbida, ma anche per un velour perfettamente uniforme. I tessuti sono sottoposti a un trattamento speciale in fase di finissaggio, tuttavia, per le caratteristiche proprie del velluto, possono presentare gli effetti naturali di ammaccamento.

Cotton velvet provided in a wide range of colours, and three different manufacturing and thickness solutions. Our selection stands out not only for its dense, soft feel, but also for the perfectly uniform velour. The fabrics undergo a special treatment in the final finishing phase, however, due to the characteristics of velvet, it might show natural hues.

**Velluto a pelo basso**  
Short pile velvet



VELLUTO DI COTONE | COTTON VELVET

Velluto a pelo medio  
Medium pile velvet

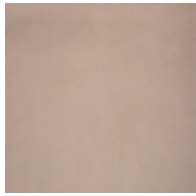

LPAL002

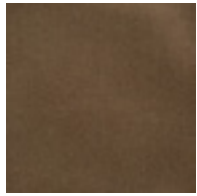

LPAL003

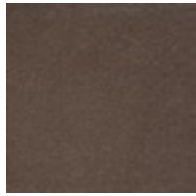

LPAL004



LPAL005



LPAL006



LPAL009

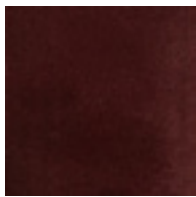

LPAL011

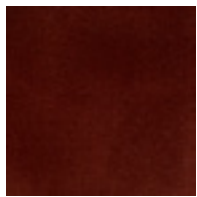

LPAL012

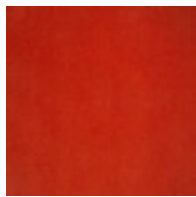

LPAL013

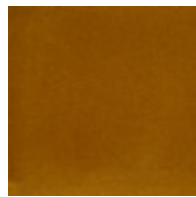

LPAL014

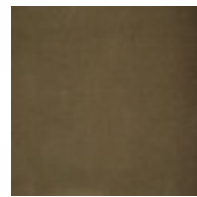

LPAL018



LPAL019

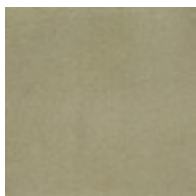

LPAL021

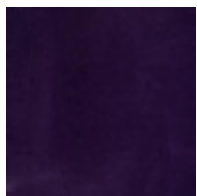

LPAL025

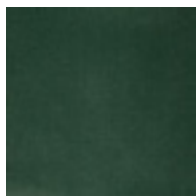

LPAL032

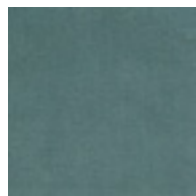

LPAL035

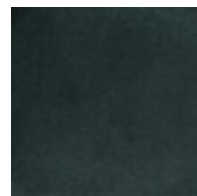

LPAL036

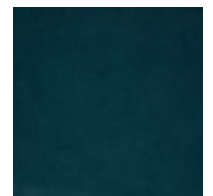

LPAL037

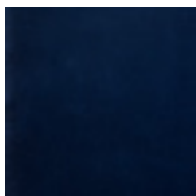

LPAL041

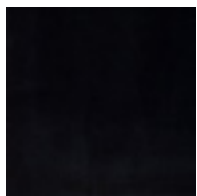

LPAL042



LPAL043



LPAL045

Velluto a pelo alto  
Long pile velvet

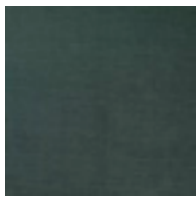

DCVN006

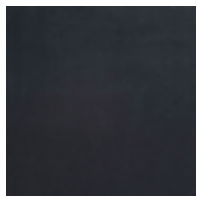

DCVN007

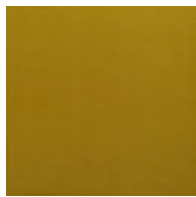

DCVN008

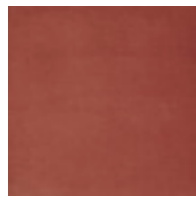

DCVN009

VELLUTO DECORATO | DECORATED VELVET

La collezione comprende una selezione di velluti decorati, perfettamente coordinabili con i tessuti uniti. I velluti sono presentati nelle rispettive varianti di colore con diversi tipi di decorazione come sfumature, stampe, ricami ed epinglès.

Our collection includes a range of decorated velvets that can be perfectly coordinated with other fabrics. The velvets come in the respective colour ranges, with various types of decoration, such as nuances, printed motifs, embroidery, and epingle.

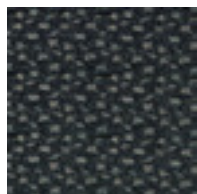

BRVE002

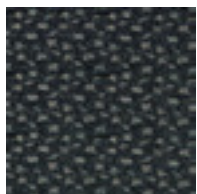

BRVE003

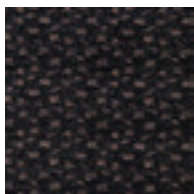

BRVE004

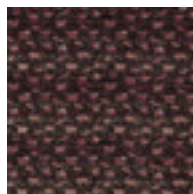

BRVE005

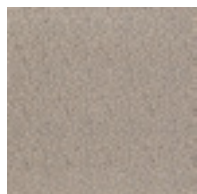

RUSM001

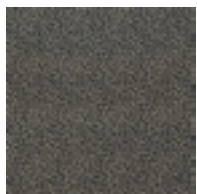

RUSM002

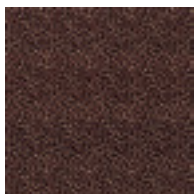

RUSM003

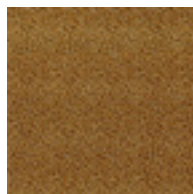

RUSM004

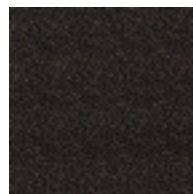

RUSM005

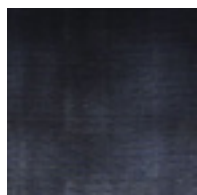

MSAN105

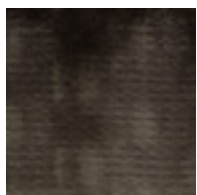

MSAN206

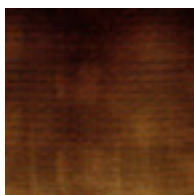

MSAN601

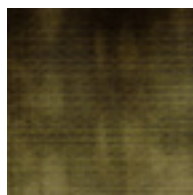

MSAN702

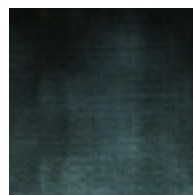

MSAN803

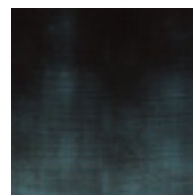

MSAN904

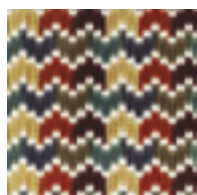

MSET701

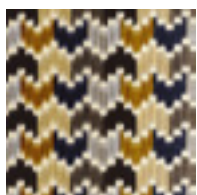

MSET802

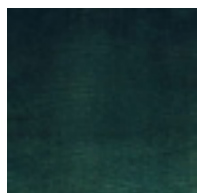

MSPE104

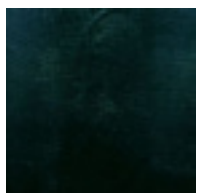

MSPE205

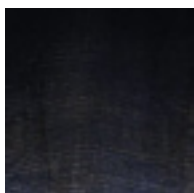

MSPE306

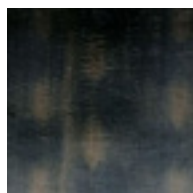

MSPE407

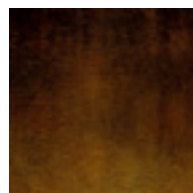

MSPE701

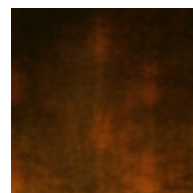

MSPE802

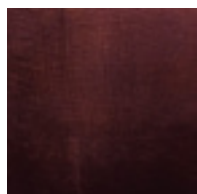

MSPE903

VELLUTO DECORATO | DECORATED VELVET



JBBL011

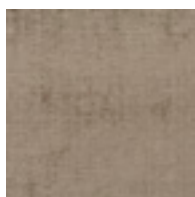

JBBL021

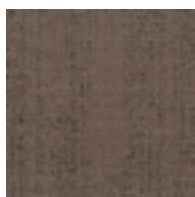

JBBL022

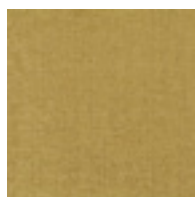

JBBL030

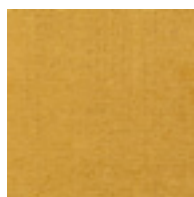

JBBL040

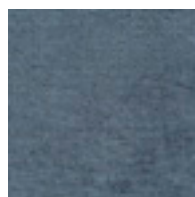

JBBL051

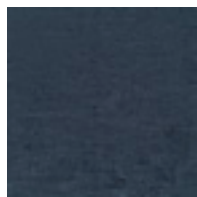

JBBL052



JBBL053

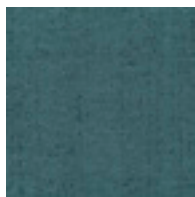

JBBL054

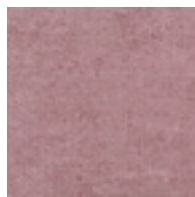

JBBL060

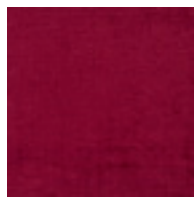

JBBL062

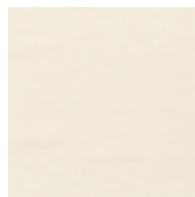

JBBL071

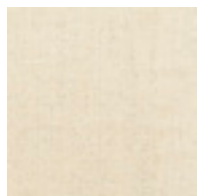

JBBL072



JBBL073



JBBL074

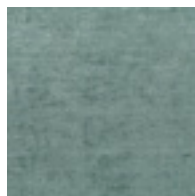

JBBL080

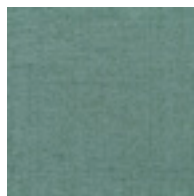

JBBL081

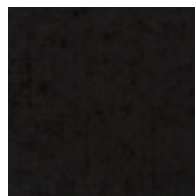

JBBL099

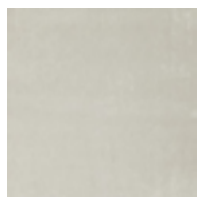

ZNSH001

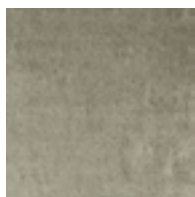

ZNSH002

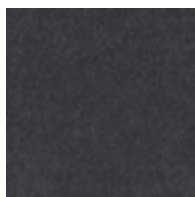

ZNSH012

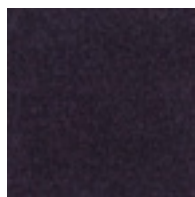

ZNSH013



ZNSH014

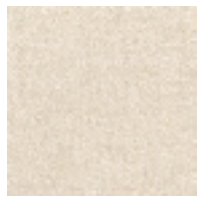

ELNB801

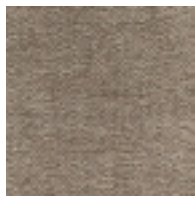

ELNB815



ELNB840

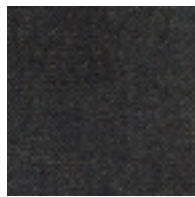

ELNB880



ELNB886

TESSUTI DECORATIVI | DECORATIVE FABRICS

Una pregiata selezione di tessuti decorativi, raffinati tessuti jacquard ed eleganti e giocosi lampassi. La scelta cromatica cita le sfumature delle pietre semipreziose, dei metalli e delle essenze esotiche di legno, creando un dialogo di continuità.

A prime selection of decorative fabrics, refined jacquard fabrics, and elegant, playful lampas. The colour choice recalls the hues of semi-precious stones, metals, and exotic woods, thereby creating continuity throughout the collection..

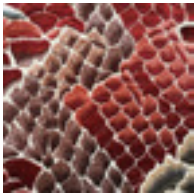

BQBR001

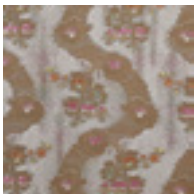

DEDM001



DEDM002

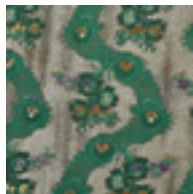

DEDM003

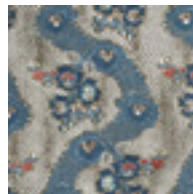

DEDM004



DEDM005

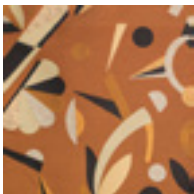

DEMF001

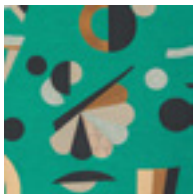

DEMF002

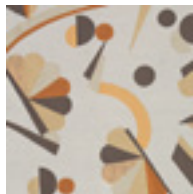

DEMF003



DESG002

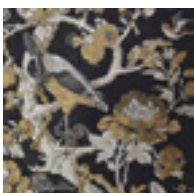

DESJ001

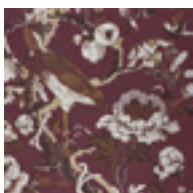

DESJ002

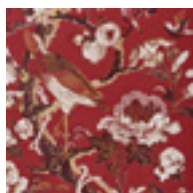

DESJ003

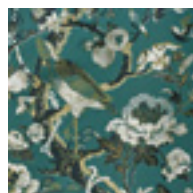

DESJ004

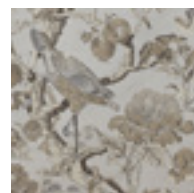

DESJ005



DESJ006



LEGR01

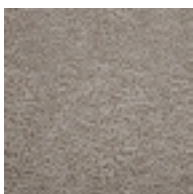

LEGR02

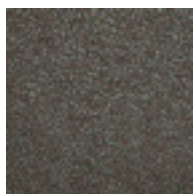

LEGR03

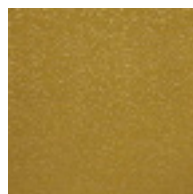

LEGR04

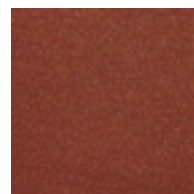

LEGR05



TESSUTI DECORATIVI | DECORATIVE FABRICS



NBKJ003



NBKJ023



NBKJ067



NBSN002



NBSN005



NBSN010

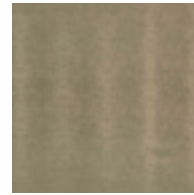

NBSN015



NBSN023



NBSN055

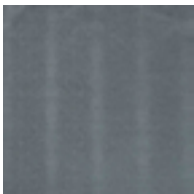

NBSN066

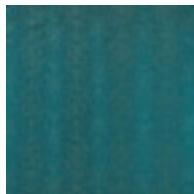

NBSN079

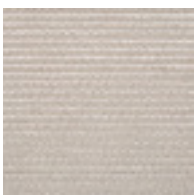

LPLL002



LPLL003



LPLL004

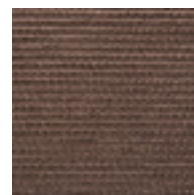

LPLL005



LPLL006

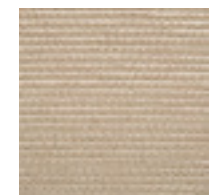

LPLL007



LPLL008

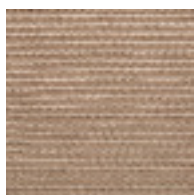

LPLL009

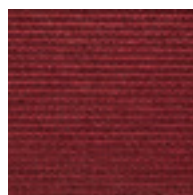

LPLL010

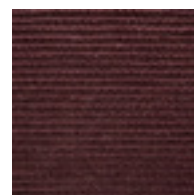

LPLL013



LPLL014



LPLL016

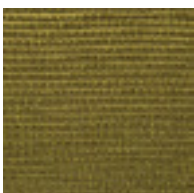

LPLL017

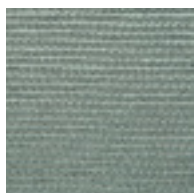

LPLL018

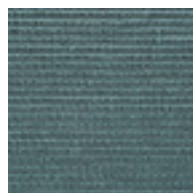

LPLL019

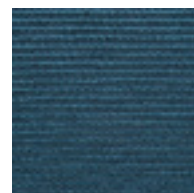

LPLL020

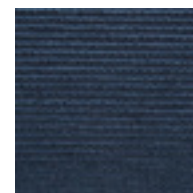

LPLL021

TESSUTI DECORATIVI | DECORATIVE FABRICS

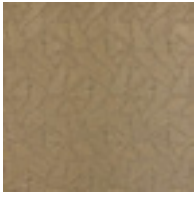

PFAF001



PFGL001



PFGL002



PFGL003



PFGL004

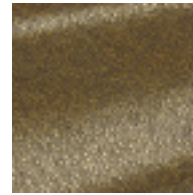

PFGL005



PFGL006

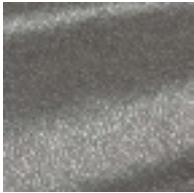

PFGL007

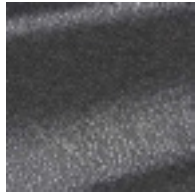

PFGL008

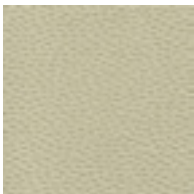

RUCS001

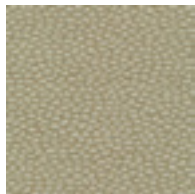

RUCS002

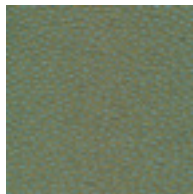

RUCS003



RUCS004

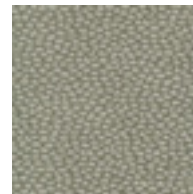

RUCS005

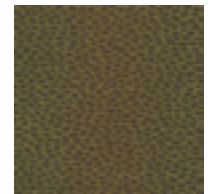

RUCS006

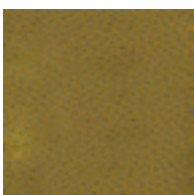

RUCS007

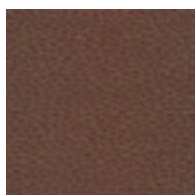

RUCS008

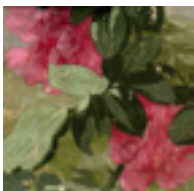

RULR001

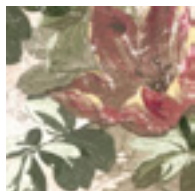

RULR002

TESSUTI DECORATIVI | DECORATIVE FABRICS



RUPV001



RUPV002



RUPV003



RUPV004



ELNB901

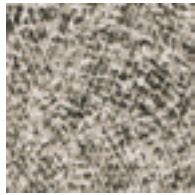

ELNB902



ELNB941



ELNB980

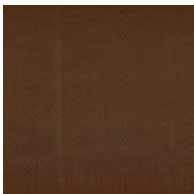

MSPT201

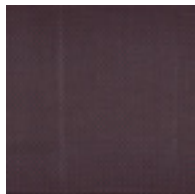

MSPT302



MSPT403

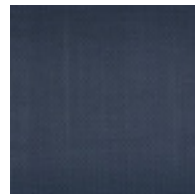

MSPT504



SHCS01



SHCS02

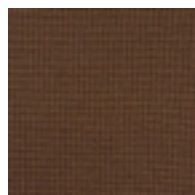

SHCS03

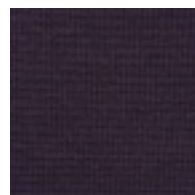

SHCS04

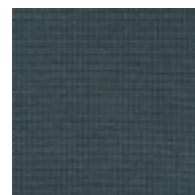

SHCS05

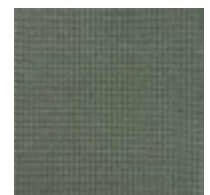

SHCS06

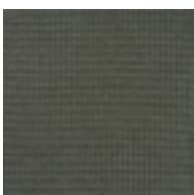

SHCS07

TESSUTI DECORATIVI | DECORATIVE FABRICS

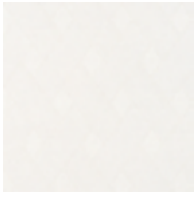

SHSX01

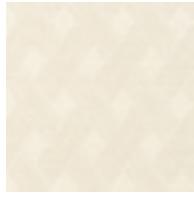

SHSX02

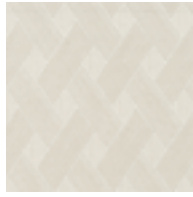

SHSX03



SHSX04

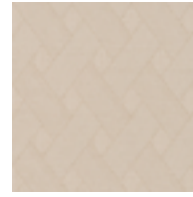

SHSX05



SHSX06

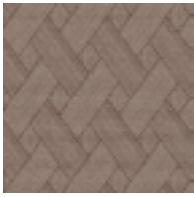

SHSX07



SHSX08



SHSX09



SHSX10

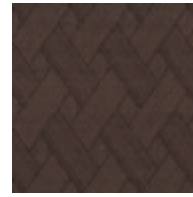

SHSX11

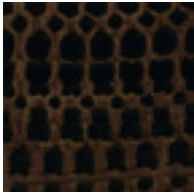

KHMR001

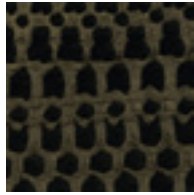

KHMR002

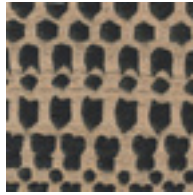

KHMR003

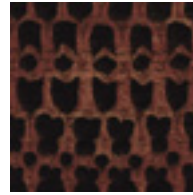

KHMR004

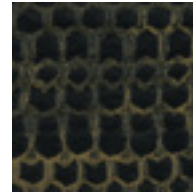

KHMR005

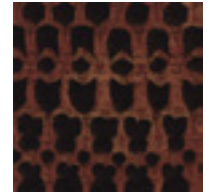

KHMR006



ZFHS900



I LILLA	<b>Tavolino basso</b> · Coffee table	143
	<b>Tavolino medio</b> · Medium table	144
	<b>Tavolino alto</b> · Small table	145
I NOCCIOLI	<b>Tavolino basso</b> · Coffee table	146
	<b>Tavolino piccolo</b> · Small table	147
I RODODENDRI	<b>Tavolino basso</b> · Coffee table	136
	<b>Tavolino alto</b> · Small table	138
	<b>Consolle</b> · Console	140
	<b>Tavolino laterale</b> · Side table	142
IL BOSSO	<b>Specchio</b> · Mirror	133
IL CARPINO	<b>Libreria</b> variante 1 · <b>Bookcase</b> variant 1	160
	<b>Libreria</b> variante 2 · <b>Bookcase</b> variant 2	162
IL CASTAGNO	<b>Divano</b> · Sofa	78
	<b>Poltrona</b> · Armchair	80
IL CEDRO	<b>Scrivania</b> variante 1 · <b>Desk</b> variant 1	156
	<b>Scrivania</b> variante 2 · <b>Desk</b> variant 2	158
IL CILIEGIO	<b>Letto</b> variante 1 · <b>Bed</b> variant 1	8
	<b>Letto</b> variante 2 · <b>Bed</b> variant 2	10
IL CIPRESSO	<b>Tavolo rettangolare</b> · Rectangular table	49
IL CIRMOLO	<b>Letto</b> · Bed	28
IL CORBEZZOLO	<b>Poltroncina</b> · Small armchair	54
IL FRASSINO	<b>Divano</b> · Sofa	84
	<b>Poltrona</b> · Armchair	86
IL GELSO	<b>Tavolo rotondo</b> · Round table	42
IL GINEPRO	<b>Mobile bar</b> · Bar cabinet	108
IL LAURO	<b>Paravento</b> · Screen	130
IL LECCIO	<b>Scrittoio</b> · Writing desk	154
IL MELOGRANO	<b>Paravento</b> modulo A · <b>Screen</b> module A	126
	<b>Paravento</b> modulo B · <b>Screen</b> module B	128
IL MIRTO	<b>Mobile bar</b> variante 1 · <b>Bar cabinet</b> variant 1	104
	<b>Mobile bar</b> variante 2 · <b>Bar cabinet</b> variant 2	106
IL NOCE	<b>Libreria</b> singola variante 1 · Single <b>bookcase</b> variant 1	110
	<b>Libreria</b> singola variante 2 · Single <b>bookcase</b> variant 2	112
	<b>Libreria</b> doppia variante 1 · Double <b>bookcase</b> variant 1	114
	<b>Libreria</b> doppia variante 2 · Double <b>bookcase</b> variant 2	116
	<b>Libreria</b> doppia con ante variante 1 · Double <b>bookcase</b> with doors variant 1	118
	<b>Libreria</b> doppia con ante variante 2 · Double <b>bookcase</b> with doors variant 2	120
	<b>Moduli libreria</b> · <b>Bookcase modules</b>	122
IL PLATANO	<b>Tavolo ovale</b> variante 1 · <b>Oval table</b> variant 1	45
	<b>Tavolo ovale</b> variante 2 · <b>Oval table</b> variant 2	46
	<b>Tavolo ovale</b> variante 3 · <b>Oval table</b> variant 3	47
	<b>Tavolo ovale</b> variante 4 · <b>Oval table</b> variant 4	48
IL PRUGNOLO	<b>Sedia</b> · Chair	56
	<b>Poltroncina</b> · Small armchair	57

IL SAMBUCO	<b>Tavolino basso · Coffee table</b>	134
IL TIGLIO	<b>Divano · Sofa</b>	88
	<b>Poltrona · Armchair</b>	90
L'ALBICOCCO	<b>Pouf · Pouf</b>	151
L'ALLORO	<b>Specchio · Mirror</b>	132
L'AGRIFOGLIO	<b>Poltroncina lounge variante 1 · Lounge armchair variant 1</b>	94
	<b>Poltroncina lounge variante 2 · Lounge armchair variant 2</b>	96
	<b>Divanetto variante 1 · Loveseat variant 1</b>	98
	<b>Divanetto variante 2 · Loveseat variant 2</b>	100
	<b>Sedia variante 1 · Chair variant 1</b>	50
	<b>Sedia variante 2 · Chair variant 2</b>	51
	<b>Sedia variante 3 · Chair variant 3</b>	52
L'EUCALIPTO	<b>Divano · Sofa</b>	70
	<b>Poltrona · Armchair</b>	72
	<b>Poltrona vis-à-vis con frangia · Armchair vis-à-vis with fringe</b>	74
	<b>Poltrona vis-à-vis · Armchair vis-à-vis</b>	76
L'OLEANDRO	<b>Sedia · Chair</b>	53
GLI OLMI	<b>Tavolino basso quadrato · Coffee table square</b>	148
	<b>Tavolino basso rettangolare · Coffee table rectangular</b>	149
	<b>Tavolino alto · Small table</b>	150
LA BETULLA	<b>Poltrona · Armchair</b>	92
LA CAMELIA	<b>Credenza · Sideboard</b>	66
LA MAGNOLIA	<b>Divano · Sofa</b>	82
LA PALMA	<b>Credenza · Sideboard</b>	64
LA QUERCIA	<b>Credenza variante 1 · Sideboard variant 1</b>	58
	<b>Credenza variante 2 · Sideboard variant 2</b>	60
	<b>Credenza variante 3 · Sideboard variant 3</b>	62
LA ROBINIA	<b>Tavolo rotondo variante 1 · Round table variant 1</b>	43
	<b>Tavolo rotondo variante 2 · Round table variant 2</b>	44
LA ROBINIA D'ORO	<b>Tavolino basso · Coffee table</b>	135
LE GINESTRE	<b>Comò variante 1 · Chest of drawers variant 1</b>	12
	<b>Comò variante 2 · Chest of drawers variant 2</b>	14
	<b>Comodino variante 1 · Bedside table variant 1</b>	16
	<b>Comodino variante 2 · Bedside table variant 2</b>	18
	<b>Toeletta variante 1 · Dressing table variant 1</b>	20
	<b>Toeletta variante 2 · Dressing table variant 2</b>	22
	<b>Pouf grande · Large pouf</b>	24
	<b>Pouf piccolo · Small pouf</b>	26
LE TAMERICI	<b>Comò · Chest of drawers</b>	32
	<b>Comodino · Bedside table</b>	34
	<b>Toeletta · Dressing table</b>	36
	<b>Scrivania · Writing desk</b>	38

### **I prezzi indicati nel listino sono espressi in Euro, IVA esclusa.**

Questo listino prezzi non costituisce offerta e può essere variato in qualsiasi momento e con minimo preavviso.

I dati tecnici, le misure e le immagini dei prodotti e delle finiture sono indicativi.

VITO LUPO Srl si riserva la facoltà di variare in qualunque momento dimensioni e tipo di costruzione dei propri prodotti, nonché apportare migliorie e varianti, a suo insindacabile giudizio, nel rispetto delle caratteristiche sostanziali della fornitura.

L'utilizzo di materiali naturali come il legno può comportare differenze di tonalità. Sono pertanto possibili differenze di colore tra lotti di produzione diversi. Le tonalità di colore dei tessuti e delle pelli possono variare da una partita all'altra. L'esposizione dei prodotti alla luce solare altera i colori originali delle finiture, dei tessuti e delle pelli. Il pellame può presentare sulla superficie delle piccole imperfezioni, come cicatrici e rughe, che sono da considerarsi caratteristica naturale del prodotto.

Modifiche delle caratteristiche, dimensioni e finiture dei prodotti dovranno essere approvate preventivamente dalla VITO LUPO Srl e comporteranno una variazione di prezzo.

Gli ordini sono regolati dalle presenti condizioni generali di vendita, previa approvazione da parte della VITO LUPO Srl. I termini di consegna non hanno valore tassativo, ed eventuali ritardi di spedizione non daranno luogo a pretese di danni o interessi da parte del Cliente.

Le condizioni di resa della merce vengono pattuite con il committente. I prezzi indicati nel listino si intendono franco fabbrica, Nova Milanese.

Non saranno accettate contestazioni sulla fornitura trascorsi 8 (otto) giorni dal ricevimento della merce. Eventuali reclami riguardanti la merce dovranno essere inoltrati alla VITO LUPO Srl mediante lettera raccomandata A.R. entro 8 (otto) giorni dal ricevimento della merce. Eventuali reclami di qualsiasi natura, non danno diritto al committente di sospendere i pagamenti pattuiti.

Il committente non può rendere alla VITO LUPO Srl merci regolarmente acquistate se non previa autorizzazione scritta dalla VITO LUPO Srl. Le merci devono essere restituite con imballo adeguato.

In caso di ritardato pagamento verranno applicati gli interessi di mora al tasso commerciale corrente. Questo darà diritto alla VITO LUPO Srl di sospendere ogni altra fornitura in corso. I pagamenti dovranno essere effettuati direttamente alla VITO LUPO Srl.

Per ogni eventuale controversia è competente il foro di Monza-Brianza.

### **The prices indicated in the price-list are in Euro, VAT excluded.**

This price-list doesn't serve as the offer and it can be changed at any moment and with the minimal prior advice.

The technical data, measures and images of the products and finishes are indicative.

VITO LUPO Srl reserves the possibility to vary the sizes and the way of construction of its products at any time, as well as to make the changes and improvements at its own discretion regarding the substantial characteristics of supply.

The use of natural materials like the wood may involve the difference in tonality. That's why the difference of colour between different lots of production is possible. The tonalities of the colour of fabrics and leathers may vary from one consignment to the other. The exposition of the products at the sun lights changes the original colours of the furniture, fabric and leather. The hide can have the small imperfections on its surface, like scars and wrinkles that are to consider as natural characteristics of the product.

The modifications of the characteristics, dimensions and finishes of the products should be previously approved by VITO LUPO Srl and they will involve the change of the price.

The orders are regulated by the present general conditions of sale after the approval by VITO LUPO Srl. The delivery terms are indicative and eventual delays of shipment don't give the place to the claim of damage or interest from the Client's party.

The delivery conditions of the goods are agreed with the customer. The prices indicated in the price list are ex works, Nova Milanese.

Rejections of supply will not be accepted after 8 (eight) days on receiving the goods. Eventual claims concerning the goods shall be sent to VITO LUPO Srl by means of registered letter before 8 (eight) days from the receipt of the goods. Eventual claims of any nature will not permit to the customers to suspend the agreed payments.

The customer cannot return the goods regularly purchased to VITO LUPO Srl without prior written authorization by VITO LUPO Srl. The goods shall be sent back with the appropriate package.

In case of delayed payment the percent interests of current commercial rate will be applied. This will permit to VITO LUPO Srl to suspend every other supply in process. The payments shall be arranged directly to VITO LUPO Srl.

The Court of Monza-Brianza is competent for any eventual controversy.



Copyright © 2019 by VITOLUPO. Tutti i diritti riservati. Questa pubblicazione o qualsiasi parte della stessa non possono essere riprodotte o usate in alcun modo senza l'esplicito consenso scritto di Vito Lupo Srl.

Copyright © 2019 by VITOLUPO. All rights reserved. This publication or any portion thereof may not be reproduced or used in any manner whatsoever without the express written permission of the publisher.

---

CONTATTACI | CONTACT US

# VITOLUPO

---

ITALIAN ARTDESIGN

**Show-room e Stabilimento produttivo**  
**Showroom and Production site**

Vito Lupo Srl  
Via Privata delle Industrie 2  
20834 Nova Milanese (MB)  
Tel. +39 0362 19006  
[info@vito-lupo.com](mailto:info@vito-lupo.com)  
[www.vito-lupo.com](http://www.vito-lupo.com)





