



LUXURY CRAFTED IN VERONA

THE PRODUCTS

1
VOLUME



ZB
Bruno Zampa
LUXURY CRAFTED IN VERONA

INDEX

VOL. 01

INTRODUCTION 4

SOFAS, ARMCHAIRS & COMPLEMENTS

SOFAS 20
ARMCHAIRS 96
DORMEUSE 146
POUFS 156
SOFA TABLES 164

TABLES & DINING CHAIRS

DINING TABLES 206
DINING CHAIRS 248
BAR COUNTERS AND STOOLS 274

SUMMARY 284

VOL. 02

INTRODUCTION 4

BEDS & COMPLEMENTS

BEDS 20
BEDSIDE TABLES 50
CHEST OF DRAWERS 64
DRESSING TABLES 76
BENCHES 88

CABINETS

CONSOLLES 98
SIDEBOARDS 120
TV UNITS 140
DISPLAY CABINETS 160
BOOKSHELVES 174
CABINETS 184

OFFICE

DESKS 214
OFFICE CHAIRS 222

OCCASIONALS & DECORATIONS

MIRRORS 230
DECORATIONS 244
RUGS 256
LIGHTINGS 266

SUMMARY 280

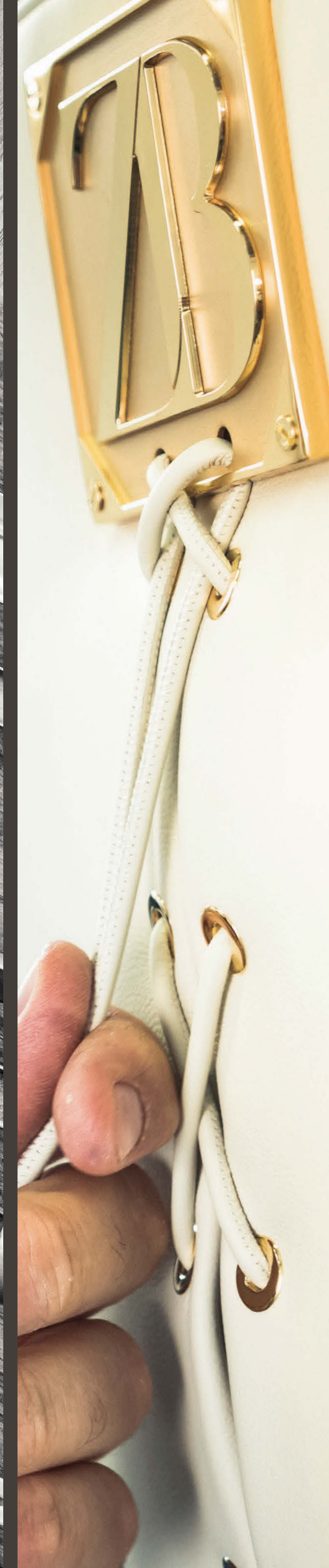

LUXURY CRAFTED IN VERONA

Luxury is crafted. Not made.
Luxury crafted by artisans is the most precious.
Artisans are not all the same.
That's why our craftsmanship is based exclusively in Verona.
To thrive on the heritage of Verona's art and lifestyle.

Il lusso è arte manuale. Non è semplicemente prodotto.
Il lusso realizzato dagli artigiani è il più prezioso.
Gli artigiani non sono tutti uguali.
Per questo la nostra maestria artigianale opera esclusivamente a
Verona. Città custode di un immenso patrimonio artistico e simbolo
di uno stile di vita esclusivo.

Люкс - это ручная работа, а не простой продукт.
Люкс реализован вручную мастерами и более ценен.
Все мастера не похожи друг на друга.
Именно поэтому наши мастера исключительно из Вероны.
Где рождается наследие искусства и образ жизни.

奢侈是匠心创造的艺术。而不仅仅是产品。
匠人所创造的奢侈是最珍贵的。
而匠人并非各个都一样。
我们只用维罗纳的匠人。
因为，这里有独特的生活与艺术底蕴。

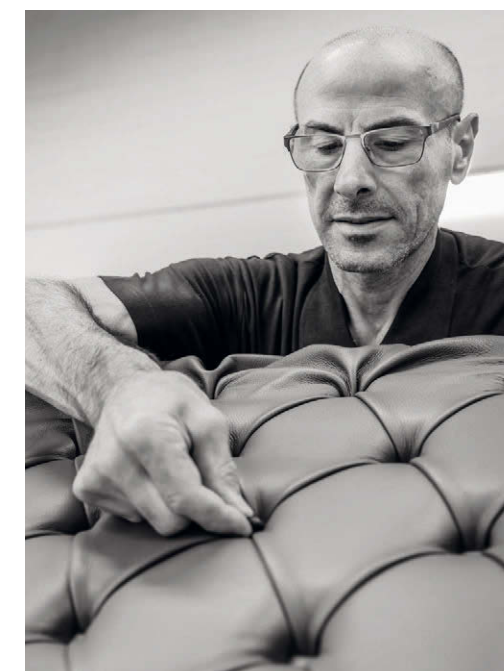



Bruno Zampa

Founder, since 1960.



Ruben, craftsman in Bruno Zampa for 18 years.



Anna, final buffer, is checking all the smallest details in our polishing center.



Andrea, quality manager, is carrying out the last finishing touches.



A RELIABLE PARTNER FOR YOUR BUSINESS



Andrea Zampa,
General Manager,
is welcoming clients
in our Gallery.

Working with custom made luxury, one wishes to avoid problems or solve them efficiently. That's why Bruno Zampa grants:

- Budget safe approach
- Focus on custom made projects
- Company credibility, unchanged ownership since 1960
- Clever solutions for "impossible" requests
- Reliability beyond legal warranty

Nel settore del lusso e delle creazioni di alta gamma personalizzate, sono necessarie soluzioni efficienti.

Per questo Bruno Zampa garantisce:

- Rispetto del budget
- Focus su progetti personalizzati
- Solidità aziendale, sempre la stessa proprietà dal 1960
- Soluzioni efficaci per richieste "impossibili"
- Affidabilità oltre le garanzie legali

При работе с элитной продукцией, создаваемой по специальному заказу, каждый хотел бы избежать проблемных ситуаций и эффективно справиться с возникающими сложностями.

Поэтому Bruno Zampa предлагает:

- рациональный финансовый подход
- фокус на индивидуальном проекте
- надежность — руководство компании не менялось с 1960 г
- находчивые решения к твоим «невозможным» запросам
- ответственность и юридическую гарантию

选择高端定制，意味着全程无忧的高效解决方案。

这也正是 Bruno Zampa 向您做出的承诺：

- 符合您的预算设定
- 满足您的定制要求
- 卓越公司信誉，自 1960 年起从未易主
- 以最佳方案将“不可能”变为可能
- 以高于法律要求的标准，成为您的无忧选择





Matteo De Stefani, architect,
designer of Bruno Zampa collections.

CUSTOM
MADE
FURNITURE
FOR YOUR
DESIGN





Bruno Zampa is focused on custom made solutions:

- Extended product range, with 15.950 combinations in materials and finishing
- 43% of our overall production is customized and not in the standard range
- Our creative and technical staff is at customer's disposal to customize products and projects
- The appointed Project Manager will be the only interface to deal with

Bruno Zampa è focalizzata su soluzioni personalizzate:

- Ampia gamma disponibile, 15.950 combinazioni di materiali e finiture
- Il 43% della nostra produzione è su misura
- Il nostro staff creativo e tecnico è a disposizione per la personalizzazione di prodotti e progetti
- Il Project Manager assegnato sarà l'unico riferimento dall'avvio alla chiusura del progetto

Bruno Zampa — это индивидуальные решения:

- широкий ассортимент товаров, 15.950 сочетаний материалов и отделки мебели
- 43% нашей продукции нет в каталоге, так как она персонализирована
- Наш дизайнерский и технический персонал в твоём распоряжении, для того чтобы персонализировать модели и проекты
- У тебя будет проект-менеджер, который будет исключительно в твоём распоряжении

Bruno Zampa 专注于定制解决方案:

- 超细化产品分类, 15.950 种材料和饰面组合
- 43% 的产品都无法在目录中找到, 因为它们都是个人定制的
- 我们的创意团队和专业团队为你提供定制的产品和设计
- 你将会拥有你专属的项目经理

*Mattia, interior designer,
is creating the project's moodboard*



EXPERIENCE THE CRAFTSMANSHIP: COME TO THE VERONA HUB

Luxury cannot be told.
One has to touch it, smell
it and feel it. It can not be
imagined.

In our Verona HUB
customers will experience:

- Our luxury craftsmanship
at work in our 4 production
units: joinery, tailoring,
upholstery, polishing
- 11 projects in our 1.025 m²
Gallery
- The meeting with our
design team

Il lusso non può essere espresso
con parole.
Per comprenderlo è necessario
toccarlo e assaporarlo. Non può
essere semplicemente immaginato.
Nel nostro HUB i clienti possono
vedere e vivere:

- I nostri artigiani del lusso al
lavoro nelle 4 unità produttive:
 falegnameria, sartoria,
 tappezzeria, lucidatura
- 11 progetti ambientati nella
nostra galleria di 1.025 m²
- l'incontro con il nostro team di
progettazione

Роскошь невозможно выразить
словами.
Ее нужно прочувствовать:
прикоснуться к ней и ощутить
ее вкус. Не пытайтесь
представить ее.
В нашем центре в Вероне вас
ждет:

- наше мастерство изготовления
на деле: столярные работы,
подгонка, обивка и полировка
изделий
- 11 проектов в галерее
площадью 1025 м²
- знакомство с командой
дизайнеров

奢侈不可言之。
您必须触于手，嗅于鼻，感于心。
而非凭空想象。
在我们维罗纳的中心，您将体验到：
- 我们四个制作单位的精湛技艺：
细木工、剪裁、内饰和抛光
- 我们 1.025 平方米的展厅，呈现
11 个特色各异的项目
- 与我们的设计团队亲自会面沟通

AMAZON

SOFA



Struttura in legno massello; basamento in legno. Copri bracciolo in pelle con fibbia in ottone. Cuscini di seduta e schienale in vera piuma con inserto in poliuretano. Meccanismo per divano letto non disponibile.

Solid wood frame; wooden base. Leather armrest saddle-covers, with brass buckle. Seat and back cushions in natural feather with polyurethane insert. Bed mechanism not available.

Каркас из массива дерева, деревянная основа. Кожаные чехлы для подлокотников с застежкой из латуни. Подушки сиденья и спинки наполнены натуральным пером и имеют полиуретановую прокладку. Механизм трансформации отсутствует.

实木框架；木制底座。马鞍罩风格真皮扶手，饰以黄铜扣。坐垫和靠背填充天然羽毛和聚氨酯泡沫。不可用作沙发床。

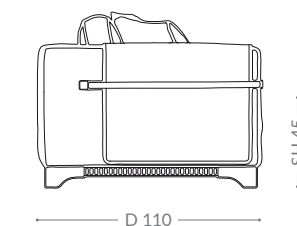
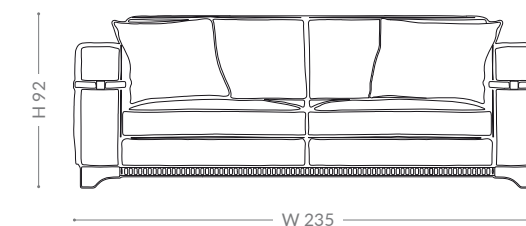

AMAZON 3 Posti/Seats/Сиденья/座位
2 cuscini inclusi
2 pillows included
2 подушки в комплекте
含 2 个抱枕

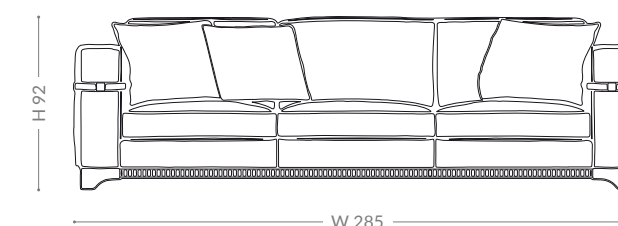

AMAZON 4 Posti/Seats/Сиденья/座位
3 cuscini inclusi
3 pillows included
3 подушки в комплекте
含 3 个抱枕

S O F A S

As picture: Amazon 4 seats
In price list: Prime/Brilliant

Divano/Sofa/Диван/沙发
BZ 187-127 VELVET SAND
BZ 904-4632 LEATHER SAND

Cuscini/Pillows/Подушки/抱枕
BZ 184-902 PALMA LIGHT BLU/BRASS
BZ 904-4632 LEATHER SAND
Lucidatura/Finishing/Отделка/饰面
55. COFFEE

Parti in metallo/Metal parts/Металлическая фурнитура/金属部件
TITANIUM

AMBASSADOR

SOFA



Struttura in legno massello. Copribracciolo in pelle ricamata. Cuscino schienale con ricamo. Cuscini di seduta e schienale in vera piuma con inserto in poliuretano. Meccanismo per divano letto non disponibile.

Solid wood frame. Quilted leather armrest saddle-covers. Quilted backrest cushion. Seat and back cushions in natural feather with polyurethane insert. Bed mechanism not available.

Каркас из массива дерева. Стеганные кожаные чехлы для подлокотников. Стеганая подушка спинки. Подушки сиденья и спинки наполнены натуральным пером и имеют полиуретановую прокладку. Механизм трансформации отсутствует.

实木框架。马鞍罩风格绗缝皮革扶手。绗缝靠背垫。坐垫和靠背填充天然羽毛和聚氨酯泡沫。不可用作沙发床。

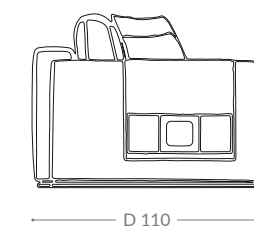
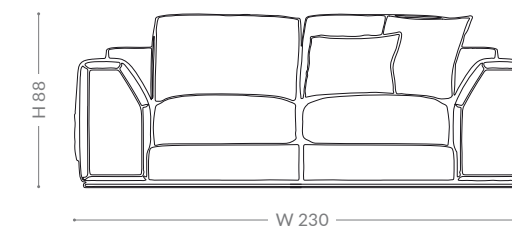

AMBASSADOR 3 Posti/Seats/
Сиденья/座位
2 cuscini inclusi
2 pillows included
2 подушки в комплекте
含 2 个抱枕

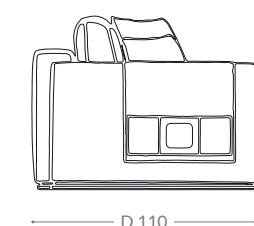
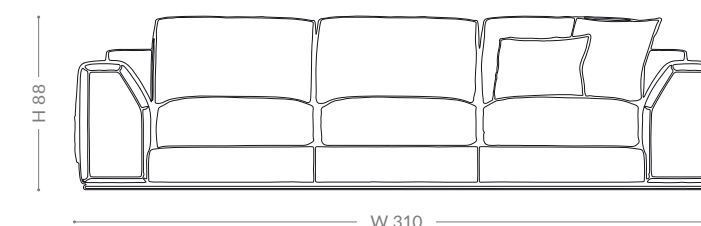

AMBASSADOR 4 Posti/Seats/
Сиденья/座位
2 cuscini inclusi
2 pillows included
2 подушки в комплекте
含 2 个抱枕

S O F A S

As picture: Ambassador 4 seats
In price list: Ambition/2
leather saddle-covers

Divano/Sofa/Диван/沙发
BZ 901-702 LEATHER DOVE GREY

Cuscini/Pillows/Подушки/抱枕
BZ 213-03 SHANTUNG PUTTY
BZ 901-702 LEATHER DOVE GREY

Lucidatura/Finishing/Отделка/饰面
89. TAUPE MATT

AMBASSADOR

MODULAR SOFA



Struttura in legno massello. Copribracciolo in pelle ricamata. Cuscino schienale con ricamo. Cuscini di seduta e schienale in vera piuma con inserto in poliuretano. Meccanismo per divano letto non disponibile.

Solid wood frame. Quilted leather armrest saddle-cover. Quilted backrest cushion. Seat and back cushions in natural feather with polyurethane insert. Bed mechanism not available.

Каркас из массива дерева. Стеганные кожаные чехлы для подлокотников. Стеганая подушка спинки. Подушки сиденья и спинки наполнены натуральным пером и имеют полиуретановую прокладку. Механизм трансформации отсутствует.

实木框架。马鞍罩风格绗缝皮革扶手。绗缝靠背垫。坐垫和靠背填充天然羽毛和聚氨酯泡沫。不可用作沙发床。



As picture: Ambassador modular (dormeuse + central element 3 seats + side table + side element 3 seats)
In price list: Prestige/leather saddle-cover

Divano/Sofa/Диван/沙发
BZ 191-001 JACQUARD BEIGE
BZ 905-5234 LEATHER BEIGE

Cuscini/Pillows/Подушки/抱枕
BZ 191-001 JACQUARD BEIGE
BZ 905-5234 LEATHER BEIGE

Lucidatura/Finishing/Отделка/饰面
81. SAND MATT
70. CANALETTO WALNUT MATT

AMBASSADOR

MODULAR SOFA

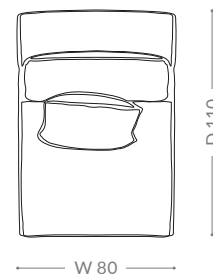
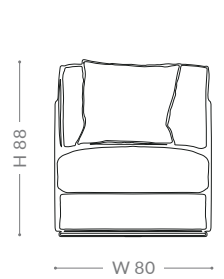

AMBASSADOR Elemento centrale 1 posto/
Central element 1 seat/Центральный
элемент с 1 сиденьем/中位组件 1 人位
1 cuscino incluso
1 pillow included
1 подушка в комплекте
含 1 个抱枕

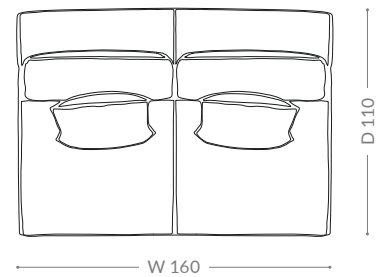
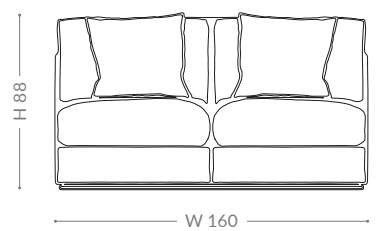

AMBASSADOR Elemento centrale 2 posti/
Central element 2 seats/Центральный
элемент с 2 сиденьями/中位组件 2 人位
2 cuscini inclusi
2 pillows included
2 подушки в комплекте
含 2 个抱枕

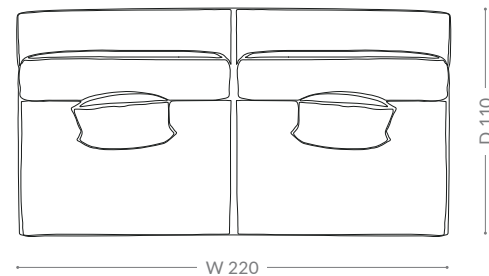
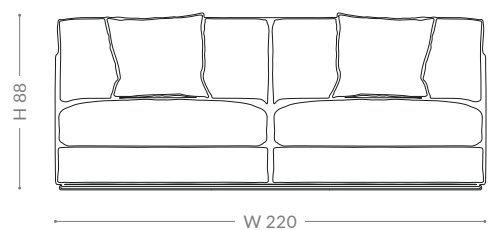

AMBASSADOR Elemento centrale 3 posti/
Central element 3 seats/Центральный
элемент с 3 сиденьями/中位组件 3 人位
2 cuscini inclusi
2 pillows included
2 подушки в комплекте
含 2 个抱枕

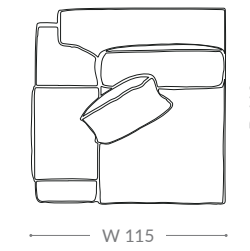
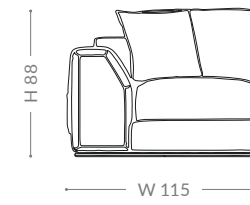

AMBASSADOR Elemento laterale 1 posto/
Side element 1 seat/Боковой элемент
с 1 сиденьем/侧位组件 1 人位
1 cuscino incluso
1 pillow included
1 подушка в комплекте
含 1 个抱枕

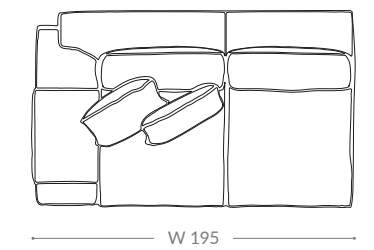
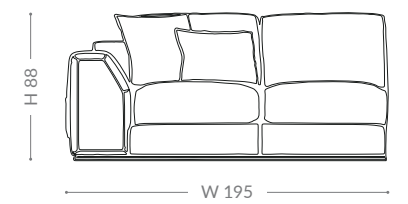

AMBASSADOR Elemento laterale 2 posti/
Side element 2 seats/Боковой элемент
с 2 сиденьями/侧位组件 2 人位
2 cuscini inclusi
2 pillows included
2 подушки в комплекте
含 2 个抱枕

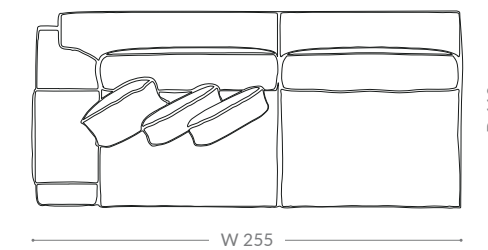
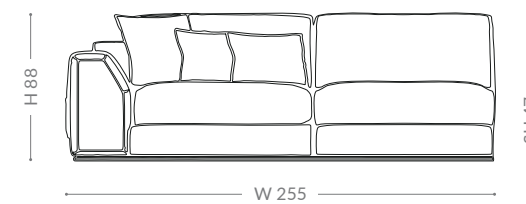

AMBASSADOR Elemento laterale 3 posti/
Side element 3 seats/Боковой элемент
с 3 сиденьями/侧位组件 3 人位
3 cuscini inclusi
3 pillows included
3 подушки в комплекте
含 3 个抱枕

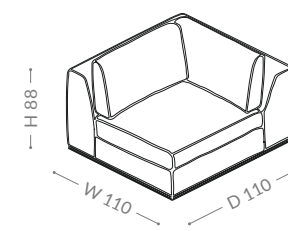

AMBASSADOR Elemento d'angolo/
Corner element/Угловой элемент/
转角组件
0 cuscini inclusi
0 pillows included
0 подушки в комплекте
含 0 个抱枕

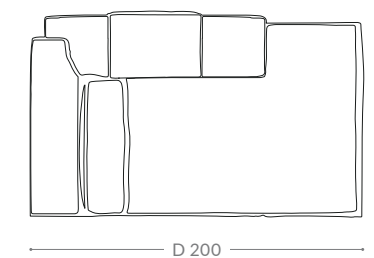
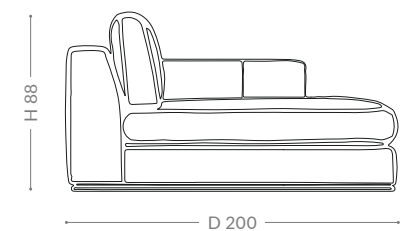

AMBASSADOR Dormeuse/
Dormeuse/Кушетка/沙发躺椅
0 cuscini inclusi
0 pillows included
0 подушки в комплекте
含 0 个抱枕

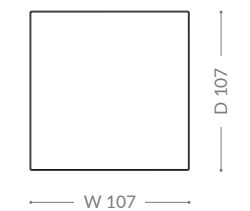
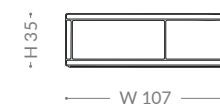

AMBASSADOR Tavolo quadrato/
Corner table/Угловой стол/角桌

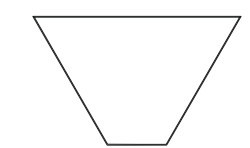
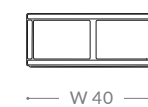
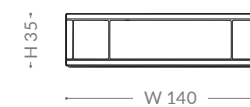

AMBASSADOR Tavolo trapezio/
Angular table/Многоугольный стол/
棱角桌

BABYLON

SOFA



Struttura in legno massello; basamento in legno. Schienale e braccioli capitonné. Cuscini di seduta in vera piuma con inserto in poliuretano. Disponibile con meccanismo per divano letto.

Solid wood frame; wooden base. Capitonné backrest and armrests. Seat cushions in natural feather with polyurethane insert. Available with bed mechanism.

Каркас из массива дерева, деревянная основа. Спинка и подлокотники с обивкой в виде каретной стяжки. Подушки сиденья наполнены натуральным пером и имеют полиуретановую прокладку. Есть механизм трансформации.

实木框架；木制底座。分块铆钉装饰（靠背和扶手）。坐垫填充天然羽毛和聚氨酯泡沫。可用作沙发床。

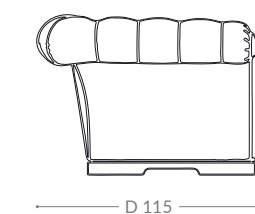
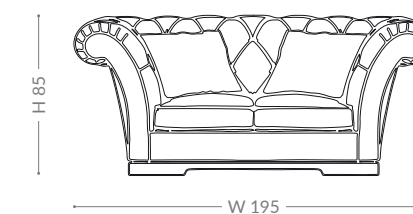

BABYLON 2 Posti/Seats/Сиденья/座位
2 cuscini inclusi
2 pillows included
2 подушки в комплекте
含 2 个抱枕

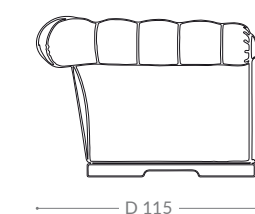
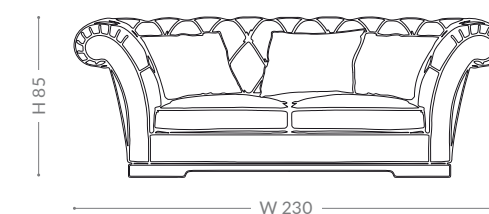

BABYLON 3 Posti/Seats/Сиденья/座位
3 cuscini inclusi
3 pillows included
3 подушки в комплекте
含 3 个抱枕

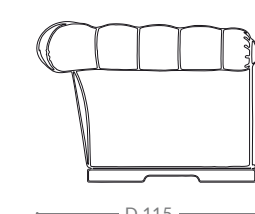
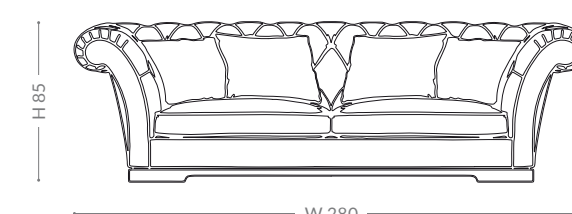

BABYLON 4 Posti/Seats/Сиденья/座位
4 cuscini inclusi
4 pillows included
4 подушки в комплекте
含 4 个抱枕

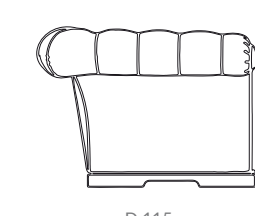
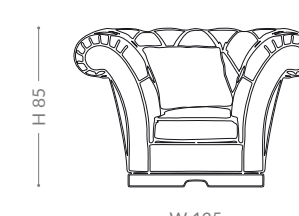

BABYLON Poltrona/Armchair/Кресло/扶手沙发椅
1 cuscino incluso
1 pillow included
1 подушка в комплекте
含 1 个抱枕

S O F A S

As picture: Babylon 4 seats
In price list: Ambition/Brilliant

Divano/Sofa/Диван/沙发
BZ 901-702 LEATHER DOVE GREY

Cuscini/Pillows/Подушки/抱枕
BZ 126-51 UNITO GREY PEARL
BZ 219-22 SATIN PLISSÉ GREY

Lucidatura/Finishing/Отделка/饰面
54. GREY

BARRYMORE

SOFA



Struttura in legno massello, basamento in legno di faggio. Esterno braccioli in pelle ricamata. Cuscini di seduta in vera piuma con inserto in poliuretano. Meccanismo per divano letto non disponibile.

Solid wood frame; wooden base. Leather decoration on outer armrests. Seat cushions in natural feather with polyurethane insert. Bed mechanism not available.

Каркас из массива дерева, основа из бука. Кожаная отделка внешней части подлокотников. Подушки сиденья наполнены натуральным пером и имеют полиуретановую прокладку. Механизм трансформации отсутствует.

实木框架；山毛榉底座。扶手外侧采用皮革装饰。坐垫填充天然羽毛和聚氨酯泡沫。不可用作沙发床。

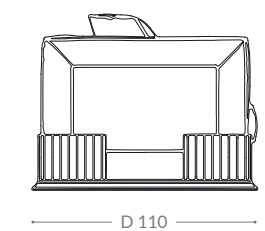
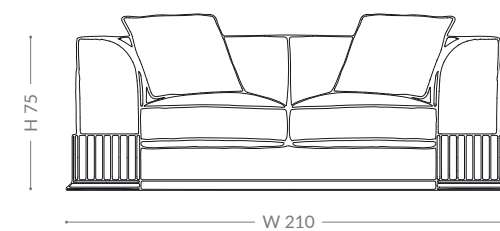

BARRYMORE 2 Posti/Seats/
Сиденья/座位
2 cuscini inclusi
2 pillows included
2 подушки в комплекте
含 2 个抱枕

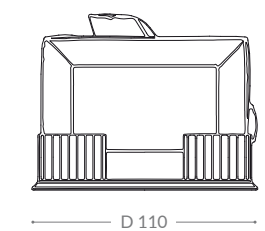
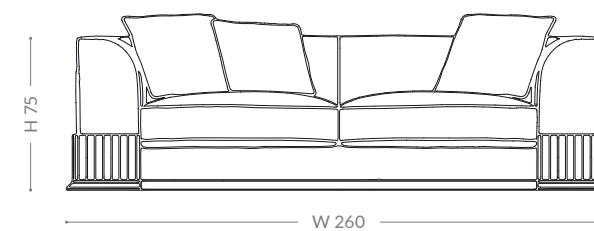

BARRYMORE 3 Posti/Seats/
Сиденья/座位
3 cuscini inclusi
3 pillows included
3 подушки в комплекте
含 3 个抱枕

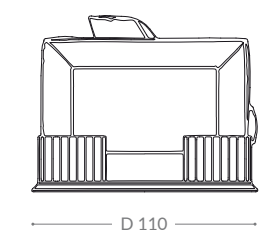
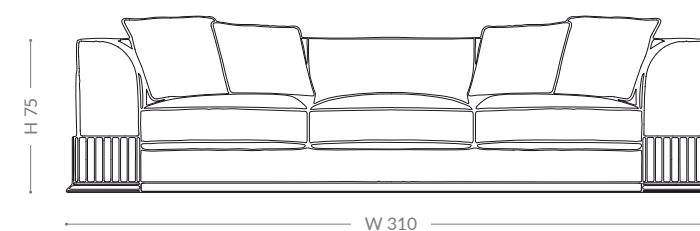

BARRYMORE 4 Posti/Seats/
Сиденья/座位
4 cuscini inclusi
4 pillows included
4 подушки в комплекте
含 4 个抱枕

S O F A S

As picture: Barrymore 3 seats
In price list: Prime/Brilliant

Divano/Sofa/Диван/沙发
BZ 187-161 VELVET BLUE GREY
BZ 901-501 LEATHER BLUE PRUSSIA

Cuscini/Pillows/Подушки/抱枕
BZ 170-901 PIXEL BLUE PRUSSIA
BZ 901-501 LEATHER BLUE PRUSSIA

Lucidatura/Finishing/Отделка/饰面
58. BLACK

BARRYMORE

MODULAR SOFA



Struttura in legno massello, basamento in legno di faggio. Esterno braccioli in pelle ricamata. Cuscini di seduta in vera piuma con inserto in poliuretano. Meccanismo per divano letto non disponibile.

Solid wood frame; wooden base. Leather decoration on outer armrests. Seat cushions in natural feather with polyurethane insert. Bed mechanism not available.

Каркас из массива дерева, основа из бука. Кожаная отделка внешней части подлокотников. Подушки сиденья наполнены натуральным пером и имеют полиуретановую прокладку. Механизм трансформации отсутствует.

实木框架; 山毛榉底座。扶手外侧采用皮革装饰。坐垫填充天然羽毛和聚氨酯泡沫。不可用作沙发床。

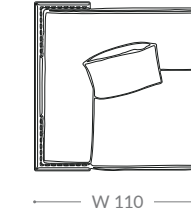
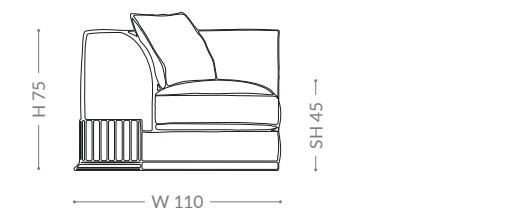

BARRYMORE Elemento laterale 1 posto
Side element 1 seat/Боковой элемент с 1 сиденьем/侧位组件 1 人位
1 cuscino incluso
1 pillow included
1 подушка в комплекте
含 1 个抱枕

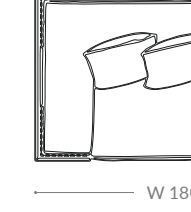
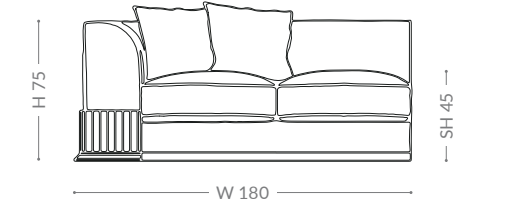

BARRYMORE Elemento laterale 2 posti
Side element 2 seats/Боковой элемент с 2 сиденьями/侧位组件 2 人位
2 cuscini inclusi
2 pillows included
2 подушки в комплекте
含 2 个抱枕

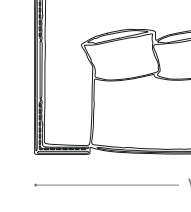
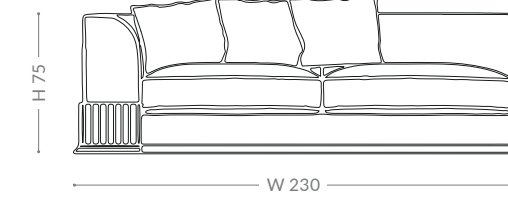

BARRYMORE Elemento laterale 3 posti
Side element 3 seats/Боковой элемент с 3 сиденьями/侧位组件 3 人位
3 cuscini inclusi
3 pillows included
3 подушки в комплекте
含 3 个抱枕

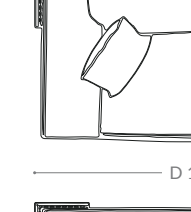
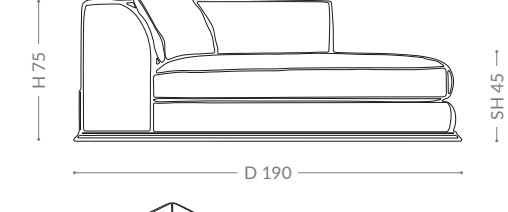

BARRYMORE Dormeuse/
Dormeuse/Кухетка/沙发躺椅
1 cuscino incluso
1 pillow included
1 подушка в комплекте
含 1 个抱枕

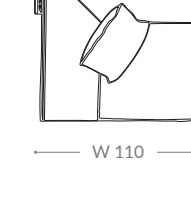
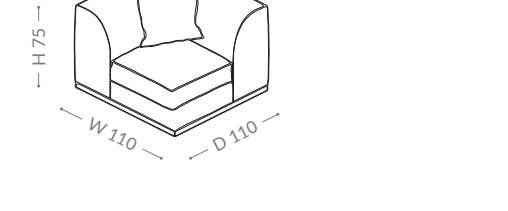

BARRYMORE Elemento d'angolo/
Corner element/Угловой элемент/转角组件
1 cuscino incluso
1 pillow included
1 подушка в комплекте
含 1 个抱枕

S O F A S

As picture: Barrymore modular (side element cm 180 + corner element + side element cm 230)
In price list: Prime/Brilliant

Divano/Sofa/Диван/沙发
BZ 187-127 VELVET SAND
BZ 901-432 LEATHER LIGHT BEIGE

Cuscini/Pillows/Подушки/抱枕
BZ 126-50 UNITO SAND/PEARL
BZ 183-901 RAILING WHITE/GOLD
BZ 187-127 VELVET SAND
BZ 901-432 LEATHER LIGHT BEIGE

Lucidatura/Finishing/Отделка/饰面
51. SAND

BAUHAUS

SOFA

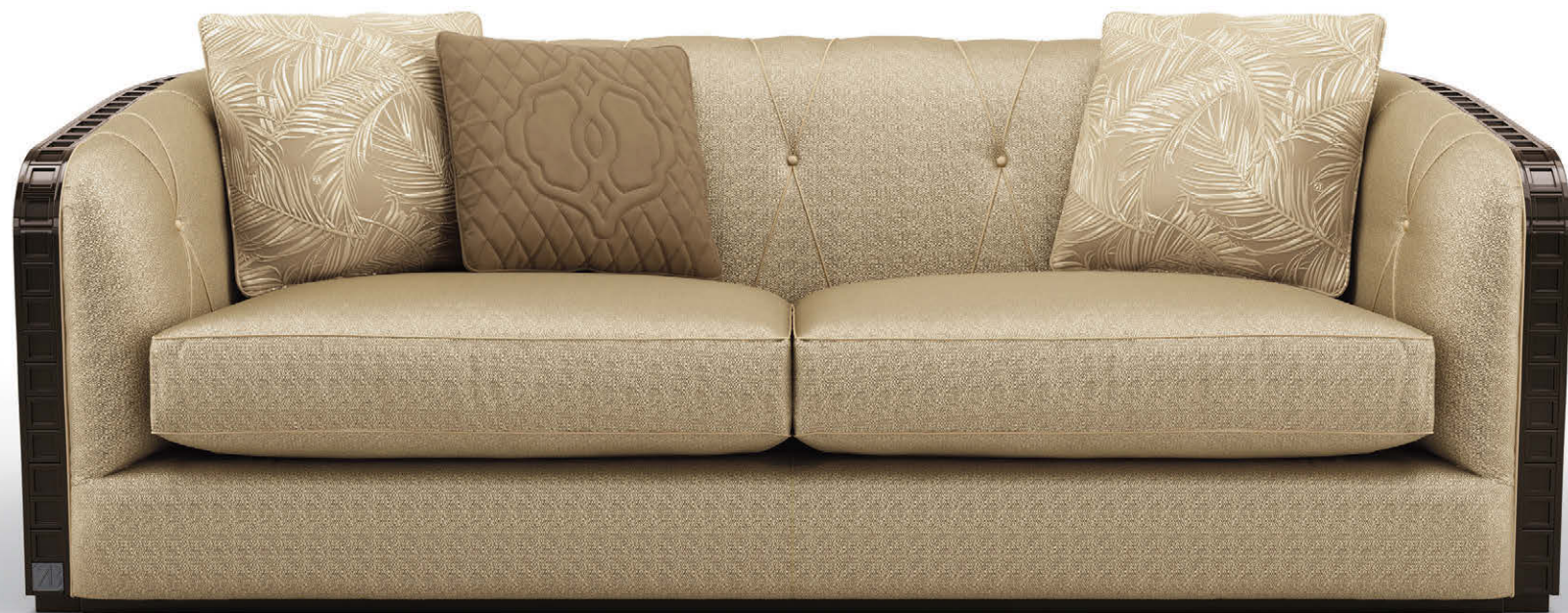

Struttura in legno massello. Schienale esterno in listellare/MDF con lavorazione verticale e decorazione in legno applicata sul perimetro. Schienale trapuntato a rombi con bottoni. Cuscini di seduta in vera piuma con inserto in poliuretano. Meccanismo per divano letto non disponibile.

Solid wood frame. Outer body in blockboard/MDF with fluted decoration. Wooden elements applied on the edge. Quilted backrest with buttons. Seat cushions in natural feather with polyurethane insert. Bed mechanism not available.

Каркас из массива дерева. Внешняя часть корпуса выполнена из столлярной плиты/МДФ с рельефной отделкой. Края украшены деревянными элементами. Стеганая спинка с пуговицами. Подушки сиденья наполнены натуральным пером и имеют полиуретановую прокладку. Механизм трансформации отсутствует.

实木框架。外侧部分为带凹槽装饰的细木工板/中密度纤维板。沙发边缘镶嵌木制组件。绗缝靠背（带纽扣）。坐垫填充天然羽毛和聚氨酯泡沫。不可用作沙发床。



S O F A S

As picture: Bauhaus 3 seats
In price list: Prestige/Brilliant

Divano/Sofa/Диван/沙发
BZ 188-07 BOUCLÉ SAND

Cuscini/Pillows/Подушки/抱枕
BZ 902-N8408 NABUK CHAMOIS
BZ 184-901 PALMA BEIGE/IVORY

Lucidatura/Finishing/Отделка/饰面
57. CHOCOLATE

BAUHAUS

SOFA

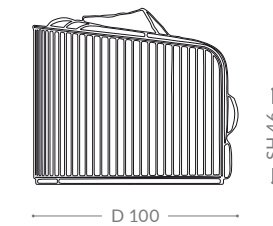
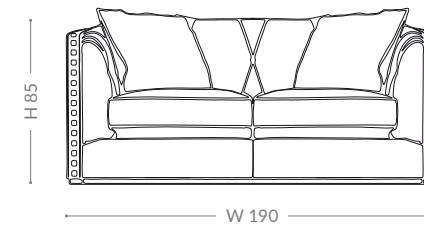

BAUHAUS 2 Posti/Seats/Сиденья/
座位
2 cuscini inclusi
2 pillows included
2 подушки в комплекте
含 2 个抱枕

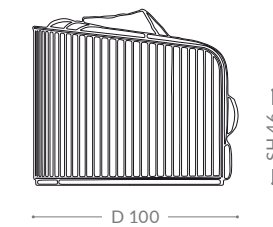
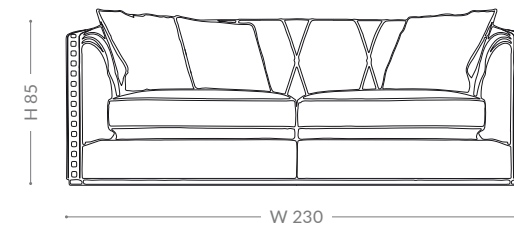

BAUHAUS 3 Posti/Seats/Сиденья/
座位
3 cuscini inclusi
3 pillows included
3 подушки в комплекте
含 3 个抱枕

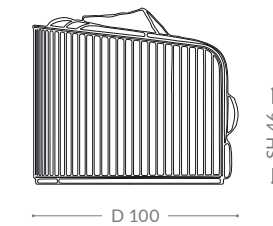
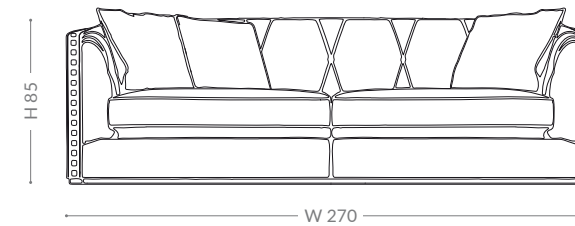

BAUHAUS 4 Posti/Seats/Сиденья/
座位
3 cuscini inclusi
3 pillows included
3 подушки в комплекте
含 3 个抱枕

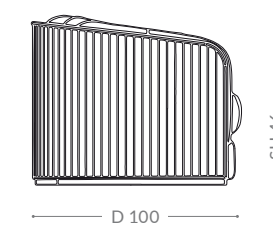
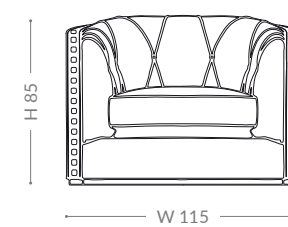

BAUHAUS Poltrona/Armchair/
Кресло/扶手沙发椅
0 cuscini inclusi
0 pillows included
0 подушки в комплекте
含 0 个抱枕

S O F A S

As picture: Bauhaus 3 seats
In price list: Prestige/Brilliant

Divano/Sofa/Диван/沙发
BZ 216-073 VELVET SAND

Cuscini/Pillows/Подушки/抱枕
BZ 126-52 UNITO IVORY

Lucidatura/Finishing/Отделка/饰面
51. SAND

CLUB

SOFA



Struttura in legno massello. Piedini in legno intagliati a mano; parte esterna in legno multistrati decorata con traforo. Cuscini di seduta e schienale in vera piuma con inserto in poliuretano. Meccanismo per divano letto non disponibile.

Solid wood frame. Hand-carved wooden feet; fretwork plywood outer frame. Seat and back cushions in natural feather with polyurethane insert. Bed mechanism not available.

Каркас из массива дерева. Деревянные ножки ручной работы, наружный резной каркас из фанеры. Подушки сиденья и спинки наполнены натуральным пером и имеют полиуретановую прокладку. Механизм трансформации отсутствует.

实木框架。木制沙发脚采用手工雕刻；外框采用浮雕胶合板。坐垫和靠背填充天然羽毛和聚氨酯泡沫。不可用作沙发床。



S O F A S

As picture: Club 3 seats
In price list: Prime/Brilliant

Divano/Sofa/Диван/沙发
BZ 187-131 VELVET TEAL
BZ 901-702 LEATHER DOVE GREY

Cuscini/Pillows/Подушки/抱枕
BZ 183-902 RAILING LIGHT BLUE/GOLD
BZ 188-06 BOUCLÉ TEAL

Lucidatura/Finishing/Отделка/饰面
54. GREY

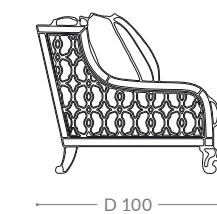
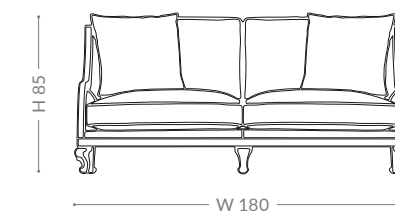

CLUB 2 Posti/Seats/Сиденья/座位
2 cuscini inclusi
2 pillows included
2 подушки в комплекте
含 2 个抱枕

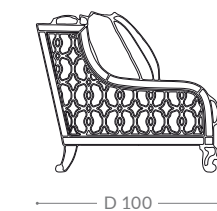
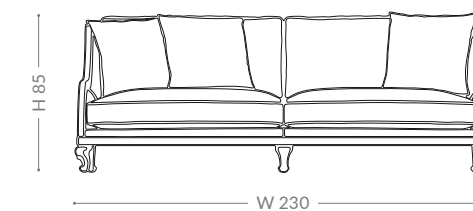

CLUB 3 Posti/Seats/Сиденья/座位
3 cuscini inclusi
3 pillows included
3 подушки в комплекте
含 3 个抱枕

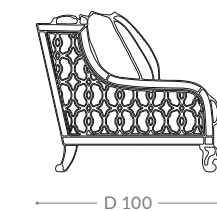
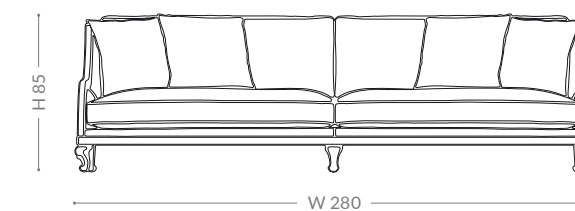

CLUB 4 Posti/Seats/Сиденья/座位
4 cuscini inclusi
4 pillows included
4 подушки в комплекте
含 4 个抱枕

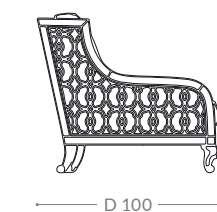
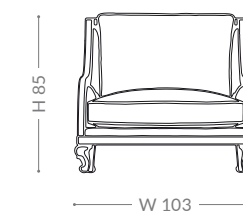

CLUB Poltrona/Armchair/Кресло/
扶手沙发椅
0 cuscini inclusi
0 pillows included
0 подушки в комплекте
含 0 个抱枕

COCÒ

SOFA



Struttura in legno massello. Fascia perimetrale in legno di faggio sagomato. Parte esterna capitonné. Cuscini di seduta in vera piuma con inserto in poliuretano. Meccanismo per divano letto non disponibile.

Solid wood frame. Outer profile band in shaped wood. Capitoné outer body. Seat cushions in natural feather with polyurethane insert. Bed mechanism not available.

Каркас из массива дерева. Фигурная наружная полоса профиля из бука. Внешняя часть корпуса с обивкой в виде каретной стяжки. Подушки сиденья наполнены натуральным пером и имеют полиуретановую прокладку. Механизм трансформации отсутствует.

实木框架。外部轮廓为山毛榉型材镶边。外侧部分采用分块铆钉装饰。坐垫填充天然羽毛和聚氨酯泡沫。不可用作沙发床。

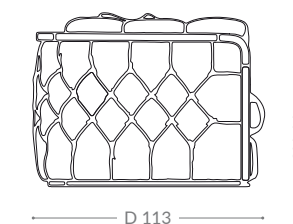
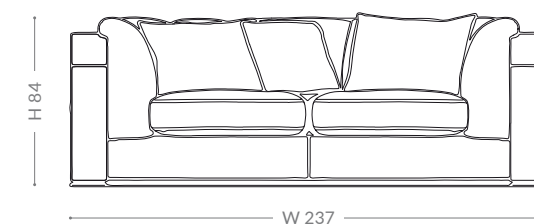

COCÒ 3 Posti/Seats/Сиденья/座位
3 cuscini inclusi
3 pillows included
3 подушки в комплекте
含 3 个抱枕

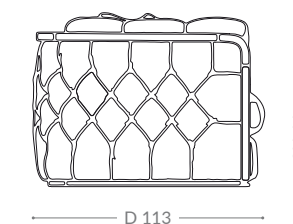
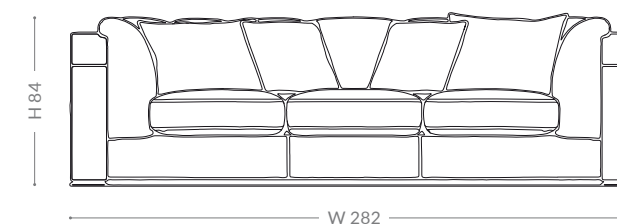

COCÒ 4 Posti/Seats/Сиденья/座位
4 cuscini inclusi
4 pillows included
4 подушки в комплекте
含 4 个抱枕

S O F A S

As picture: Cocò 4 seats
In price list: Prime/Brilliant

Divano/Sofa/Диван/沙发
BZ 187-147 VELVET HAZELNUT
BZ 904-4632 LEATHER SAND

Cuscini/Pillows/Подушки/抱枕
BZ 126-50 UNITO SAND/PEARL
BZ 904-4632 LEATHER SAND

Lucidatura/Finishing/Отделка/饰面
57. CHOCOLATE

DAVIS

SOFA



Struttura in legno massello; basamento in legno. Schienale e braccioli capitonné. Cuscini di seduta in vera piuma con inserto in poliuretano. Meccanismo per divano letto non disponibile.

Solid wood frame; wooden base. Capitonné backrest and armrests. Seat cushions in natural feather with polyurethane insert. Bed mechanism not available.

Каркас из массива дерева, деревянная основа. Спинка и подлокотники с обивкой в виде каретной стяжки. Подушки сиденья наполнены натуральным пером и имеют полиуретановую прокладку. Механизм трансформации отсутствует.

实木框架；木制底座。分块铆钉装饰（靠背和扶手）。坐垫填充天然羽毛和聚氨酯泡沫。不可用作沙发床。



S O F A S

As picture: Davis 3 seats
In price list: Ambition/Brilliant

Divano/Sofa/Диван/沙发
BZ 901-891 LEATHER IVORY

Cuscini/Pillows/Подушки/抱枕
BZ 126-52 UNITO IVORY
BZ 171-901 MATELASSÉ IVORY

Lucidatura/Finishing/Отделка/饰面
51. SAND

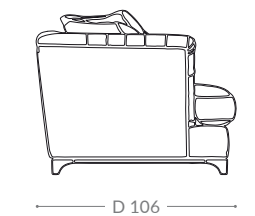
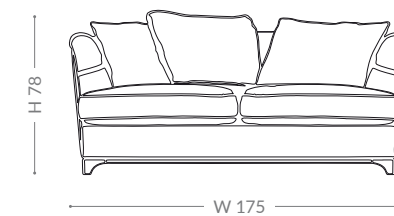

DAVIS 2 Posti/Seats/Сиденья/座位
3 cuscini inclusi
3 pillows included
3 подушки в комплекте
含 3 个抱枕

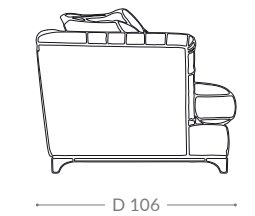
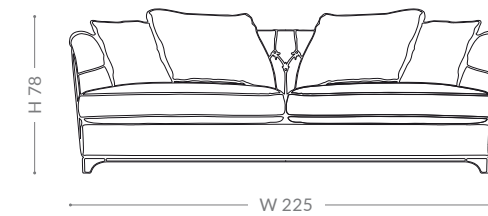

DAVIS 3 Posti/Seats/Сиденья/座位
4 cuscini inclusi
4 pillows included
4 подушки в комплекте
含 4 个抱枕

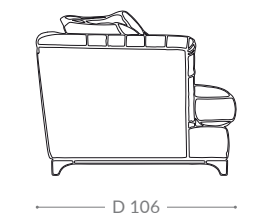
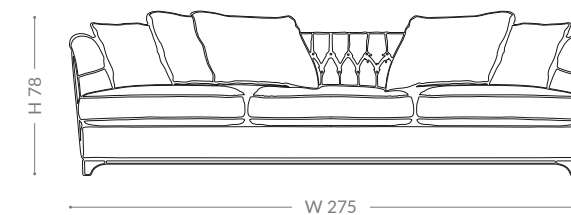

DAVIS 4 Posti/Seats/Сиденья/座位
5 cuscini inclusi
5 pillows included
5 подушки в комплекте
含 5 个抱枕

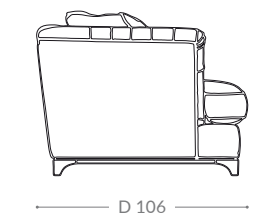
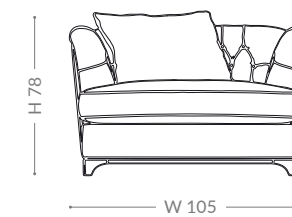

DAVIS Poltrona/Armchair/Кресло/
扶手沙发椅
1 cuscino incluso
1 pillow included
1 подушка в комплекте
含 1 个抱枕

DAVIS

MODULAR SOFA



Struttura in legno massello; basamento in legno. Schienale e braccioli capitonné. Cuscini di seduta in vera piuma con inserto in poliuretano. Meccanismo per divano letto non disponibile.

Solid wood frame; wooden base. Capitonné backrest and armrests. Seat cushions in natural feather with polyurethane insert. Bed mechanism not available.

Каркас из массива дерева, деревянная основа. Спинка и подлокотники с обивкой в виде каретной стяжки. Подушки сиденья наполнены натуральным пером и имеют полиуретановую прокладку. Механизм трансформации отсутствует.

实木框架; 木制底座。分块铆钉装饰 (靠背和扶手)。坐垫填充天然羽毛和聚氨酯泡沫。不可用作沙发床。

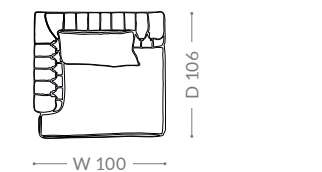

DAVIS Elemento laterale
1 posto/Side element 1
seat /Боковой элемент с
1 сиденьем/侧位组件 1 人位

1 cuscino incluso
1 pillow included
1 подушка в комплекте
含 1 个抱枕

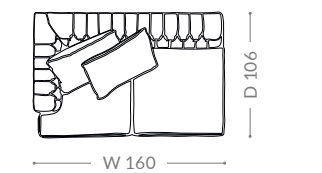
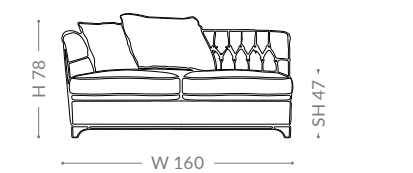

DAVIS Elemento laterale
2 posti/Side element 2
seats/Боковой элемент с
2 сиденьями/侧位组件 2 人位

2 cuscini inclusi
2 pillows included
2 подушки в комплекте
含 2 个抱枕

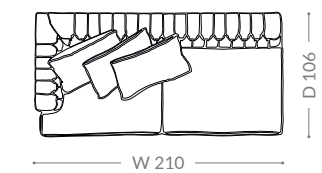
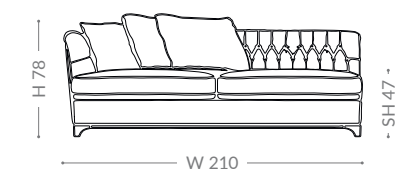

DAVIS Elemento laterale
3 posti/Side element 3
seats/Боковой элемент с
3 сиденьями/侧位组件 3 人位

3 cuscini inclusi
3 pillows included
3 подушки в комплекте
含 3 个抱枕

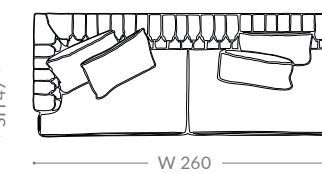
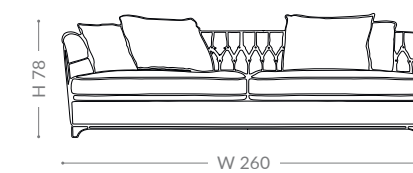

DAVIS Elemento laterale
4 posti/Side element 4
seats/Боковой элемент с
4 сиденьями/侧位组件 4 人位

4 cuscini inclusi
4 pillows included
4 подушки в комплекте
含 4 个抱枕

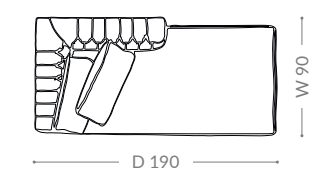
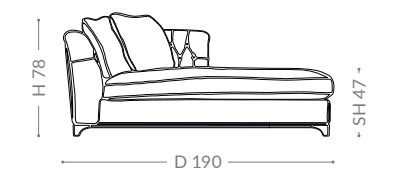

DAVIS Dormeuse/Dormeuse/
Кухетка/沙发躺椅

2 cuscini inclusi
2 pillows included
2 подушки в комплекте
含 2 个抱枕

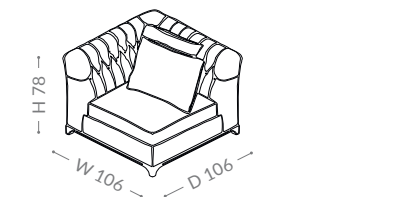

DAVIS Elemento d'angolo/
Corner element/Угловой
элемент/转角组件

2 cuscini inclusi
2 pillows included
2 подушки в комплекте
含 2 个抱枕

EMPERADOR

SOFA

Struttura in legno massello.
Parte esterna capitonné.
Cuscini di seduta in vera piuma
con inserto in poliuretano.
Meccanismo per divano letto
disponibile.

Solid wood frame. Capitonné
outer body. Seat cushions
in natural feather with
polyurethane insert. Available
with bed mechanism.

Каркас из массива дерева.
Внешняя часть корпуса с
обивкой в виде каретной
стяжки. Подушки сиденья
наполнены натуральным
пером и имеют полиуретано-
вую прокладку. Есть меха-
низм трансформации.

实木框架。外侧部分采用分块
铆钉装饰。坐垫填充天然羽毛
和聚氨酯泡沫。可用作沙发
床。



S O F A S

As picture: Emperador 4 seats
In price list: Prime

Divano/Sofa/Диван/沙发
BZ 200-803 VELVET GREY
BZ 905-5230 LEATHER GREY

Cuscini/Pillows/Подушки/抱枕
BZ 192-003 CHEVRON GREY
BZ 184-904 PALMA GREY

Lucidatura/Finishing/Отделка/饰面
83. DUST GREY MATT

EMPERADOR

SOFA



S O F A S

As picture: Emperor 4 seats
In price list: Prestige

Divano/Sofa/Диван/沙发
BZ 211-1120 VELVET MELANGE BURGUNDY
BZ 906-2030 LEATHER BURGUNDY

Cuscini/Pillows/Подушки/抱枕
BZ 216-120 VELVET RHUBARB
BZ 906-2030 LEATHER BURGUNDY

Lucidatura/Finishing/Отделка/饰面
85. CHOCOLATE MATT

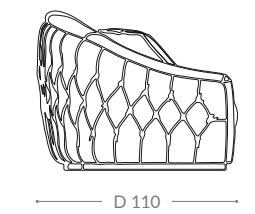
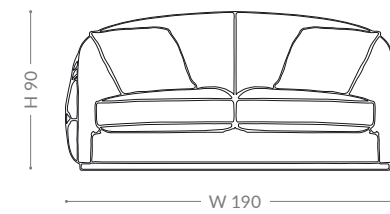

EMPERADOR 2 Posti/Seats/
Сиденья/座位
2 cuscini inclusi
2 pillows included
2 подушки в комплекте
含 2 个抱枕

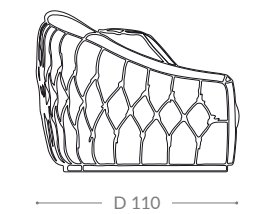
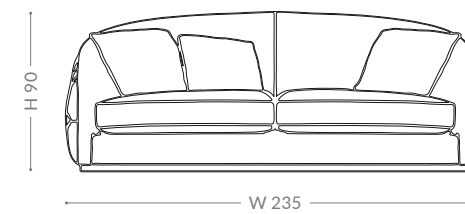

EMPERADOR 3 Posti/Seats/
Сиденья/座位
3 cuscini inclusi
3 pillows included
3 подушки в комплекте
含 3 个抱枕

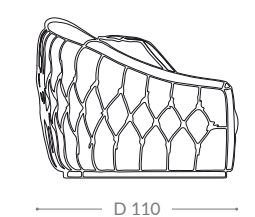
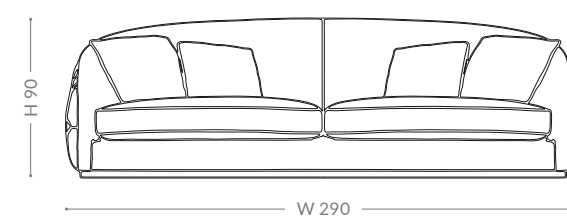

EMPERADOR 4 Posti/Seats/
Сиденья/座位
4 cuscini inclusi
4 pillows included
4 подушки в комплекте
含 4 个抱枕

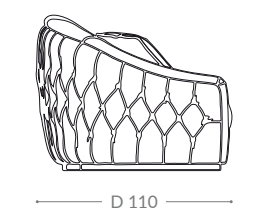
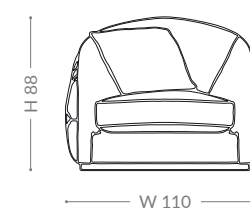

EMPERADOR Poltrona/Armchair/
Кресло/扶手沙发椅
1 cuscino incluso
1 pillow included
1 подушка в комплекте
含 1 个抱枕

FLY

SOFA



Struttura in legno massello; basamento in legno di faggio sagomato. Cuscini di seduta in vera piuma con inserto in poliuretano. Meccanismo per divano letto non disponibile.

Solid wood frame; shaped wooden base. Seat cushions in natural feather with polyurethane insert. Bed mechanism not available.

Каркас из массива дерева, фигурная основа из бука. Подушки сиденья наполнены натуральным пером и имеют полиуретановую прокладку. Механизм трансформации отсутствует.

实木框架；山毛榉型材底座。坐垫填充天然羽毛和聚氨酯泡沫。不可用作沙发床。



S O F A S

As picture: Fly 3 seats
In price list: Prime/Brilliant

Divano/Sofa/Диван/沙发
BZ 187-125 VELVET DOVE GREY

Cuscini/Pillows/Подушки/抱枕
BZ 126-51 UNITO GREY/PEARL
BZ 117-03 SMALL SILVER HEXAGON
BZ 901-702 LEATHER DOVE GREY

Lucidatura/Finishing/Отделка/饰面
54. GREY

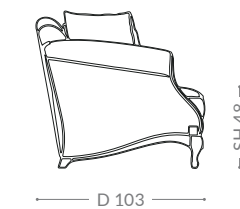
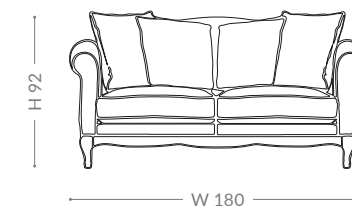

FLY 2 Posti/Seats/Сиденья/座位
4 cuscini inclusi
4 pillows included
4 подушки в комплекте
含 4 个抱枕

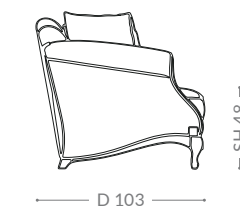
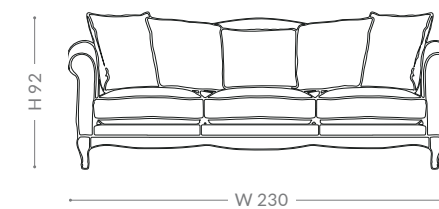

FLY 3 Posti/Seats/Сиденья/座位
5 cuscini inclusi
5 pillows included
5 подушки в комплекте
含 5 个抱枕

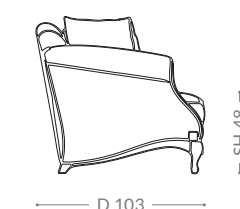
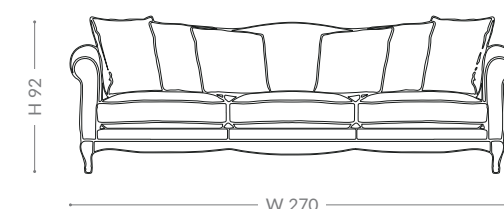

FLY 4 Posti/Seats/Сиденья/座位
6 cuscini inclusi
6 pillows included
6 подушки в комплекте
含 6 个抱枕

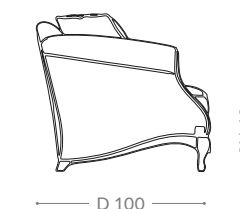
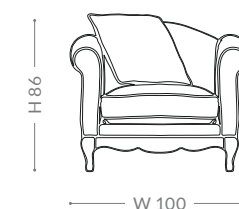

FLY Poltrona/Armchair/Кресло/
扶手沙发椅
1 cuscino incluso
1 pillow included
1 подушка в комплекте
含 1 个抱枕

GATSBY

SOFA

Struttura in legno massello; basamento e parti lucidate in legno di faggio. Cuscini di seduta in vera piuma con inserto in poliuretano. Meccanismo per divano letto non disponibile.

Solid wood frame; polished parts and base in beechwood. Seat cushions in natural feather with polyurethane insert. Bed mechanism not available.

Каркас из массива дерева, глянцевые детали и основа из бука. Подушки сиденья наполнены натуральным пером и имеют полиуретановую прокладку. Механизм трансформации отсутствует.

实木框架；抛光部件，山毛榉底座。坐垫填充天然羽毛和聚氨酯泡沫。不可用作沙发床。



S O F A S

As picture: Gatsby 3 seats
In price list: Prestige/Brilliant

Divano/Sofa/Диван/沙发
BZ 171-901 MATELASSÉ IVORY
BZ 901-332 LEATHER BUTTER

Cuscini/Pillows/Подушки/抱枕
BZ 170-901 PIXEL BLUE PRUSSIA
BZ 902 NABUK BLUE

Lucidatura/Finishing/Отделка/饰面
57. CHOCOLATE

GATSBY

SOFA



S O F A S

As picture: Gatsby 4 seats
In price list: Prime

Divano/Sofa/Диван/沙发
BZ 187-125 VELVET DOVE GREY
BZ 901-702 LEATHER DOVE GREY

Cuscini/Pillows/Подушки/抱枕
BZ 901-702 LEATHER DOVE GREY
BZ 126-51 UNITO GREY/PEARL

Lucidatura/Finishing/Отделка/饰面
100. GREY MATT

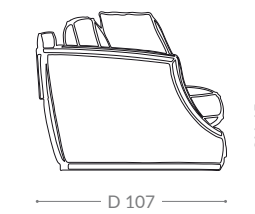
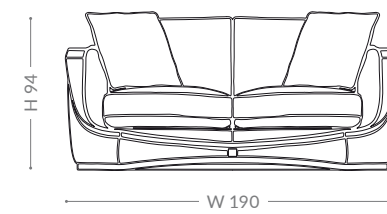

GATSBY 2 Posti/Seats/Сиденья/座位
2 cuscini inclusi
2 pillows included
2 подушки в комплекте
含 2 个抱枕

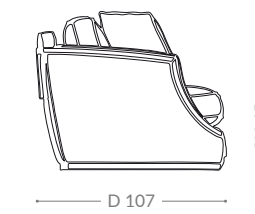
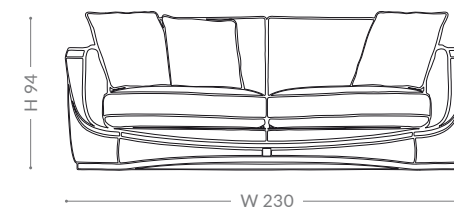

GATSBY 3 Posti/Seats/Сиденья/座位
3 cuscini inclusi
3 pillows included
3 подушки в комплекте
含 3 个抱枕

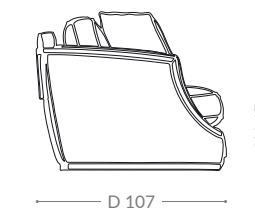
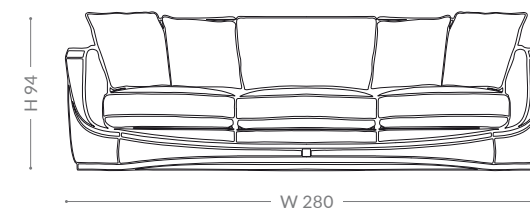

GATSBY 4 Posti/Seats/Сиденья/座位
4 cuscini inclusi
4 pillows included
4 подушки в комплекте
含 4 个抱枕

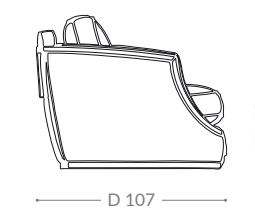
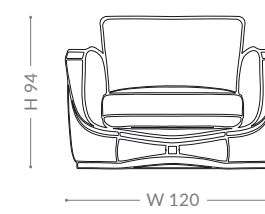

GATSBY Poltrona/Armchair/
Кресло/扶手沙发椅
0 cuscini inclusi
0 pillows included
0 подушки в комплекте
含 0 个抱枕

GIASONE

SOFA

Struttura in legno massello. Parte esterna decorata a rombi. Cuscini seduta e schienale in poliuretano a quote differenziate. Meccanismo per divano letto non disponibile.

Solid wood frame. Quilted outer body. Multiple densities polyurethane foam seating and backrest. Bed mechanism not available.

Каркас из массива дерева. Стеганая внешняя часть корпуса. Пенополиуретан разной плотности. Механизм трансформации отсутствует.

实木框架。外侧部分绗缝。多重密度聚氨酯泡沫。不可用作沙发床。



S O F A S

As picture: Giasone 4 seats
In price list: Exclusive/Brilliant

Divano/Sofa/Диван/沙发
BZ 203-004 BOUCLÉ TIFFANY
BZ 906-2006 LEATHER TAUPE

Cuscini/Pillows/Подушки/抱枕
BZ 205-027 VELVET TIFFANY
BZ 204-695 JACQUARD TIFFANY

Lucidatura/Finishing/Отделка/饰面
54. GREY

GIASONE
SOFA

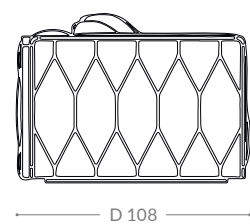
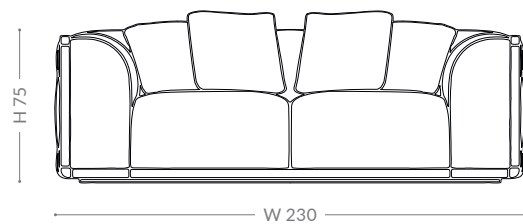

GIASONE 3 Posti/Seats/Сиденья/
座位
4 cuscini inclusi
4 pillows included
4 подушки в комплекте
含 4 个抱枕

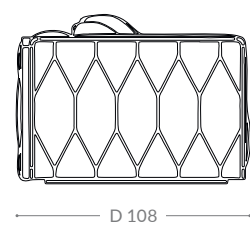
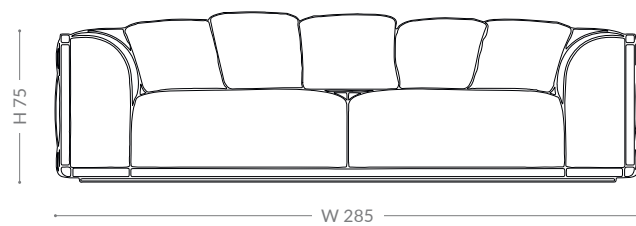

GIASONE 4 Posti/Seats/Сиденья/
座位
5 cuscini inclusi
5 pillows included
5 подушки в комплекте
含 5 个抱枕

GIASONE
MODULAR SOFA



As picture: Giasone modular
(2 side elements cm 200 + side table)
In price list: Prestige/Brilliant

Divano/Sofa/Диван/沙发
BZ 205-017 VELVET BEIGE
BZ 905-5234 LEATHER BEIGE

Cuscini/Pillows/Подушки/抱枕
BZ 214-03 VELVET CARVED BLUE
BZ 905-5234 LEATHER BEIGE

Lucidatura/Finishing/
Отделка/饰面
57. CHOCOLATE

Struttura in legno massello.
Parte esterna decorata a rombi.
Cuscini seduta e schienale
in poliuretano a quote
differenziate. Meccanismo per
divano letto non disponibile.

Solid wood frame. Quilted
outer body. Multiple densities
polyurethane foam seating and
backrest. Bed mechanism not
available.

Каркас из массива дерева.
Стеганая внешняя часть
корпуса. Пенополиуретан
разной плотности. Механизм
трансформации отсутствует.

实木框架。外侧部分绗缝。多
重密度聚氨酯泡沫。不可用作
沙发床。

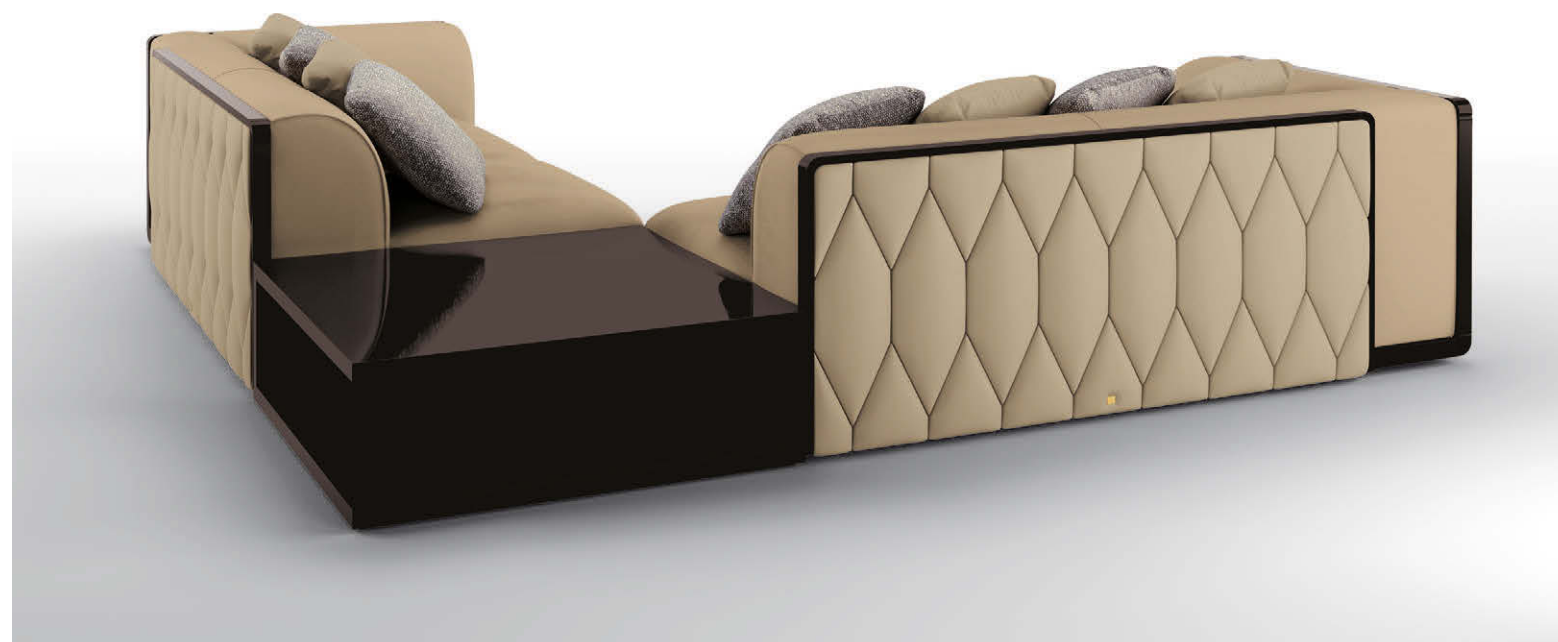

GIASONE

MODULAR SOFA

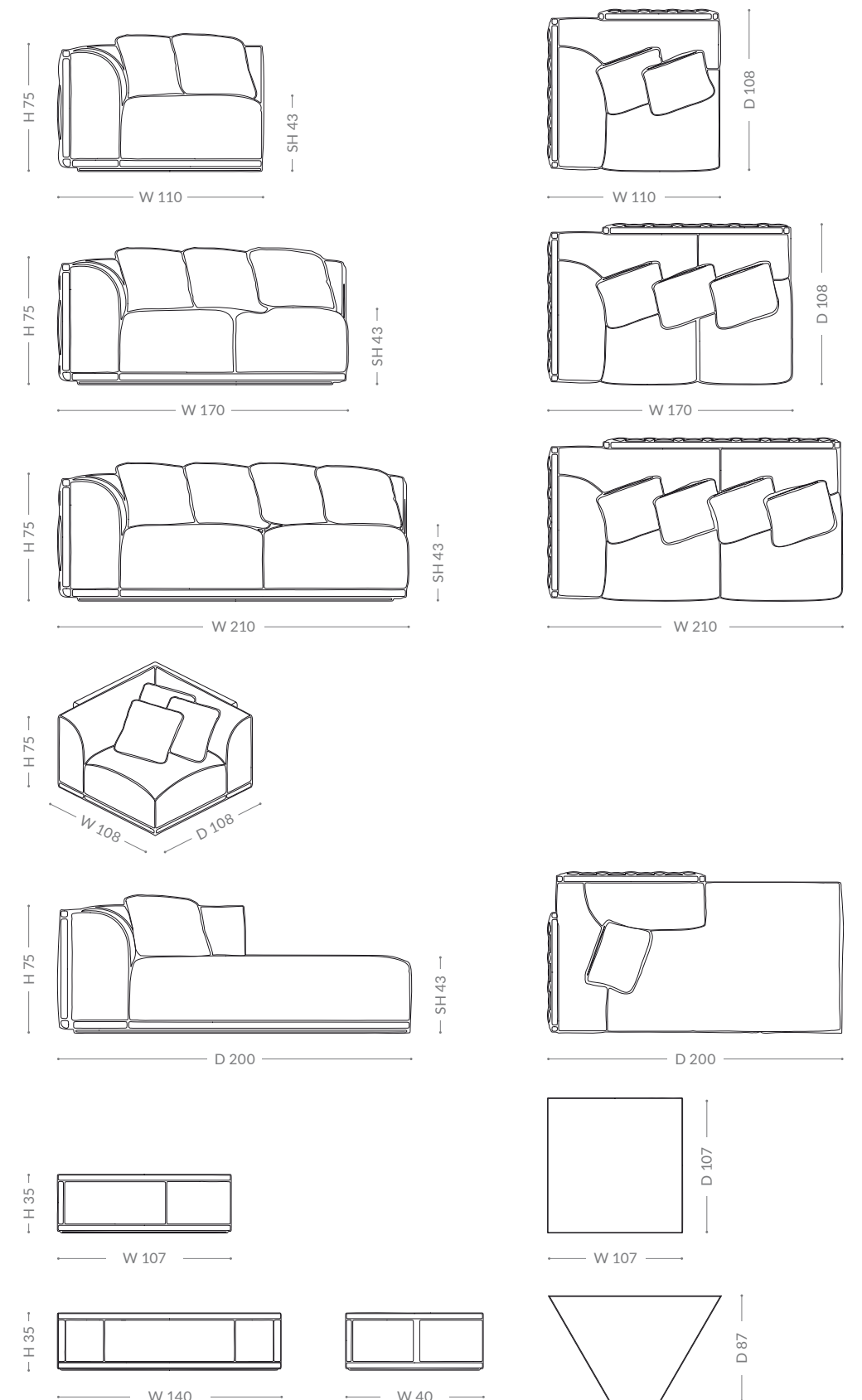

GIASONE Elemento laterale 1 posto/
Side element 1 seat/Боковой элемент
с 1 сиденьем/侧位组件 1 人位
2 cuscini inclusi
2 pillows included
2 подушки в комплекте
含 2 个抱枕

GIASONE Elemento laterale 2 posti/
Side element 2 seats/Боковой элемент
с 2 сиденьями/侧位组件 2 人位
3 cuscini inclusi
3 pillows included
3 подушки в комплекте
含 3 个抱枕

GIASONE Elemento laterale 3 posti/
Side element 3 seats/Боковой элемент
с 3 сиденьями/侧位组件 3 人位
4 cuscini inclusi
4 pillows included
4 подушки в комплекте
含 4 个抱枕

GIASONE Elemento d'angolo/Cor-
ner element/Угловой элемент/转
角组件
3 cuscini inclusi
3 pillows included
3 подушки в комплекте
含 3 个抱枕

GIASONE Dormeuse/Dormeuse/
Кушетка/沙发躺椅
1 cuscino incluso
1 pillow included
1 подушка в комплекте
含 1 个抱枕

GIASONE Tavolo quadrato/Corner
table/Угловой стол/角桌

GIASONE Tavolo trapezio/Angular
table/Многоугольный стол/棱角桌

GORDON

SOFA

Struttura in legno massello; basamento in legno di faggio. Parte interna trapuntata a righe verticali. Cuscini di seduta in vera piuma con inserto in poliuretano. Meccanismo per divano letto disponibile.

Solid wood frame; shaped beechwood base. Vertically decorated quilted inner body. Seat cushions in natural feather with polyurethane insert. Available with bed mechanism.

Каркас из массива дерева, фигурная основа из бука. Стеганая внутренняя часть корпуса имеет вертикальную отделку. Подушки сиденья наполнены натуральным пером и имеют полиуретановую прокладку. Есть механизм трансформации.

实木框架；山毛榉型材底座。内侧部分采用竖直装饰纹缝。坐垫填充天然羽毛和聚氨酯泡沫。可用作沙发床。



S O F A S

As picture: Gordon 3 seats
In price list: Prestige/Brilliant

Divano/Sofa/Диван/沙发
BZ 188-06 BOUCLÉ TEAL

Cuscini/Pillows/Подушки/抱枕
BZ 184-902 PALMA LIGHT BLUE/BRASS
BZ 188-06 BOUCLÉ TEAL

Lucidatura/Finishing/Отделка/饰面
55. COFFEE

GORDON
SOFA

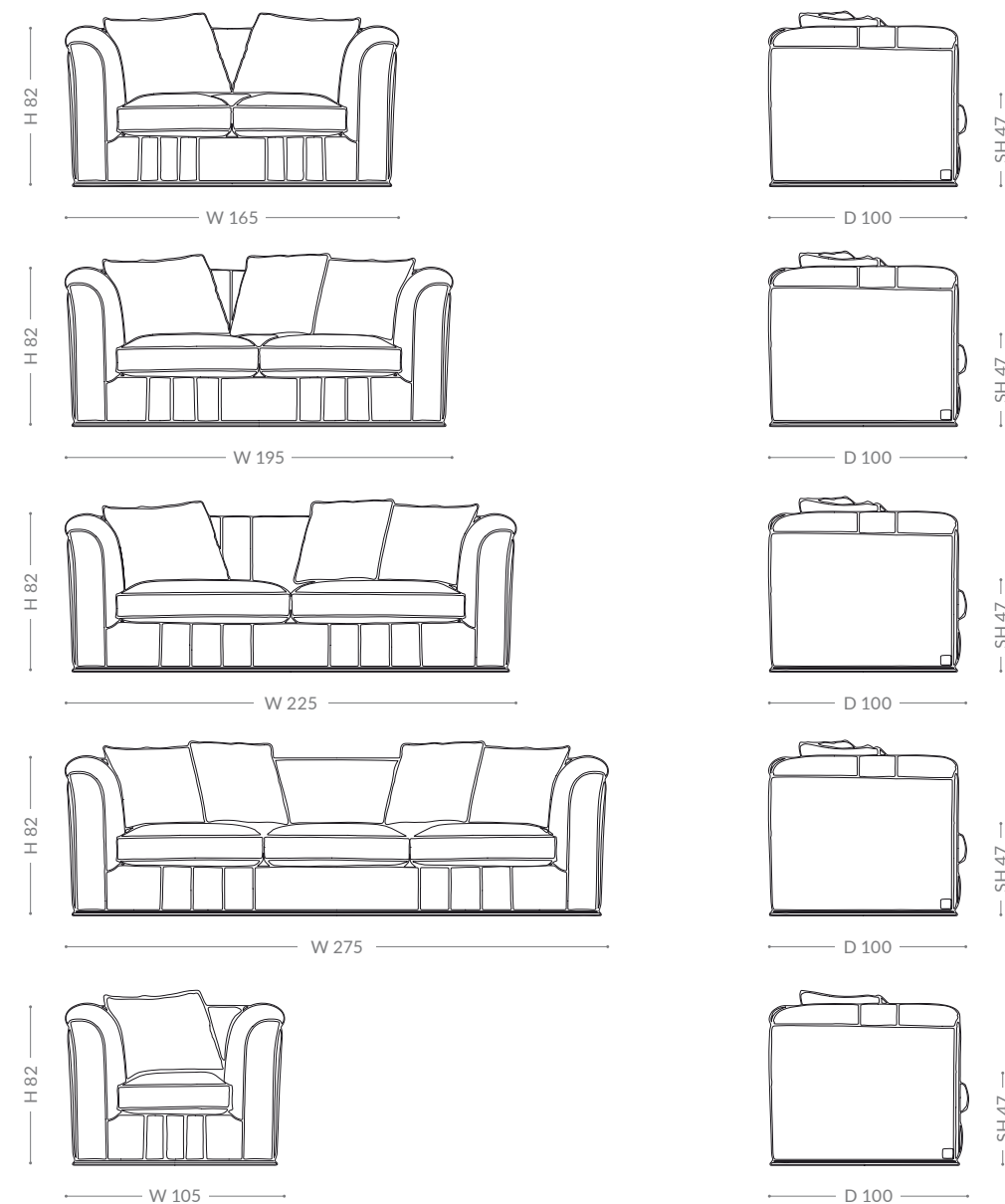

GORDON 2 Posti/Seats/Сиденья/
座位
2 cuscini inclusi
2 pillows included
2 подушки в комплекте
含 2 个抱枕

GORDON 2,5 Posti/Seats/Сиденья/
座位
3 cuscini inclusi
3 pillows included
3 подушки в комплекте
含 3 个抱枕

GORDON 3 Posti/Seats/Сиденья/
座位
3 cuscini inclusi
3 pillows included
3 подушки в комплекте
含 3 个抱枕

GORDON 4 Posti/Seats/Сиденья/
座位
4 cuscini inclusi
4 pillows included
4 подушки в комплекте
含 4 个抱枕

GORDON Poltrona/Armchair/
Кресло/扶手沙发椅
1 cuscino incluso
1 pillow included
1 подушка в комплекте
含 1 个抱枕

GORDON
MODULAR SOFA



As picture: Gordon modular
(side element cm 200 + dormeuse)
In price list: Prime/Brilliant

Divano/Sofa/Диван/沙发
BZ 187-127 VELVET SAND

Cuscini/Pillows/Подушки/抱枕
BZ 183-901 RAILING WHITE/GOLD
BZ 145-001 BOUCLÉ IVORY/BEIGE/GOLD
BZ 904-4632 LEATHER SAND

Lucidatura/Finishing/
Отделка/饰面
51. SAND

Struttura in legno massello; basamento in legno. Parte interna trapuntata a righe verticali. Cuscini di seduta in vera piuma con inserto in poliuretano. Meccanismo per divano letto disponibile.

Solid wood frame; shaped beechwood base. Vertically decorated quilted inner body. Seat cushions in natural feather with polyurethane insert. Available with bed mechanism.

Каркас из массива дерева, фигурная основа из бука. Стеганая внутренняя часть корпуса имеет вертикальную отделку. Подушки сиденья наполнены натуральным пером и имеют полиуретановую прокладку. Есть механизм трансформации.

实木框架；山毛榉型材底座。内侧部分采用竖直装饰纹缝。坐垫填充天然羽毛和聚氨酯泡沫。可用作沙发床。



GORDON

MODULAR SOFA

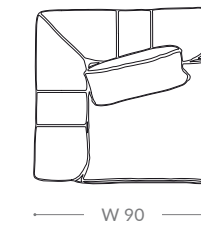
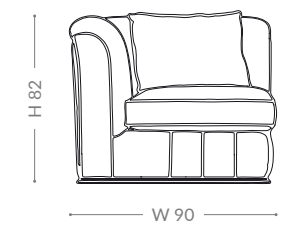

GORDON Elemento laterale 1 posto/
Side element 1 seat/Боковой элемент
с 1 сиденьем/侧位组件 1 人位
1 cuscino incluso
1 pillow included
1 подушка в комплекте
含 1 个抱枕

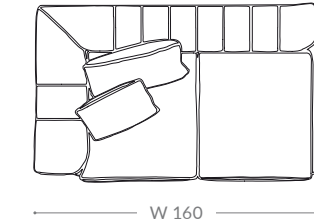
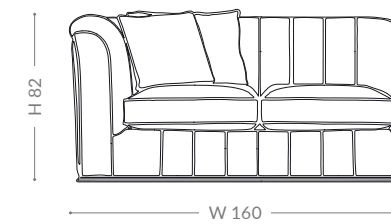

GORDON Elemento laterale 2 posti/
Side element 2 seats/Боковой элемент
с 2 сиденьями/侧位组件 2 人位
2 cuscini inclusi
2 pillows included
2 подушки в комплекте
含 2 个抱枕

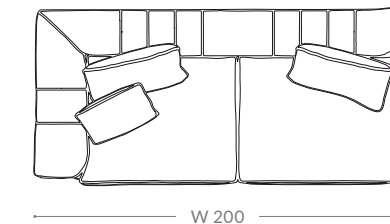
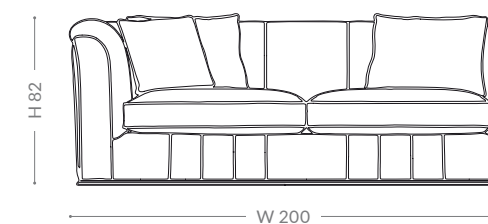

GORDON Elemento laterale 3 posti/
Side element 3 seats/Боковой элемент
с 3 сиденьями/侧位组件 3 人位
3 cuscini inclusi
3 pillows included
3 подушки в комплекте
含 3 个抱枕

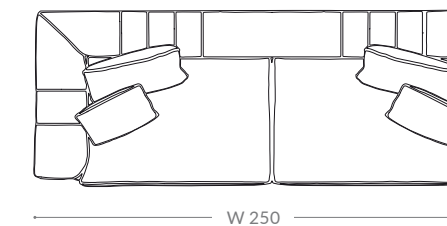
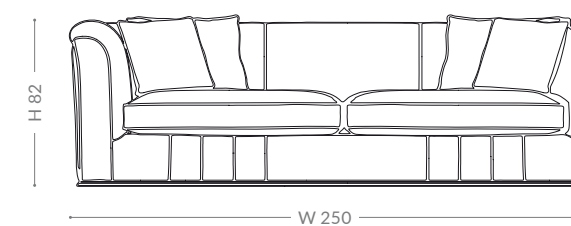

GORDON Elemento laterale 4 posti/
Side element 4 seats/Боковой элемент
с 4 сиденьями/侧位组件 4 人位
4 cuscini inclusi
4 pillows included
4 подушки в комплекте
含 4 个抱枕

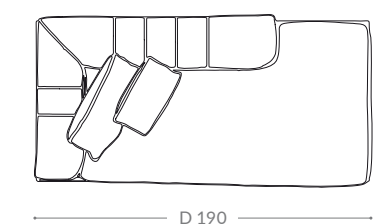
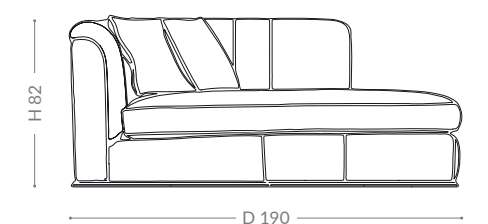

GORDON Dormeuse/Dormeuse/
Кухетка/沙发躺椅
2 cuscini inclusi
2 pillows included
2 подушки в комплекте
含 2 个抱枕

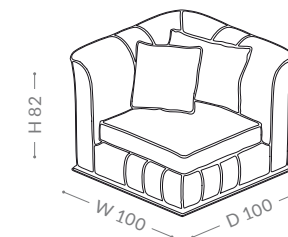

GORDON Elemento d'angolo/
Corner element/Угловой элемент/转角组件
2 cuscini inclusi
2 pillows included
2 подушки в комплекте
含 2 个抱枕

HARMONY

SOFA



S O F A S

As picture: Harmony 3 seats
In price list: Prestige/Brilliant

Divano/Sofa/Диван/沙发
BZ 216-120 VELVET RHUBARB

Cuscini/Pillows/Подушки/抱枕
BZ 210-02 PLUM FLOWER

Lucidatura/Finishing/Отделка/饰面
57. CHOCOLATE
69. CANALETTO WALNUT

Struttura in legno massello;
basamento in noce canaletto.
Cuscini seduta e schienale
in poliuretano a quote
differenziate. Meccanismo per
divano letto non disponibile.

Solid wood frame; canaletto
walnut wooden base. Multiple
densities polyurethane foam
seating and backrest. Bed
mechanism not available.

Каркас из массива дерева,
деревянная основа из ореха
каналетто. Пенополиуретан
разной плотности. Механизм
трансформации отсутствует.

实木框架；卡纳莱托胡桃木底
座。多重密度聚氨酯泡沫。不
可用作沙发床。

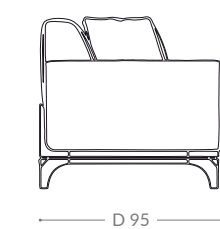
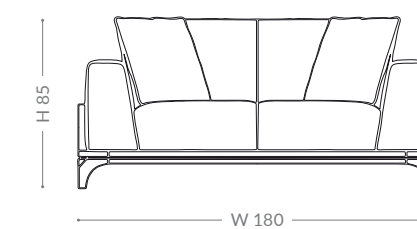

HARMONY 2 Posti/Seats/Сиденья/
座位
2 cuscini inclusi
2 pillows included
2 подушки в комплекте
含 2 个抱枕

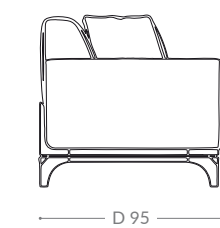
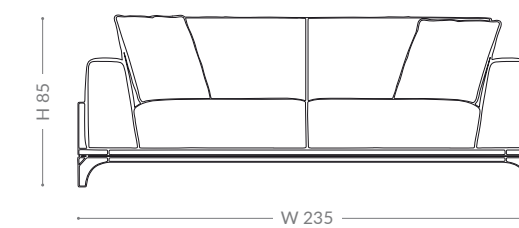

HARMONY 3 Posti/Seats/Сиденья/
座位
2 cuscini inclusi
2 pillows included
2 подушки в комплекте
含 2 个抱枕

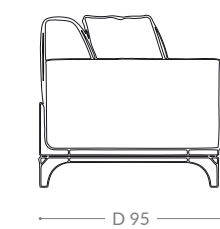
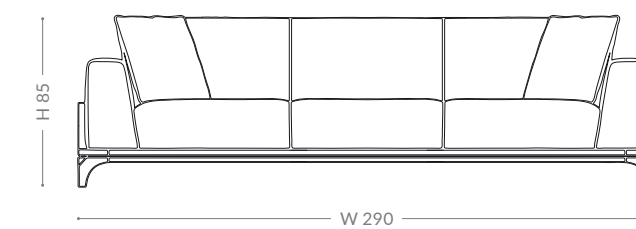

HARMONY 4 Posti/Seats/Сиденья/
座位
2 cuscini inclusi
2 pillows included
2 подушки в комплекте
含 2 个抱枕

HEMINGWAY

SOFA



Struttura in legno massello; piedini in legno di faggio. Seduta e schienale in poliuretano a quote differenziate. Meccanismo per divano letto non disponibile.

Solid wood frame; beechwood feet. Multiple densities polyurethane foam seating and backrest. Bed mechanism not available.

Каркас из массива дерева, ножки из бука. Пенополиуретан разной плотности. Механизм трансформации отсутствует.

实木框架；山毛榉沙发脚。多重密度聚氨酯泡沫。不可用作沙发床。

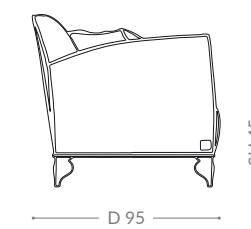
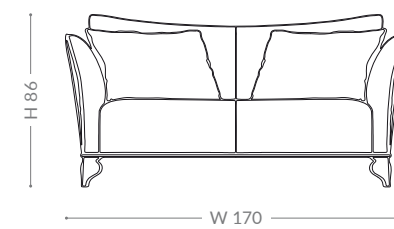

HEMINGWAY 2 Posti/Seats/
Сиденья/座位
2 cuscini inclusi
2 pillows included
2 подушки в комплекте
含 2 个抱枕

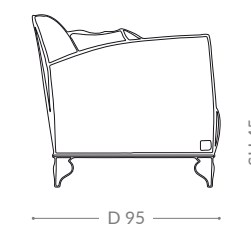
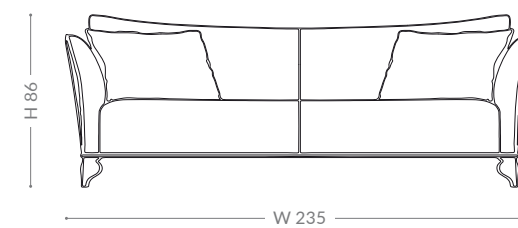

HEMINGWAY 3 Posti/Seats/
Сиденья/座位
2 cuscini inclusi
2 pillows included
2 подушки в комплекте
含 2 个抱枕

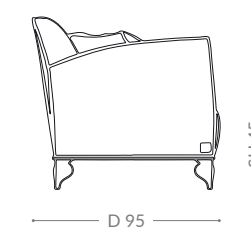
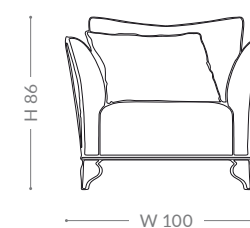

HEMINGWAY Poltrona/Armchair/
Кресло/扶手沙发椅
1 cuscino incluso
1 pillow included
1 подушка в комплекте
含 1 个抱枕

S O F A S

As picture: Hemingway 3 seats
In price list: Ambition/Brilliant

Divano/Sofa/Диван/沙发
BZ 901-702 LEATHER DOVE GREY

Cuscini/Pillows/Подушки/抱枕
BZ 206-09 BOUCLÉ PEBBLE

Lucidatura/Finishing/Отделка/饰面
54. GREY

IPAZIA

SOFA



Struttura in legno massello; basamento in legno di faggio. Cuscini di seduta e schienale in poliuretano a quote differenziate. Parte esterna e poggiatesta ricamati. Meccanismo per divano letto non disponibile.

Solid wood frame; beechwood base. Multiple densities polyurethane foam seating and backrest. Quilted outer body and headrest. Bed mechanism not available.

Каркас из массива дерева, основа из бука. Сиденье и спинка наполнены пенополиуретаном разной плотности. Стеганый внешняя часть и подголовник. Механизм трансформации отсутствует.

实木框架；山毛榉底座。座位和靠背填充多重密度聚氨酯泡沫。绗缝外部和头枕。床机制不可用。



S O F A S

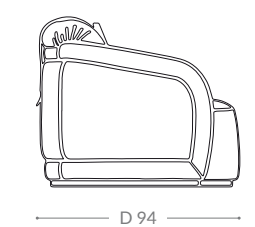
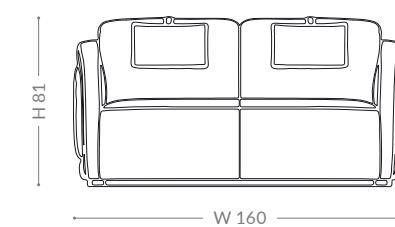

IPAZIA 2 Posti/Seats/Сиденья/座位
0 cuscini inclusi
0 pillows included
0 подушки в комплекте
含 0 个抱枕

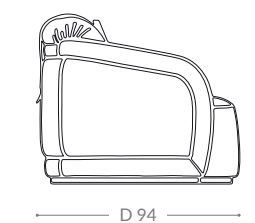
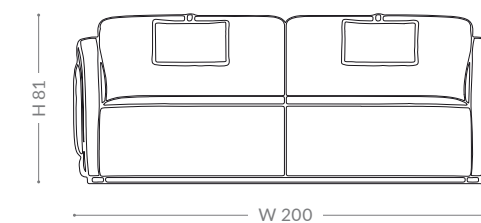

IPAZIA 3 Posti/Seats/Сиденья/座位
0 cuscini inclusi
0 pillows included
0 подушки в комплекте
含 0 个抱枕

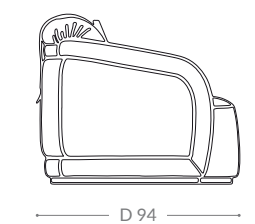
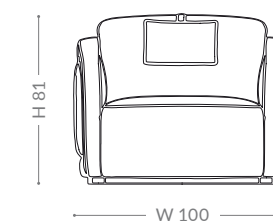

IPAZIA Poltrona/Armchair/Кресло/扶手沙发椅
0 cuscini inclusi
0 pillows included
0 подушки в комплекте
含 0 个抱枕

As picture: Ipaż a 3 seats
In price list: Prestige/Brilliant

Divano/Sofa/Диван/沙发
BZ 126-51 UNITO GREY/PEARL
BZ 901-702 LEATHER DOVE GREY

Lucidatura/Finishing/Отделка/饰面
54. GREY

Parti in metallo/Metal parts/Металлическая фурнитура/金属部件
TITANIUM

KING

SOFA



Struttura in legno massello; piedini in ottone. Parte interna trapuntata a quadrati e bottoni. Cuscini di seduta in vera piuma con inserto in poliuretano. Meccanismo per divano letto non disponibile.

Solid wood frame; brass feet. Quilted inner body with buttons. Seat cushions in natural feather with polyurethane insert. Bed mechanism not available.

Каркас из массива дерева, ножки из латуни. Стеганая внутренняя часть корпуса с пуговицами. Подушки сиденья наполнены натуральным пером и имеют полиуретановую прокладку. Механизм трансформации отсутствует.

实木框架；黄铜沙发脚。绗缝内侧部分（带纽扣）。坐垫填充天然羽毛和聚氨酯泡沫。不可用作沙发床。



S O F A S

As picture: King 3 seats
In price list: Prestige

Divano/Sofa/Диван/沙发
BZ 220-02 VELVET IVORY

Cuscini/Pillows/Подушки/抱枕
BZ 132-004 BOUCLÉ IVORY/GOLD
BZ 135-004 VELVET GALUCHAT GOLD

Parti in metallo/Metal parts/Металлическая фурнитура/金属部件
GOLD

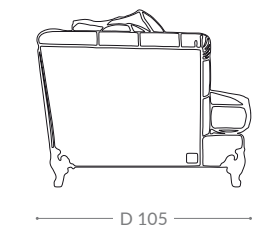
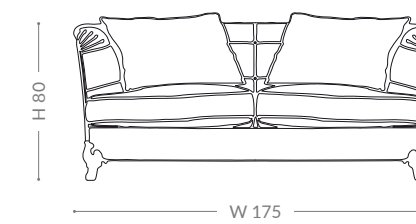

KING 2 Posti/Seats/Сиденья/座位
2 cuscini inclusi
2 pillows included
2 подушки в комплекте
含 2 个抱枕

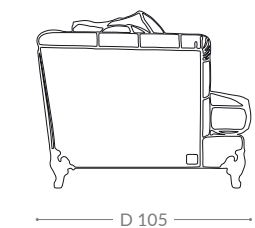
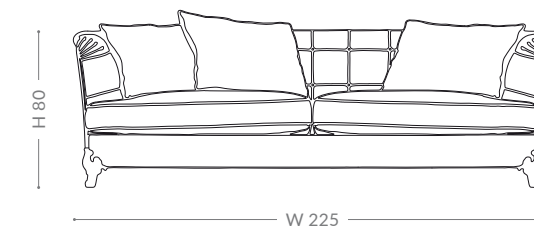

KING 3 Posti/Seats/Сиденья/座位
3 cuscini inclusi
3 pillows included
3 подушки в комплекте
含 3 个抱枕

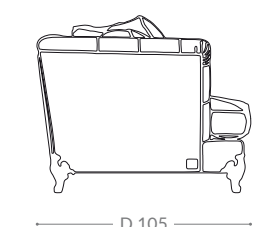
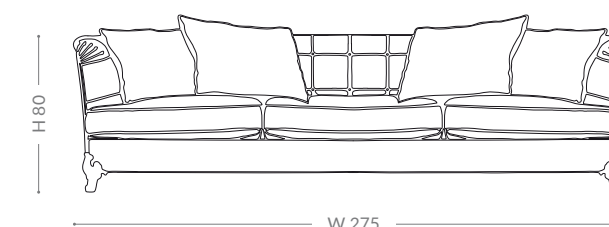

KING 4 Posti/Seats/Сиденья/座位
4 cuscini inclusi
4 pillows included
4 подушки в комплекте
含 4 个抱枕

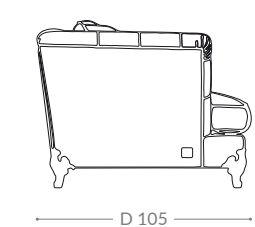
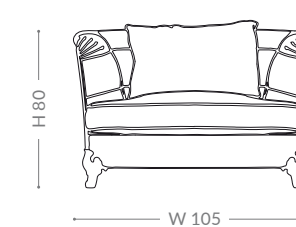

KING Poltrona/Armchair/Кресло/扶手沙发椅
1 cuscino incluso
1 pillow included
1 подушка в комплекте
含 1 个抱枕

LEGEND

SOFA



Struttura in legno massello. Gambe frontali in legno di faggio con decorazioni in ottone. Parte interna ricamata; schienale con decorazione a corsetto. Cuscini di seduta in vera piuma con inserto in poliuretano. Meccanismo per divano letto non disponibile.

Solid wood frame. Beechwood front legs with brass decoration. Quilted backrest; outer body with corset decoration. Seat cushions in natural feather with polyurethane insert. Bed mechanism not available.

Каркас из массива дерева. Передние ножки из бука украшены элементами из латуни. Стеганая спинка, внешняя часть корпуса с корсетной отделкой. Подушки сиденья наполнены натуральным пером и имеют полиуретановую прокладку. Механизм трансформации отсутствует.

实木框架。山毛榉沙发脚（前脚）采用黄铜装饰。绗缝靠背；外侧部分采用交叉系绳装饰。坐垫填充天然羽毛和聚氨酯泡沫。不可用作沙发床。



S O F A S

As picture: Legend 3 seats
In price list: Prime/Brilliant

Divano/Sofa/Диван/沙发
BZ 901-332 LEATHER BUTTER
BZ 156-417 VELVET IVORY

Cuscini/Pillows/Подушки/抱枕
BZ 126-52 UNITO IVORY
Lucidatura/Finishing/Отделка/饰面
50. IVORY

Parti in metallo/Metal parts/Металлическая фурнитура/金属部件
GOLD

LEGEND

SOFA



S O F A S

As picture: Legend 3 seats
In price list: Ambition/Brilliant

Divano/Sofa/Диван/沙发
BZ 901-632 LEATHER LIGHT BROWN

Cuscini/Pillows/Подушки/抱枕
BZ 188-07 BOUCLÉ SAND
Lucidatura/Finishing/Отделка/饰面
55. COFFEE

Parti in metallo/Metal parts/Металлическая фурнитура/金属部件
TITANIUM

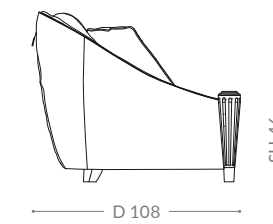
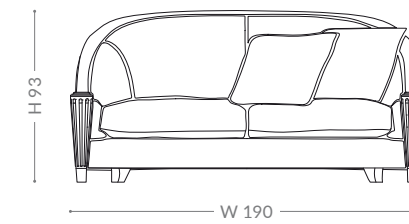

LEGEND 2 Posti/Seats/Сиденья/座位
2 cuscini inclusi
2 pillows included
2 подушки в комплекте
含 2 个抱枕

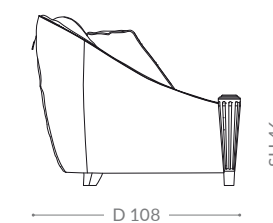
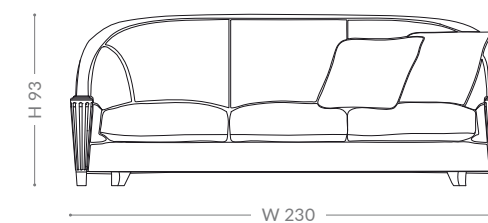

LEGEND 3 Posti/Seats/Сиденья/座位
2 cuscini inclusi
2 pillows included
2 подушки в комплекте
含 2 个抱枕

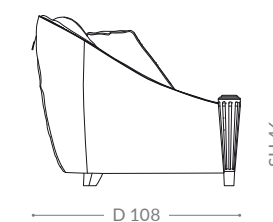
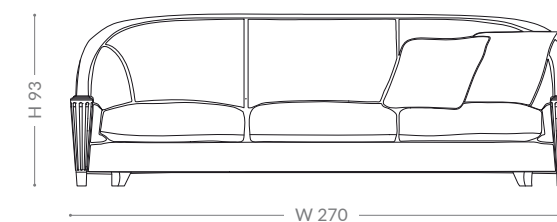

LEGEND 4 Posti/Seats/Сиденья/座位
2 cuscini inclusi
2 pillows included
2 подушки в комплекте
含 2 个抱枕

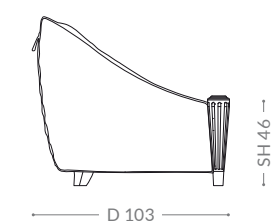
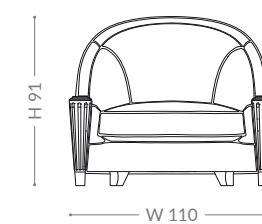

LEGEND Poltrona/Armchair/
Кресло/扶手沙发椅
0 cuscini inclusi
0 pillows included
0 подушки в комплекте
含 0 个抱枕

POSEIDON

SOFA



Struttura in legno massello; basamento in legno di faggio. Parte esterna ricamata. Cuscini di seduta e schienale in poliuretano a quote differenziate. Meccanismo per divano letto non disponibile.

Solid wood frame; beechwood base. Quilted outer body. Multiple densities polyurethane foam. Bed mechanism not available.

Каркас из массива дерева, основа из бука. Стеганая внешняя часть корпуса. Пенополиуретан разной плотности. Механизм трансформации отсутствует.

实木框架；山毛榉底座。外侧部分绗缝。多重密度聚氨酯泡沫。不可用作沙发床。



Parti in metallo/Metal parts/Металлическая фурнитура/金属部件
GOLD

As picture: Poseidon 4 seats
In price list: Prime/Brilliant

Divano/Sofa/Диван/沙发
BZ 187-127 VELVET SAND
BZ 901-891 LEATHER IVORY

Cuscini/Pillows/Подушки/抱枕
BZ 901-891 LEATHER IVORY
BZ 184-901 PALMA BEIGE/IVORY

Lucidatura/Finishing/Отделка/饰面
51. SAND

POSEIDON

SOFA



S O F A S

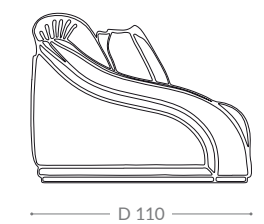
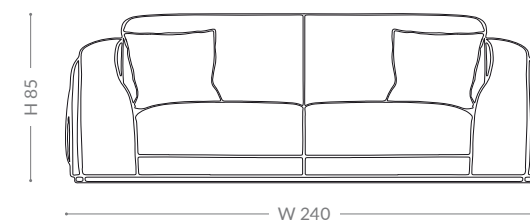

POSEIDON 3 Posti/Seats/Сиденья/
座位
2 cuscini inclusi
2 pillows included
2 подушки в комплекте
含 2 个抱枕

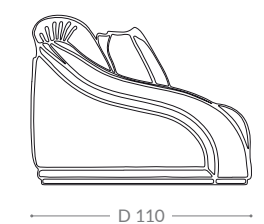
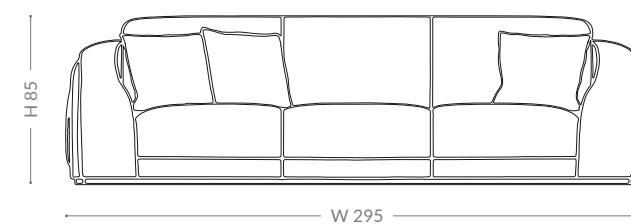

POSEIDON 4 Posti/Seats/Сиденья/
座位
3 cuscini inclusi
3 pillows included
3 подушки в комплекте
含 3 个抱枕

As picture: Poseidon 4 seats
In price list: Exclusive

Divano/Sofa/Диван/沙发
BZ 203-009 BOUCLÉ BLUE
BZ 905-5049 LEATHER DARK BLUE

Cuscini/Pillows/Подушки/抱枕
BZ 200-802 VELVET BLUE
Lucidatura/Finishing/Отделка/饰面
85. CHOCOLATE MATT

Parti in metallo/Metal parts/Метал-
лическая фурнитура/金属部件
TITANIUM

VERTIGO

SOFA



Struttura in legno massello. Cornici in legno di noce canaletto. Schienale trapuntato. Cuscini di seduta in vera piuma con inserto in poliuretano. Braccioli esterni in pelle ricamata o con mosaico su richiesta. Meccanismo per divano letto non disponibile.

Solid wood structure; canaletto walnut wooden frames. Quilted backrest. Seat cushions in natural feather with polyurethane insert. External armrests in quilted leather (alternatively with mosaic on request). Bed mechanism not available.

Конструкция из массива дерева, деревянные каркасы из ореха каналетто. Стеганая спинка. Подушки сиденья наполнены натуральным пером и имеют полиуретановую прокладку. Внешняя часть подлокотников выполнена из стеганой кожи (украшение из мозаики выполняется по заказу). Механизм трансформации отсутствует.

实木结构；卡纳莱托胡桃木框架。绗缝靠背。坐垫填充天然羽毛和聚氨酯泡沫。扶手外侧为绗缝皮革（也可根据要求镶嵌图案）。不可用作沙发床。



S O F A S

As picture: Vertigo 4 seats
In price list: Ambition/Brilliant/
Twin mosaic on request

Divano/Sofa/Диван/沙发
BZ 906-2006 LEATHER TAUPE
MOSAIC DECORATION

Cuscini/Pillows/Подушки/抱枕
BZ 203-004 BOUCLÉ TIFFANY

Lucidatura/Finishing/Отделка/饰面
69. CANALETTO WALNUT

VERTIGO

SOFA



S O F A S

As picture: Vertigo 3 seats
In price list: Ambition/Brilliant

Divano/Sofa/Диван/沙发
BZ 906-2005 LEATHER OASI

Cuscini/Pillows/Подушки/抱枕
BZ 218-206 VELVET CARVED BROWN

Lucidatura/Finishing/Отделка/饰面
69. CANALETTO WALNUT

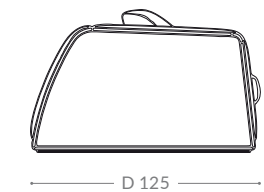
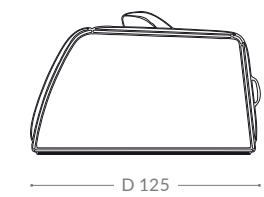
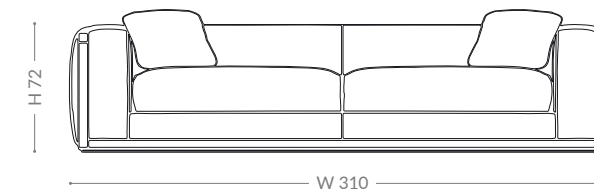
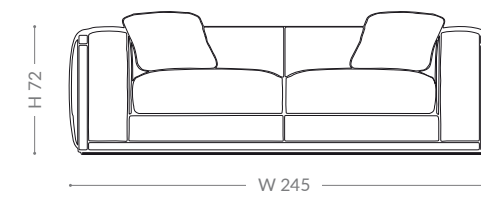

VERTIGO 3 Posti/Seats/Сиденья/座位
2 cuscini inclusi
2 pillows included
2 подушки в комплекте
含 2 个抱枕

VERTIGO 4 Posti/Seats/Сиденья/座位
2 cuscini inclusi
2 pillows included
2 подушки в комплекте
含 2 个抱枕

WAVE

SOFA



Struttura in legno massello. Piedini e anello braccioli in metallo oro martellato. Esterno braccioli in pelle ricamata. Cuscini di seduta e schienale in vera piuma con inserto in poliuretano. Meccanismo per divano letto non disponibile.

Solid wood frame. Feet and armrests decoration in hammered gold metal. Leather decoration on outer armrests. Seat and back cushions in natural feather with polyurethane insert. Bed mechanism not available.

Каркас из массива дерева. Ножки и подлокотники украшены чеканным золотистым металлом. Кожаная отделка внешней части подлокотников. Подушки сиденья и спинки наполнены натуральным пером и имеют полиуретановую прокладку. Механизм трансформации отсутствует.

实木框架。沙发脚和扶手采用金色锻造金属装饰。扶手外侧采用皮革装饰。坐垫和靠背填充天然羽毛和聚氨酯泡沫。不可用作沙发床。



S O F A S

As picture: Wave 3 seats
In price list: Ambition

Divano/Sofa/Диван/沙发
BZ 905-5230 LEATHER GREY

Cuscini/Pillows/Подушки/抱枕
BZ 192-003 CHEVRON GREY

Parti in metallo/Metal parts/Металлическая фурнитура/金属部件
HAMMERED GOLD

WAVE
SOFA

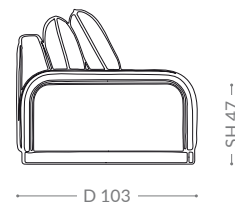
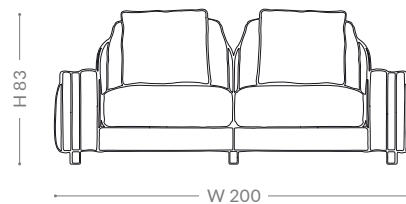
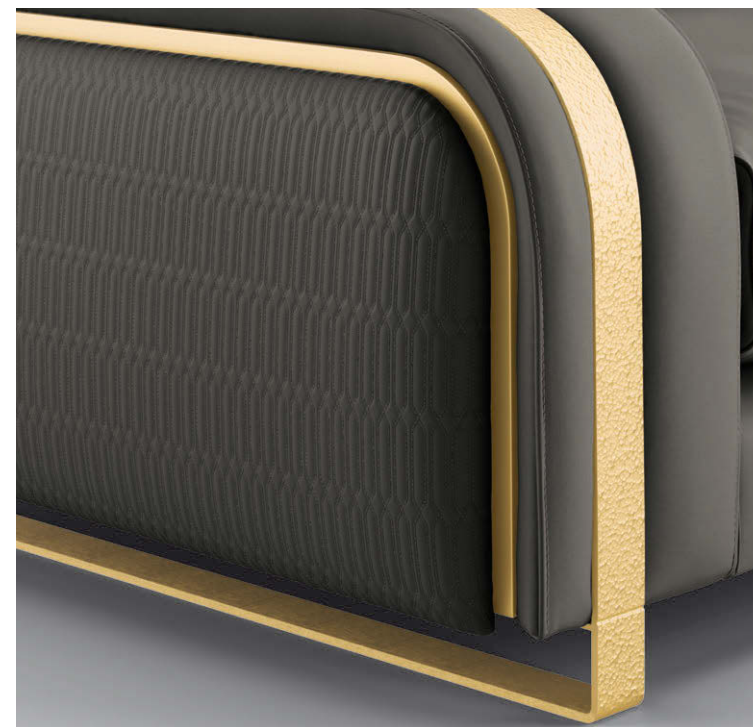

WAVE 2 Posti/Seats/Сиденья/座位
2 cuscini inclusi
2 pillows included
2 подушки в комплекте
含 2 个抱枕

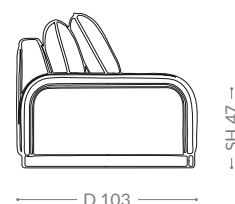
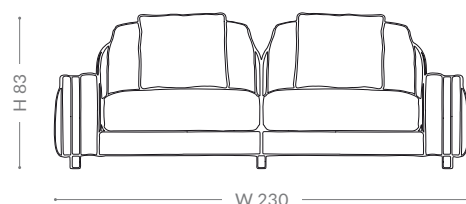

WAVE 2,5 Posti/Seats/Сиденья/座位
2 cuscini inclusi
2 pillows included
2 подушки в комплекте
含 2 个抱枕

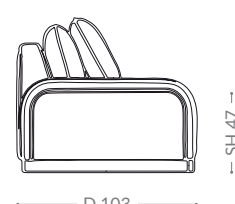
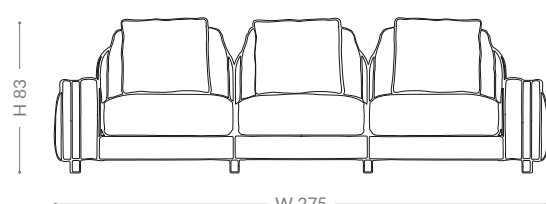

WAVE 3 Posti/Seats/Сиденья/座位
3 cuscini inclusi
3 pillows included
3 подушки в комплекте
含 3 个抱枕

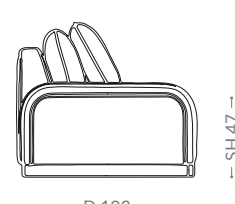
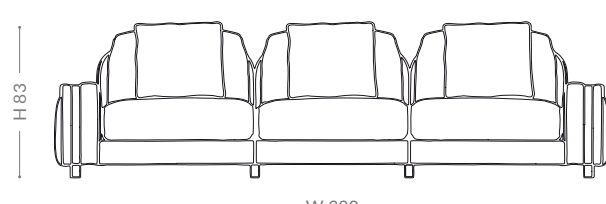

WAVE 4 Posti/Seats/Сиденья/座位
3 cuscini inclusi
3 pillows included
3 подушки в комплекте
含 3 个抱枕

WAVE
MODULAR SOFA



As picture: Wave modular (2 side elements with arm cm 100 + 4 single elements cm 75 + corner table)
In price list: Prime

Divano/Sofa/Диван/沙发
BZ 206-11 BOUCLÉ SANDSTONE
BZ 906-2023 LEATHER CARAMEL

Cuscini/Pillows/Подушки/抱枕
BZ 208-0416 LEAF TAUPE
Lucidatura/Finishing/Отделка/饰面
93. WENGÉ MATT
100. GREY MATT

Parti in metallo/Metal parts/
Металлическая фурнитура/
金属部件
HAMMERED GOLD

Struttura in legno massello. Piedini e anello braccioli in metallo oro martellato. Esterno braccioli in pelle ricamata. Cuscini di seduta e schienale in vera piuma con inserto in poliuretano. Meccanismo per divano letto non disponibile.

Solid wood frame. Feet and armrests decoration in hammered gold metal. Leather decoration on outer armrests. Seat and back cushions in natural feather with polyurethane insert. Bed mechanism not available.

Каркас из массива дерева. Ножки и подлокотники украшены чеканным золотистым металлом. Кожаная отделка внешней части подлокотников. Подушки сиденья и спинки наполнены натуральным пером и имеют полиуретановую прокладку. Механизм трансформации отсутствует.

实木框架。沙发脚和扶手采用金色锻造金属装饰。扶手外侧采用皮革装饰。坐垫和靠背填充天然羽毛和聚氨酯泡沫。不可用作沙发床。



WAVE
MODULAR SOFA

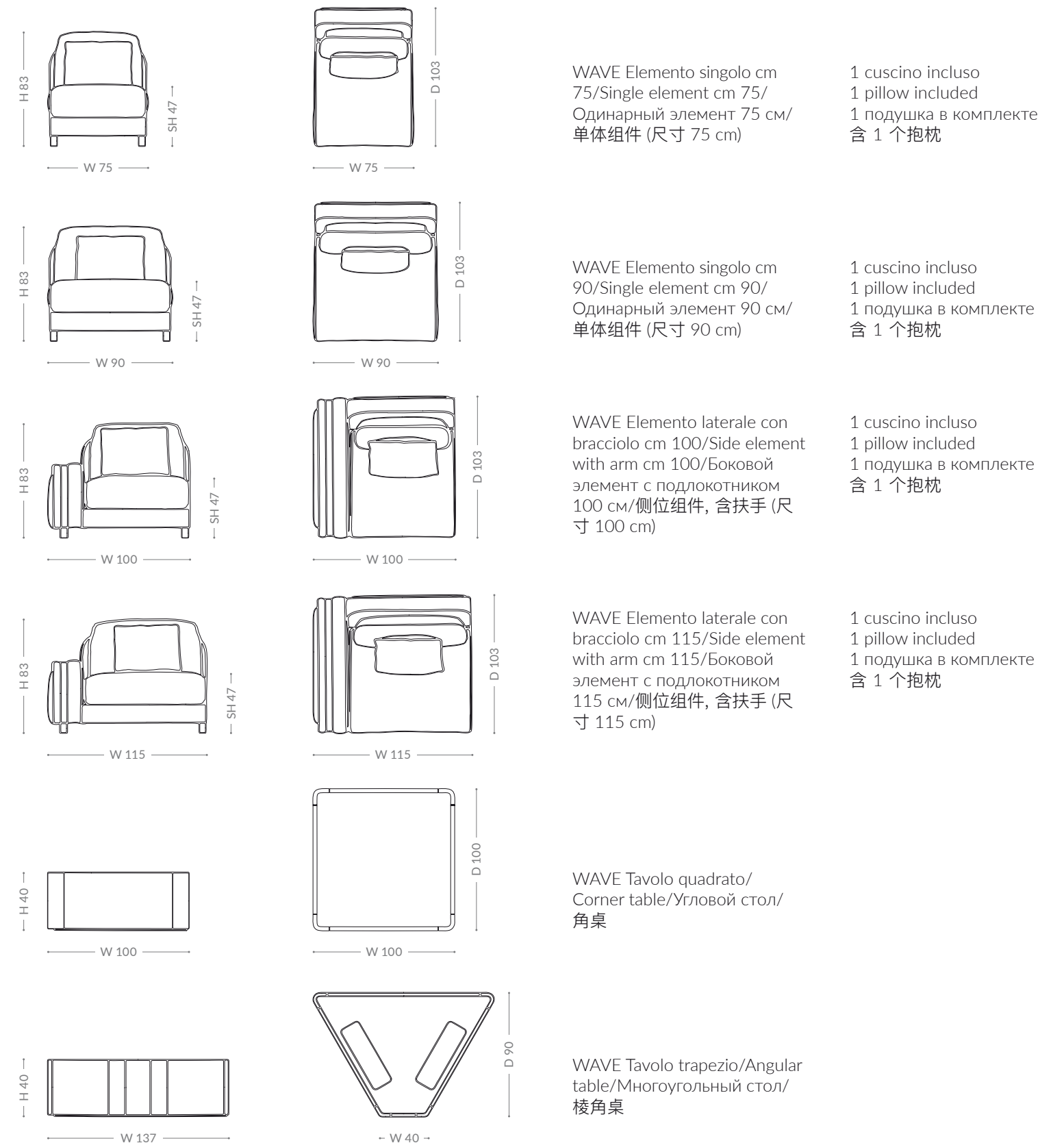

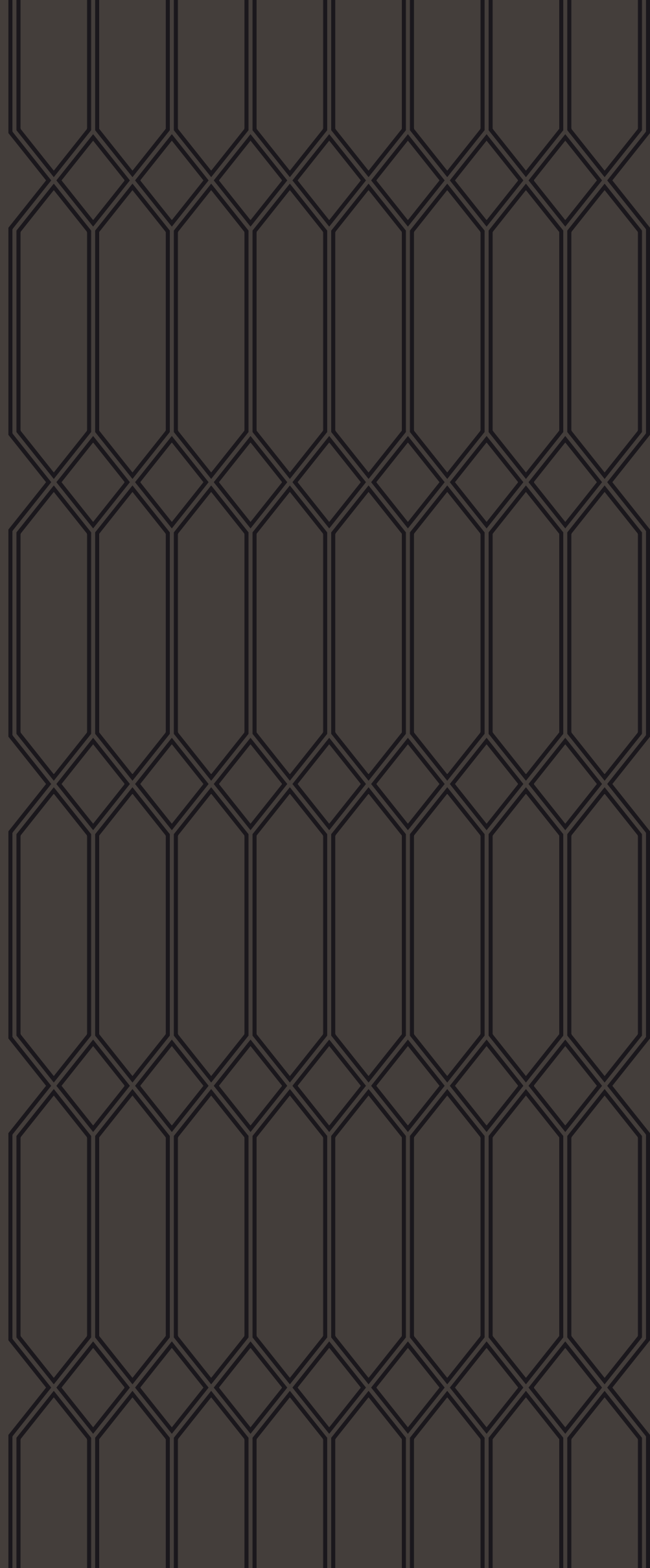

ZB

ARMCHAIRS



ARDEA

ARMCHAIR

Struttura in multistrati di legno sagomato; telaio in metallo. Parte esterna ricamata. Seduta in poliuretano a quote differenziate.

Plywood shaped structure; metal frame. Quilted outer body. Multiple densities polyurethane foam seating.

Фигурная конструкция из фанеры, металлический каркас. Стеганая внешняя часть корпуса. Сиденье наполнено пенополиуретаном разной плотности.

胶合板型材结构；金属框架。外侧部分绗缝。座位填充多重密度聚氨酯泡沫。



As picture: Ardea armchair
In price list: Ambition

Poltrona/Armchair/Кресло/扶手沙发椅
BZ 906-2030 LEATHER BURGUNDY

Lucidatura/Finishing/Отделка/饰面
GOLD

ARDEA

ARMCHAIR



ARMCHAIRS

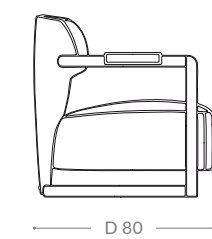
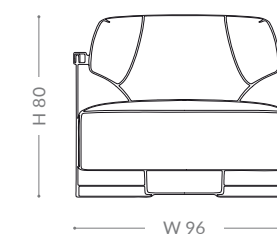

As picture: Ardea armchair
In price list: Exclusive

Poltrona/Armchair/Кресло/扶手沙发椅
BZ 218-206 VELVET CARVED BROWN
BZ 906-2003 LEATHER DARK BROWN

Lucidatura/Finishing/Отделка/饰面
TITANIUM

ARIEL

ARMCHAIR



Struttura in legno massello.
Piedini in noce canaletto.
Schienale e parte esterna con
ricamo. Cuscino di seduta in
vera piuma con inserto in
poliuretano.

Solid wood frame. Canaletto
walnut wooden feet. Quilted
backrest and outer body. Seat
cushions in natural feather
with polyurethane insert.

Каркас из массива дерева.
Деревянные ножки из ореха
каналетто. Стеганные спинка
и внешняя часть корпуса.
Подушки сиденья наполнены
натуральным пером и имеют
полиуретановую прокладку.

实木框架。卡纳莱托胡桃木沙
发脚。绗缝靠背和外侧部分。
坐垫填充天然羽毛和聚氨酯泡
沫。

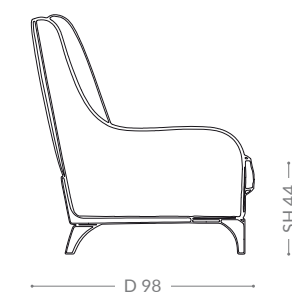
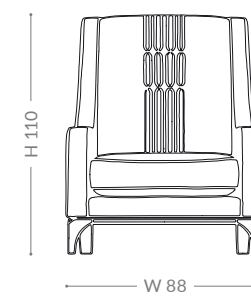

As picture: Ariel armchair
In price list: Exclusive/Brilliant

Poltrona/Armchair/Кресло/扶手沙发椅
BZ 203-004 BOUCLÉ TIFFANY
BZ 906-2006 LEATHER TAUPE

Lucidatura/Finishing/Отделка/饰面
70. CANALETTO WALNUT MATT
54. GREY

AURORA

ARMCHAIR



Struttura in legno massello; finitura con borchie in pelle. Cuscino di seduta in vera piuma con inserto in poliuretano.

Solid wood frame; finished with leather covered nails. Seat cushions in natural feather with polyurethane insert.

Каркас из массива дерева, отделка из декоративных гвоздей с кожаной шляпкой. Подушки сиденья наполнены натуральным пером и имеют полиуретановую прокладку.

实木框架；采用皮革镶钉装饰。坐垫填充天然羽毛和聚氨酯泡沫。

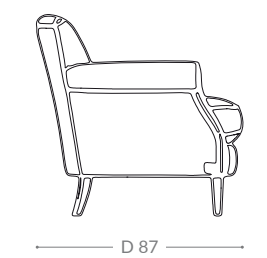
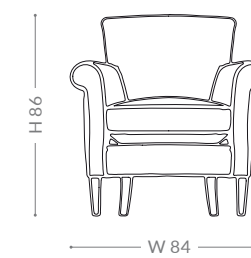

ARMCHAIRS

As picture: Aurora armchair
In price list: Ambition/Brilliant

Poltrona/Armchair/Кресло/扶手沙发椅
BZ 901-965 LEATHER BLACK

Lucidatura/Finishing/Отделка/饰面
58. BLACK

Parti in metallo/Metal parts/Металлическая фурнитура/金属部件
TITANIUM

BAUHAUS

ARMCHAIR



Struttura in legno massello. Schienale esterno in listellare/MDF con lavorazione verticale e decorazione in legno applicata sul perimetro. Schienale trapuntato a rombi con bottoni. Cuscini di seduta in vera piuma con inserto in poliuretano.

Solid wood frame. Outer body in blockboard/MDF with fluted decoration. Wooden elements applied on the edge. Quilted backrest with buttons. Seat cushions in natural feather with polyurethane insert.

Каркас из массива дерева. Внешняя часть корпуса выполнена из столлярной плиты/МДФ с рельефной отделкой. Края украшены деревянными элементами. Стеганая спинка с пуговицами. Подушки сиденья наполнены натуральным пером и имеют полиуретановую прокладку.

实木框架。外侧部分为带凹槽装饰的细木工板/中密度纤维板。沙发边缘镶嵌木制组件。绗缝靠背（带纽扣）。坐垫填充天然羽毛和聚氨酯泡沫。

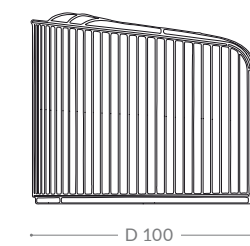
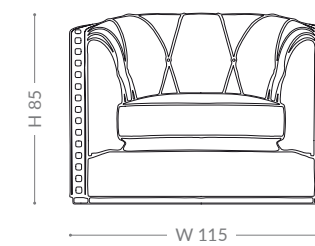

As picture: Bauhaus armchair
In price list: Prestige/Brilliant

Poltrona/Armchair/Кресло/扶手沙发椅
BZ 126-51 UNITO GREY/PEARL

Lucidatura/Finishing/Отделка/饰面
53. DOVE GREY

BEVERLY

ARMCHAIR



Struttura in legno massello e multistrati di faggio; basamento in metallo. Inserto ricamato su schiena e seduta. Cuscini in poliuretano a quote differenziate.

Solid wood frame; plywood beechwood. Metal base. Quilted backrest and seating. Multiple densities polyurethane foam cushions.

Каркас из массива дерева, фанера из бука. Металлическая основа. Стеганные спинка и сиденье. Пенополиуретан разной плотности.

实木框架；山毛榉胶合板。金属底座。绗缝靠背和座位。多重密度聚氨酯泡沫。



As picture: Beverly armchair
In price list: Ambition

Poltrona/Armchair/Кресло/扶手沙发椅
BZ 901-891 LEATHER IVORY

Parti in metallo/Metal parts/Металлическая фурнитура/金属部件
TITANIUM

BEVERLY

ARMCHAIR



ARMCHAIRS

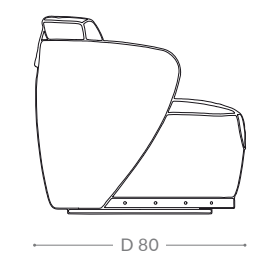
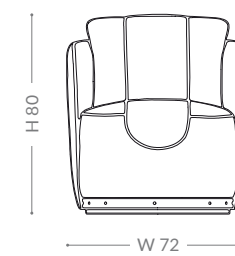

As picture: Beverly armchair
In price list: Ambition

Poltrona/Armchair/Кресло/扶手沙发椅
BZ 905-5103 LEATHER LOBSTER

Parti in metallo/Metal parts/Метал-
лическая фурнитура/金属部件
GOLD

CLUB

ARMCHAIR



As picture: Club armchair
In price list: Supreme/Brilliant

Poltrona/Armchair/Кресло/扶手沙发椅
BZ 902-N8409 NABUK LIGHT BROWN

Lucidatura/Finishing/Отделка/饰面
57. CHOCOLATE

Struttura in legno massello. Piedini in legno intagliati a mano; parte esterna in legno multistrati decorata con traforo. Cuscini di seduta e schienale in poliuretano a quote differenziate.

Solid wood frame. Hand-carved wooden feet; fretwork plywood outer frame. Multiple densities polyurethane foam seating and backrest.

Каркас из массива дерева. Деревянные ножки ручной работы, наружный резной каркас из фанеры. Сиденье и спинка наполнены пенополиуретаном разной плотности.

实木框架。木制沙发脚采用手工雕刻；外框采用浮雕胶合板。座位和靠背填充多重密度聚氨酯泡沫。

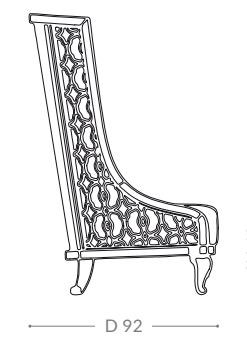
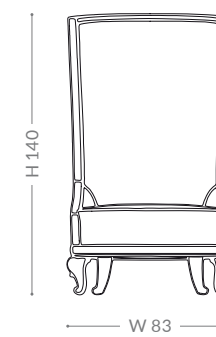

CLUB WIDE

ARMCHAIR



Struttura in legno massello. Piedini in legno intagliati a mano; parte esterna in legno multistrati decorata con traforo. Cuscini di seduta e schienale in vera piuma con inserto in poliuretano.

Solid wood frame. Hand-carved wooden feet; fretwork plywood outer frame. Seat and back cushions in natural feather with polyurethane insert.

Каркас из массива дерева. Деревянные ножки ручной работы, наружный резной каркас из фанеры. Подушки сиденья и спинки наполнены натуральным пером и имеют полиуретановую прокладку.

实木框架；木制底座。分块铆钉装饰（靠背和扶手）。坐垫填充天然羽毛和聚氨酯泡沫。

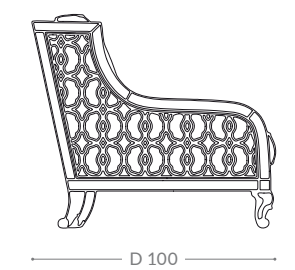
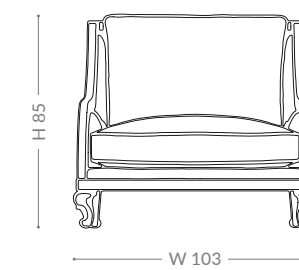

As picture: Club Wide armchair
In price list: Prime/Brilliant

Poltrona/Armchair/Кресло/扶手沙发椅
BZ 206-09 BOUCLÉ PEBBLE
BZ 901-702 LEATHER DOVE GREY

Lucidatura/Finishing/Отделка/饰面
54. GREY

DAVIS

ARMCHAIR

Struttura in legno massello; basamento in legno di faggio. Schienale e braccioli capitonné. Cuscini di seduta in vera piuma con inserto in poliuretano.

Solid wood frame; wooden base. Capitonné backrest and armrests. Seat cushions in natural feather with polyurethane insert.

Каркас из массива дерева, деревянная основа. Спинка и подлокотники с обивкой в виде каретной стяжки. Подушки сиденья наполнены натуральным пером и имеют полиуретановую прокладку.

实木框架；木制底座。分块铆钉装饰（靠背和扶手）。坐垫填充天然羽毛和聚氨酯泡沫。



ARMCHAIRS

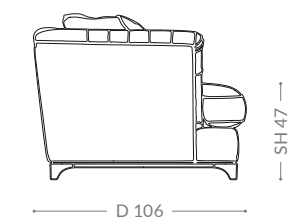
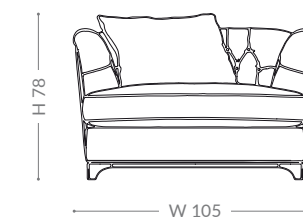

1 cuscino incluso
1 pillow included
1 подушка в комплекте
含 1 个抱枕

As picture: Davis armchair
In price list: Ambition/Brilliant

Poltrona/Armchair/Кресло/扶手沙发椅
BZ 901-965 LEATHER BLACK

Cuscini/Pillows/Подушки/抱枕
BZ 137-0678 BOUCLÉ BLACK/BEIGE

Lucidatura/Finishing/Отделка/饰面
58. BLACK

DAVIS SMALL

ARMCHAIR



Struttura in legno massello; basamento in legno di faggio. Schienale e braccioli capitonné. Cuscini di seduta in vera piuma con inserto in poliuretano.

Solid wood frame; wooden base. Capitonné backrest and armrests. Seat cushions in natural feather with polyurethane insert.

Каркас из массива дерева, деревянная основа. Спинка и подлокотники с обивкой в виде каретной стяжки. Подушки сиденья наполнены натуральным пером и имеют полиуретановую прокладку.

实木框架；木制底座。分块铆钉装饰（靠背和扶手）。坐垫填充天然羽毛和聚氨酯泡沫。

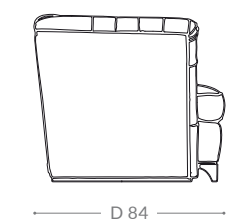
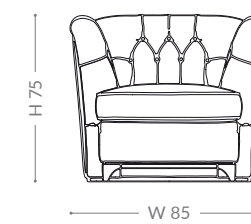

As picture: Davis Small armchair
In price list: Prime/Brilliant

Poltrona/Armchair/Кресло/扶手沙发椅
BZ 221-03 UNITO IVORY/CREAM

Lucidatura/Finishing/Отделка/饰面
51. SAND

FLOWER

ARMCHAIR



Struttura in legno massello; piedini in legno intagliati a mano. Cuscino di seduta in poliuretano a quote differenziate.

Solid wood frame. Hand-carved wooden feet. Multiple densities polyurethane foam seating.

Каркас из массива дерева. Деревянные ножки ручной работы. Сиденье наполнено пенополиуретаном разной плотности.

实木框架。手工雕刻木制沙发脚。座位填充多重密度聚氨酯泡沫。

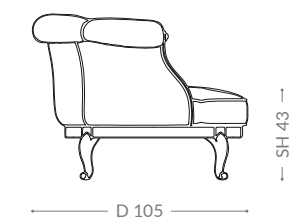
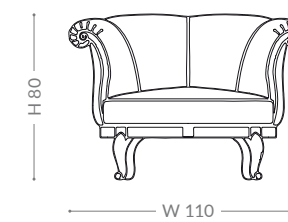

As picture: Flower armchair
In price list: Prime/Brilliant

Poltrona/Armchair/Кресло/扶手沙发椅
BZ 187-127 VELVET SAND

Lucidatura/Finishing/Отделка/饰面
57. CHOCOLATE

FLY
ARMCHAIR



Struttura in legno massello; basamento in legno di faggio sagomato. Cuscini di seduta in vera piuma con inserto in poliuretano.

Solid wood frame; shaped beechwood base. Seat cushions in natural feather with polyurethane insert.

Каркас из массива дерева, фигурная основа из бука. Подушки сиденья наполнены натуральным пером и имеют полиуретановую прокладку.

实木框架；山毛榉型材底座。坐垫填充天然羽毛和聚氨酯泡沫。

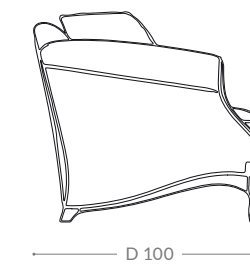
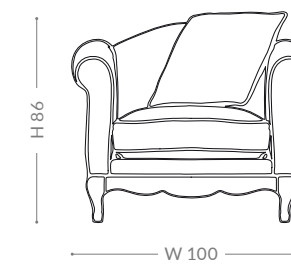

1 cuscino incluso
1 pillow included
1 подушка в комплекте
含 1 个抱枕

IPAZIA

ARMCHAIR

Struttura in legno massello; basamento in legno di faggio. Cuscini di seduta e schienale in poliuretano a quote differenziate. Parte esterna e poggiatesta ricamati.

Solid wood frame; beechwood base. Multiple densities polyurethane foam seating and backrest. Quilted outer body and headrest.

Каркас из массива дерева, основа из бука. Сиденье и спинка наполнены пенополиуретаном разной плотности. Стеганный внешняя часть и подголовник.

实木框架；山毛榉底座。座位和靠背填充多重密度聚氨酯泡沫。绗缝外部和头枕。



As picture: Ipaž a armchair
In price list: Prestige/Brilliant

Poltrona/Armchair/Кресло/扶手沙发椅
BZ 188-06 BOUCLÉ TEAL
BZ 901-632 LEATHER LIGHT BROWN

Lucidatura/Finishing/Отделка/饰面
55. COFFEE

Parti in metallo/Metal parts/Металлическая фурнитура/金属部件
TITANIUM

IPAZIA

ARMCHAIR

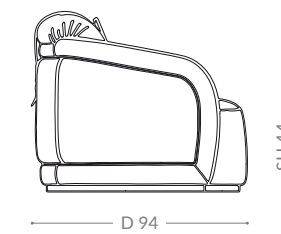
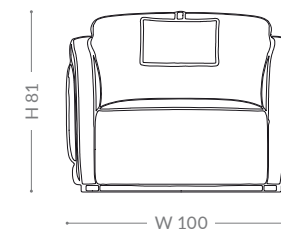

ARMCHAIRS

As picture: Ipaž a armchair
In price list: Prime

Poltrona/Armchair/Кресло/扶手沙发椅
BZ 206-11 BOUCLÉ SANDSTONE
BZ 906-2023 LEATHER CARAMEL

Lucidatura/Finishing/Отделка/饰面
100. GREY MATT

Parti in metallo/Metal parts/Металлическая фурнитура/金属部件
GOLD

KING

ARMCHAIR



Struttura in legno massello; piedini in ottone. Parte interna trapuntata a quadrati e bottoni. Cuscini di seduta in vera piuma con inserto in poliuretano.

Solid wood frame; brass feet. Quilted inner body with buttons. Seat cushions in natural feather with polyurethane insert.

Каркас из массива дерева, ножки из латуни. Стеганая внутренняя часть корпуса с пуговицами. Подушки сиденья наполнены натуральным пером и имеют полиуретановую прокладку.

实木框架；黄铜沙发脚。绗缝内侧部分（带纽扣）。坐垫填充天然羽毛和聚氨酯泡沫。



ARMCHAIRS

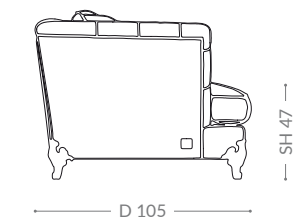
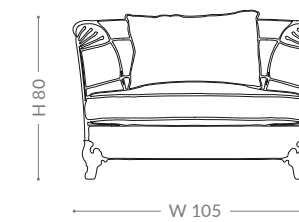

1 cuscino incluso
1 pillow included
1 подушка в комплекте
含 1 个抱枕

As picture: King armchair
In price list: Prestige

Poltrona/Armchair/Кресло/扶手沙发椅
BZ 220-06 VELVET CHOCOLATE

Cuscini/Pillows/Подушки/抱枕
BZ 221-15 UNITO CHOCOLATE

Parti in metallo/Metal parts/Металлическая фурнитура/金属部件
TITANIUM

LEGEND

ARMCHAIR



Struttura in legno massello. Gambe frontali in legno di faggio con decorazioni in ottone. Parte interna ricamata; schienale con decorazione a corsetto. Cuscini di seduta in vera piuma con inserto in poliuretano.

Solid wood frame. Beechwood front legs with brass decoration. Quilted backrest; outer body with corset decoration. Seat cushions in natural feather with polyurethane insert.

Каркас из массива дерева. Передние ножки из бука украшены элементами из латуни. Стеганая спинка, внешняя часть корпуса с корсетной отделкой. Подушки сиденья наполнены натуральным пером и имеют полиуретановую прокладку.

实木框架。山毛榉沙发脚（前脚）采用黄铜装饰。绗缝靠背；外侧部分采用交叉系绳装饰。坐垫填充天然羽毛和聚氨酯泡沫。

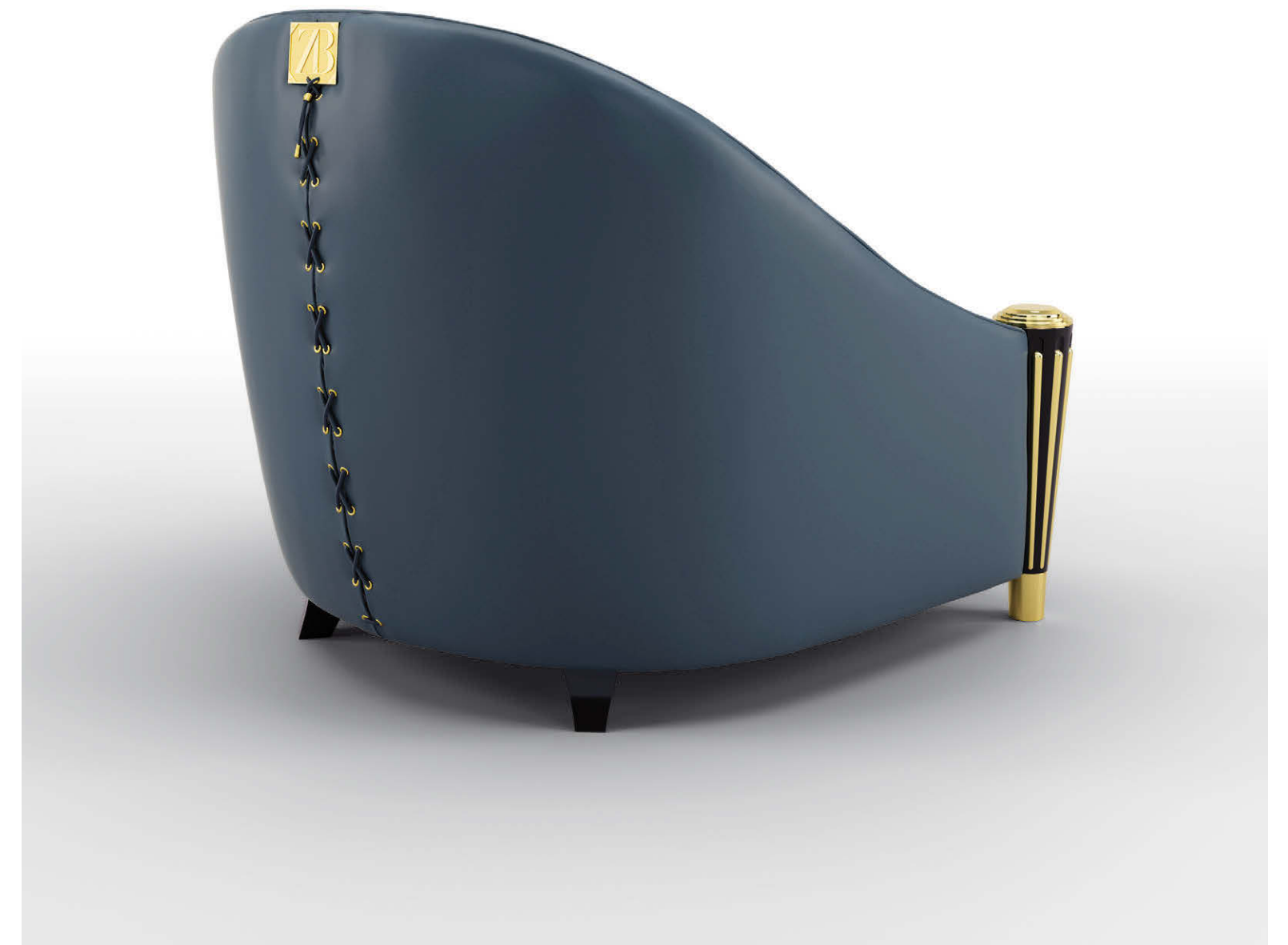

As picture: Legend armchair
In price list: Supreme/Brilliant

Poltrona/Armchair/Кресло/扶手沙发椅
BZ 901-501 LEATHER BLUE PRUSSIA
BZ 902 NABUK BLUE

Lucidatura/Finishing/Отделка/饰面
57. CHOCOLATE

Parti in metallo/Metal parts/Металлическая фурнитура/金属部件
GOLD

LEGEND

ARMCHAIR



ARMCHAIRS

As picture: Legend armchair
In price list: Ambition/Brilliant

Poltrona/Armchair/Кресло/扶手沙发椅
BZ 901-632 LEATHER LIGHT BROWN

Lucidatura/Finishing/Отделка/饰面
55. COFFEE

Parti in metallo/Metal parts/Металлическая фурнитура/金属部件
TITANIUM

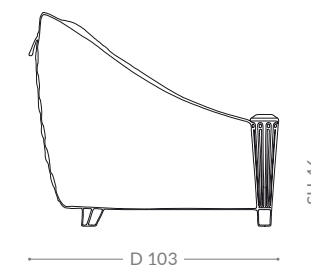
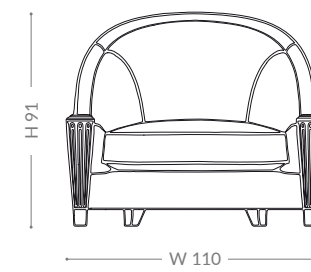

LOPEZ

ARMCHAIR



Struttura in legno massello con piedini in legno intagliato a mano; finitura con borchie. Cuscino di seduta in vera piuma.

Solid wood frame; hand-carved wooden feet. Finished with nails. Seat cushions in natural feather.

Каркас из массива дерева, деревянные ножки ручной работы. Отделка из декоративных гвоздей. Подушки сиденья наполнены натуральным пером.

实木框架；手工雕刻木制沙发脚。镶钉装饰。座垫填充天然羽毛。

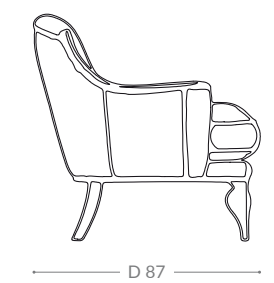
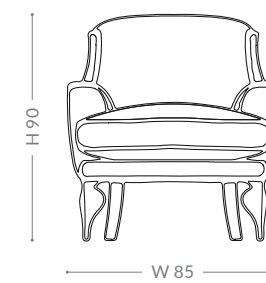

MARYLOU

ARMCHAIR

Struttura in legno massello con piedini in noce canaletto; parte esterna in capitonné. Cuscino di seduta in poliuretano a quote differenziate.

Solid wood frame; canaletto walnut wooden feet. Capitonné outer body. Multiple densities polyurethane foam seating.

Каркас из массива дерева, деревянные ножки из ореха каналетто. Внешняя часть корпуса с обивкой в виде каретной стяжки. Сиденье наполнено пенополиуретаном разной плотности.

实木框架；卡纳莱托胡桃木沙发脚。外侧部分采用分块铆钉装饰。座位填充多重密度聚氨酯泡沫。



As picture: Marylou armchair
In price list: Ambition

Poltrona/Armchair/Кресло/扶手沙发椅
BZ 905-5049 LEATHER DARK BLUE

Lucidatura/Finishing/Отделка/饰面
70. CANALETTO WALNUT MATT

MARYLOU

ARMCHAIR



ARMCHAIRS

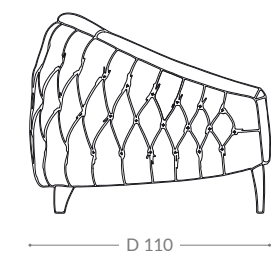
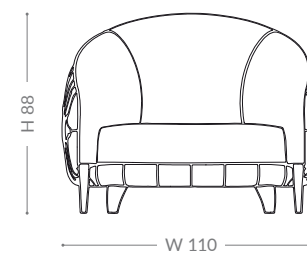

As picture: Marylou armchair
In price list: Exclusive

Poltrona/Armchair/Кресло/扶手沙发椅
BZ 906-2030 LEATHER BURGUNDY
BZ 203-008 BOUCLÉ PLUM

Lucidatura/Finishing/Отделка/饰面
70. CANALETTO WALNUT MATT

PANDORA

ARMCHAIR



Struttura in legno massello e basamento in metallo martellato. Schienale e parte esterna ricamati. Seduta e schiena in poliuretano a quote differenziate.

Solid wood frame; hammered metal base. Quilted backrest and outer body. Multiple densities polyurethane foam seating and backrest.

Каркас из массива дерева, чеканная металлическая основа. Стеганные спинка и внешняя часть корпуса. Сиденье и спинка наполнены пенополиуретаном разной плотности.

实木框架；锻造金属底座。绗缝靠背和外侧部分。座位和靠背填充多重密度聚氨酯泡沫。



As picture: Pandora armchair
In price list: Ambition

Poltrona/Armchair/Кресло/扶手沙发椅
BZ 905-5047 LEATHER DARK GREEN

Parti in metallo/Metal parts/Металлическая фурнитура/金属部件
HAMMERED TITANIUM

PANDORA

ARMCHAIR



ARMCHAIRS

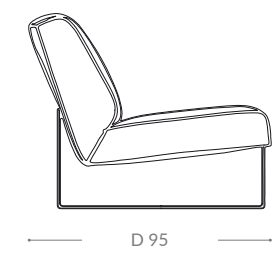
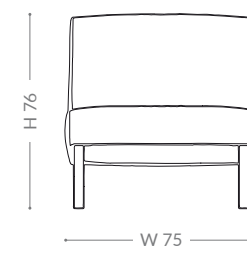

As picture: Pandora armchair
In price list: Ambition

Poltrona/Armchair/Кресло/扶手沙发椅
BZ 906-2023 LEATHER CARAMEL

Parti in metallo/Metal parts/Металлическая фурнитура/金属部件
HAMMERED GOLD

WALLY

ARMCHAIR



Struttura in legno massello sagomato. Cuscino seduta in poliuretano a quote differenziate.

Solid shaped wooden frame. Multiple densities polyurethane foam seating.

Резной каркас из массива дерева. Сиденье наполнено пенополиуретаном разной плотности.

实木型材框架。座位填充多重密度聚氨酯泡沫。

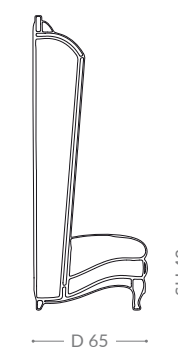
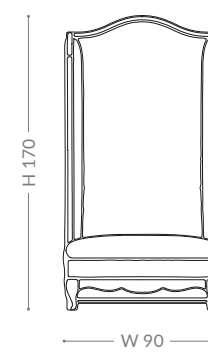

As picture: Wally armchair
In price list: Prime/Brilliant

Poltrona/Armchair/Кресло/扶手沙发椅
BZ 187-153 VELVET LOBSTER

Lucidatura/Finishing/Отделка/饰面
57. CHOCOLATE

COLETTE

DORMEUSE



Struttura in legno massello; basamento in metallo satinato. Schienale con lavorazione capitonné. Cuscino seduta in poliuretano a quote differenziate.

Solid wood frame; satin metal base. Capitonné backrest. Multiple densities polyurethane foam seating.

Каркас из массива дерева, металлическая основа. Спинка с обивкой в виде каретной стяжки. Сиденье наполнено пенополиуретаном разной плотности.

实木框架；金属底座。靠背采用分块铆钉装饰。座位填充多重密度聚氨酯泡沫。

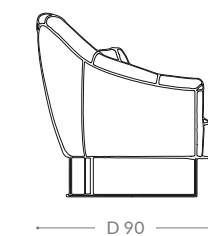
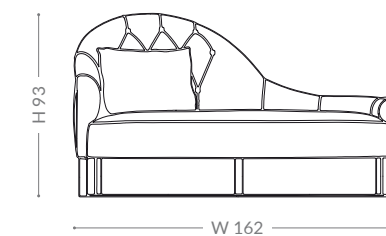
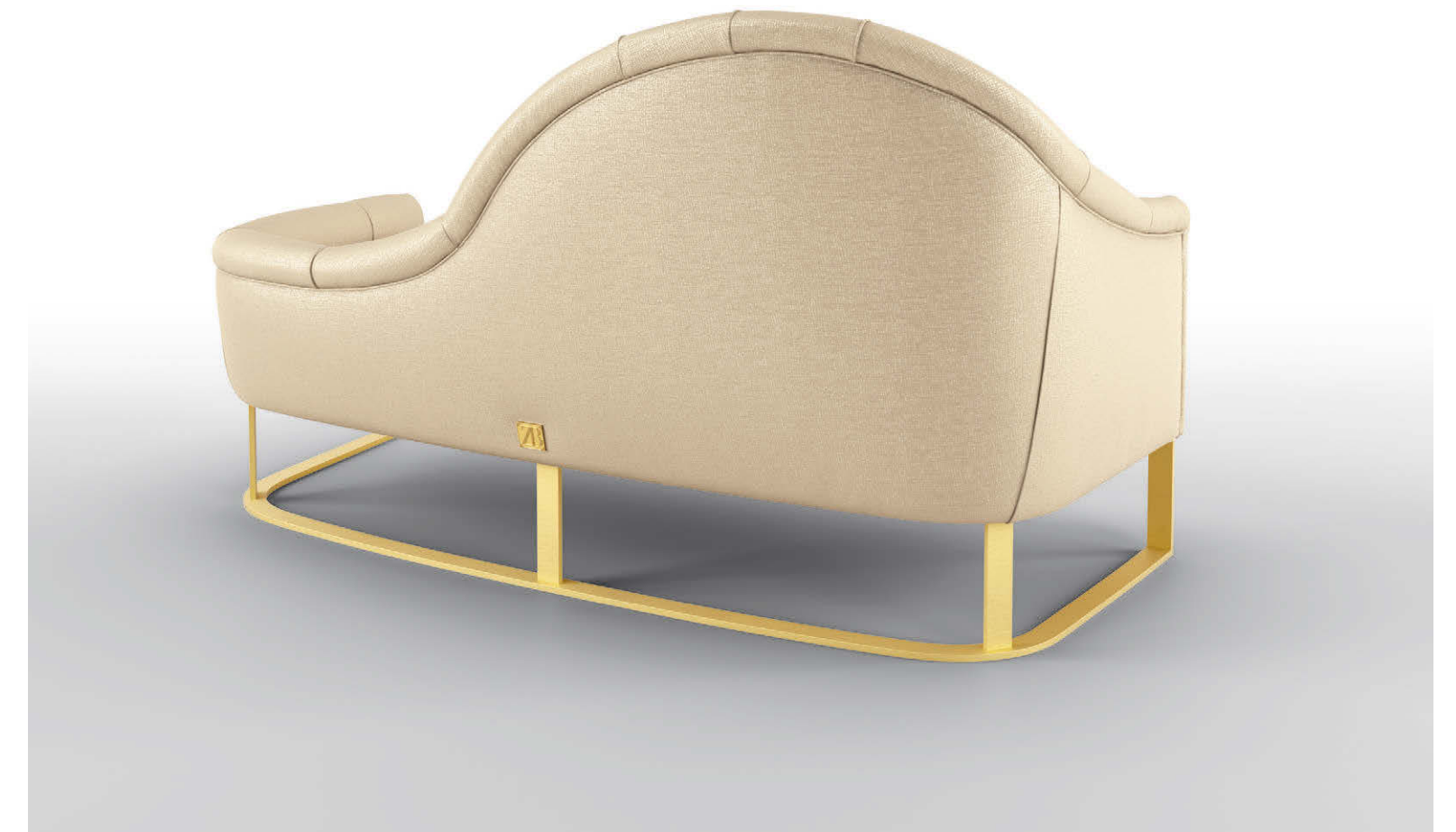

1 cuscino incluso
1 pillow included
1 подушка в комплекте
含 1 个抱枕

DORMEUSE

As picture: Colette dormeuse
In price list: Prestige

Dormeuse/Dormeuse/Кухетка/
沙发躺椅
BZ 126-50 UNITO SAND/PEARL

Cuscini/Pillows/Подушки/抱枕
BZ 187-127 VELVET SAND

Parti in metallo/Metal parts/Металлическая фурнитура/金属部件
SATIN GOLD

GERRIT

DORMEUSE

Struttura in legno massello; basamento in metallo martellato. Seduta e poggiatesta ricamati. Imbottitura in poliuretano a quote differenziate.

Solid wood frame, hammered metal base. Quilted seating and headrest. Multiple densities polyurethane foam padding.

Каркас из массива дерева, чеканная металлическая основа. Стеганные сиденье и подголовник. Набивка из пенополиуретана разной плотности.

实木框架，锻造金属底座。绗缝座位和抱枕。填充多重密度聚氨酯泡沫。



DORMEUSE

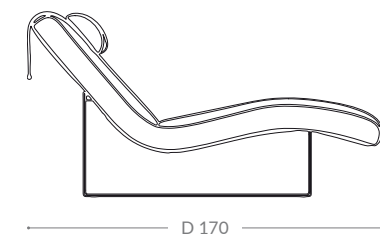
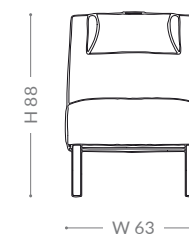

As picture: Gerrit dormeuse
In price list: Ambition

Dormeuse/Dormeuse/Кушетка/
沙发躺椅
BZ 906-2007 LEATHER MOKA

Parti in metallo/Metal parts/Металлическая фурнитура/金属部件
HAMMERED GOLD

GORDON

DORMEUSE



Struttura in legno massello; basamento in legno di faggio. Parte interna trapuntata a righe verticali. Cuscino di seduta in vera piuma con inserto in poliuretano.

Solid wood frame; beechwood base. Vertically decorated quilted inner body. Seat cushion in natural feather with polyurethane insert.

Каркас из массива дерева, основа из бука. Стеганая внутренняя часть корпуса имеет вертикальную отделку. Подушка сиденья наполнена натуральным пером и имеет полиуретановую прокладку.

实木框架；山毛榉底座。内侧部分采用垂直装饰绗缝。坐垫填充天然羽毛和聚氨酯泡沫。



DORMEUSE

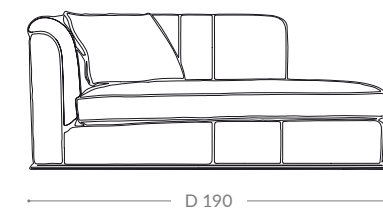
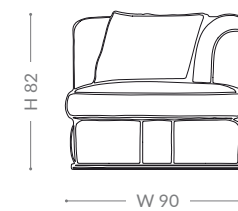

1 cuscino incluso
1 pillow included
1 подушка в комплекте
含 1 个抱枕

As picture: Gordon dormeuse
In price list: Prime

Dormeuse/Dormeuse/Кухетка/
沙发躺椅
BZ 200-502 VELVET DARK GREEN

Cuscini/Pillows/Подушки/抱枕
BZ 184-903 PALMA GREEN

Lucidatura/Finishing/Отделка/饰面
85. CHOCOLATE MATT

LEGEND

DORMEUSE

Struttura in legno massello.
Gamba laterale in legno di faggio con decorazioni in ottone.
Parte interna ricamata; schiena-
le con decorazione a corsetto.
Cuscino di seduta in vera piuma con inserto in poliuretano.

Solid wood frame. Beechwood side leg with brass decoration.
Quilted inner body; outer body with corset decoration. Seat cushion in natural feather with polyurethane insert.

Каркас из массива дерева.
Боковая часть ножки из бука украшена элементами из латуни.
Стеганая внутренняя часть корпуса, внешняя часть корпуса имеет корсетную отделку.
Подушка сиденья наполнена натуральным пером и имеет полиуретановую прокладку.

实木框架。山毛榉侧位沙发脚带有黄铜装饰。绗缝内侧部分；外侧部分采用交叉系绳装饰。坐垫填充天然羽毛和聚氨酯泡沫。

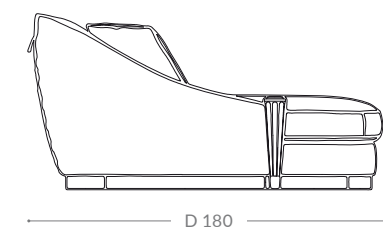
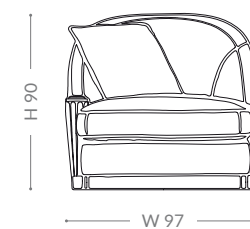

1 cuscino incluso
1 pillow included
1 подушка в комплекте
含 1 个抱枕

DORMEUSE

As picture: Legend dormeuse
In price list: Ambition/Brilliant

Dormeuse/Dormeuse/Кухетка/
沙发躺椅
BZ 905-5141 LEATHER DARK GREY

Cuscini/Pillows/Подушки/抱枕
BZ 191-003 JACQUARD GREY
Lucidatura/Finishing/Отделка/饰面
58. BLACK

Parti in metallo/Metal parts/Метал-
лическая фурнитура/金属部件
TITANIUM

ADAM

POUF



P O U F S

As picture: Adam pouf
In price list: Ambition
Pouf/Pouf/Пуф/沙发脚凳
BZ 906-2023 LEATHER CAMEL

As picture: Adam pouf
In price list: Ambition
Pouf/Pouf/Пуф/沙发脚凳
BZ 905-5047 LEATHER DARK GREEN

As picture: Adam pouf
In price list: Ambition
Pouf/Pouf/Пуф/沙发脚凳
BZ 906-2006 LEATHER TAUPE

Struttura in legno massello.
Imbottitura in poliuretano
a quote differenziate con
lavorazione capitonné.

Solid wood frame. Multiple
densities polyurethane foam
padding with capitonné
decoration.

Каркас из массива дерева.
Набивка из пенополиуретана
разной плотности, отделка в
виде каретной стяжки.

实木框架。填充多重密度聚氨酯泡沫，采用分块铆钉装饰。

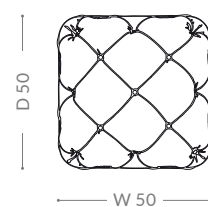
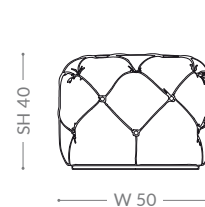

BELLE

POUF

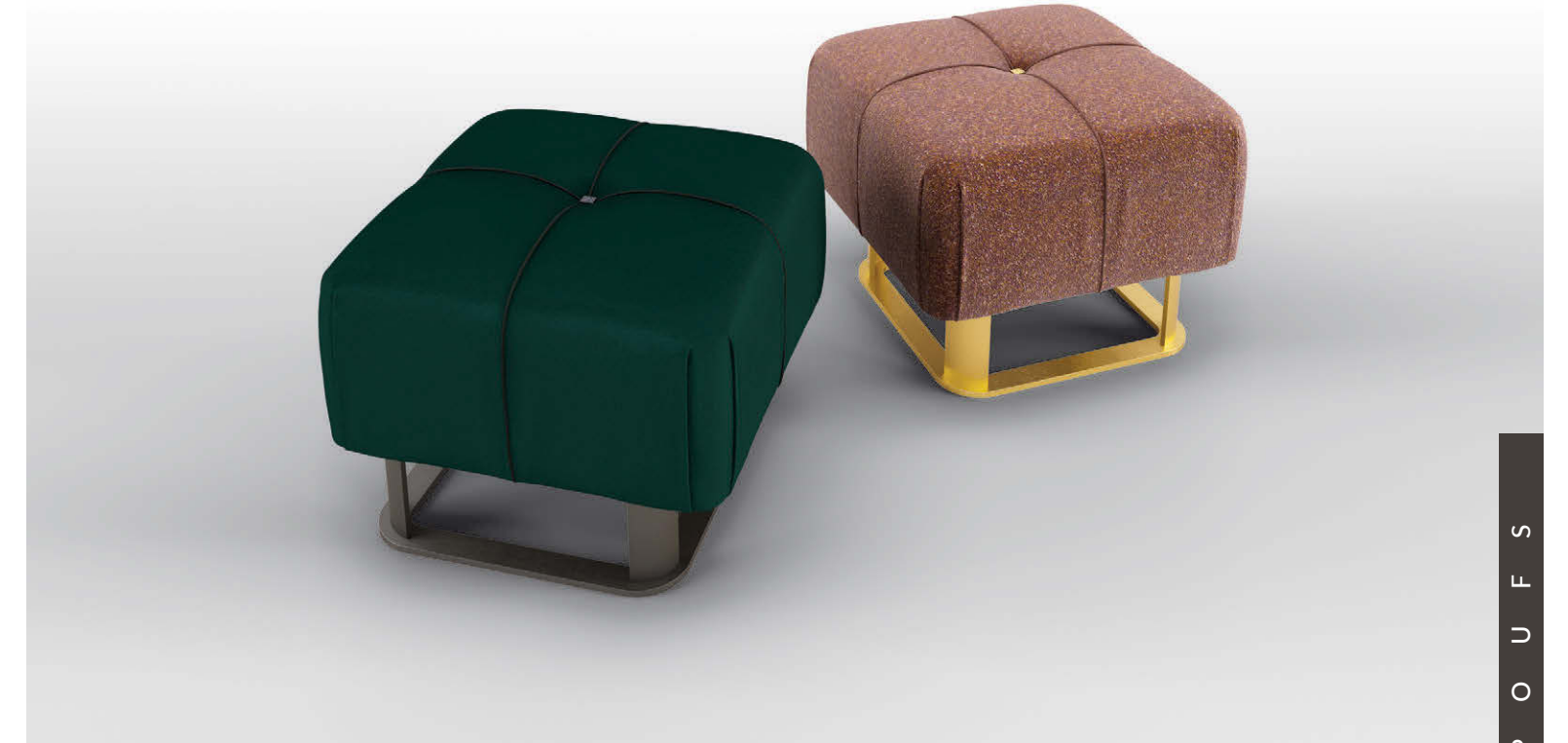

P O U F S

As picture: Belle pouf
In price list: Prime
Pouf/Pouf/Пуф/沙发脚凳
BZ 200-502 VELVET DARK GREEN

Parti in metallo/Metal parts/
Металлическая фурнитура/
金属部件
SATIN TITANIUM

As picture: Belle pouf
In price list: Prestige
Pouf/Pouf/Пуф/沙发脚凳
BZ 211-1120 MELANGE VELVET BURGUNDY

Parti in metallo/Metal parts/
Металлическая фурнитура/
金属部件
SATIN GOLD

Struttura in legno massello;
basamento in metallo.
Imbottitura in poliuretano a
quote differenziate.

Solid wood frame; metal
base. Multiple densities
polyurethane foam padding.

Каркас из массива дерева,
металлическая основа.
Набивка из пенополиуретана
разной плотности.

实木框架；金属底座。填充多重密度聚氨酯泡沫。

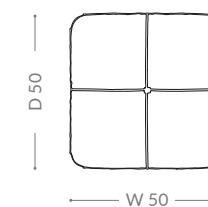
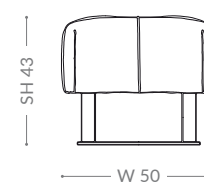

FLY

POUF



P
O
U
F
S

As picture: Fly pouf
In price list: Prestige/Brilliant



Pouf/Pouf/Пюф/沙发脚凳
BZ 126-51 UNITO GREY/PEARL

Lucidatura/Finishing/Отделка/饰面
54. GREY

Struttura in legno massello; basamento in legno sagomato. Cuscino di seduta in vera piuma con inserto in poliuretano.

Solid wood frame; shaped wooden base. Cushion seating in natural feather with polyurethane insert.

Каркас из массива дерева, фигурная деревянная основа. Подушка сиденья наполнена натуральным пером и имеет полиуретановую прокладку.

实木框架；木制型材底座。坐垫填充天然羽毛和聚氨酯泡沫。

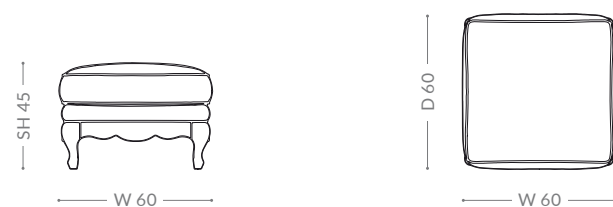

FLY CAPITONNÉ

POUF



As picture: Fly Capitonné pouf
In price list: Prime/Brilliant

Pouf/Pouf/Пюф/沙发脚凳
BZ 200-202 VELVET BURGUNDY



Lucidatura/Finishing/Отделка/饰面
57. CHOCOLATE

P
O
U
F
S

Struttura in legno massello; basamento in legno di faggio sagomato. Seduta in poliuretano con lavorazione capitonné.

Solid wood frame; shaped beechwood base. Polyurethane foam seating with capitonné decoration.

Каркас из массива дерева, фигурная основа из бука. Сиденье из пенополиуретана украшено каретной стяжкой.

实木框架；山毛榉型材底座。聚氨酯泡沫填充座位，采用分块铆钉装饰。

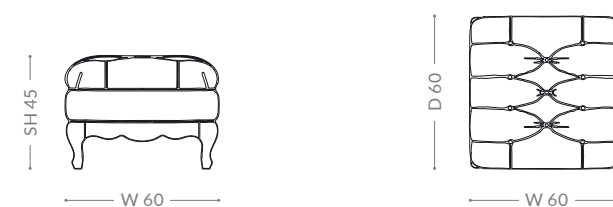

KIMBERLY

POUF

P O U F S



As picture: Kimberly pouf
In price list: Ambition

Pouf/Pouf/Пuf/沙发脚凳
BZ 906-2030 LEATHER BURGUNDY



Lucidatura/Finishing/Отделка/饰面
91. BURGUNDY MATT

Parti in metallo/Metal parts/Металлическая фурнитура/金属部件
GOLD

Struttura in legno massello.
Parte esterna ricamata.
Imbottitura in poliuretano a quote differenziate.

Solid wood frame. Quilted
outer body. Multiple densities
polyurethane foam padding.

Каркас из массива дерева.
Стеганая внешняя часть
корпуса. Набивка из
пенополиуретана разной
плотности.

实木框架。外侧部分绗缝。填充多重密度聚氨酯泡沫。

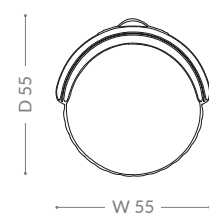
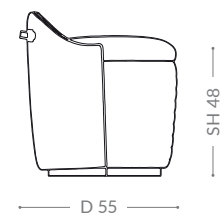
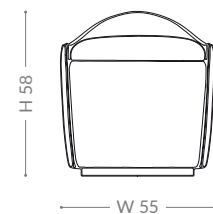

MOON WALT

POUF



As picture: Moon Walt pouf
In price list: Ambition/Brilliant

Pouf/Pouf/Пuf/沙发脚凳
BZ 901-702 LEATHER DOVE GREY



Lucidatura/Finishing/Отделка/饰面
54. GREY

Struttura in legno massello;
basamento in legno decorato.
Parte esterna trapuntata.
Imbottitura in poliuretano
a quote differenziate.

Solid wood frame; decorated
wooden base. Quilted outer
body. Multiple densities
polyurethane foam padding.

Каркас из массива дерева,
деревянная основа с
отделкой. Стеганая внешняя
часть корпуса. Набивка из
пенополиуретана разной
плотности.

实木框架；带装饰木制底座。
外侧部分绗缝。填充多重密度
聚氨酯泡沫。

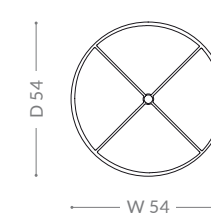
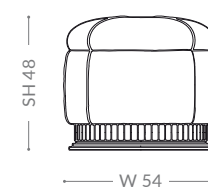

P O U F S

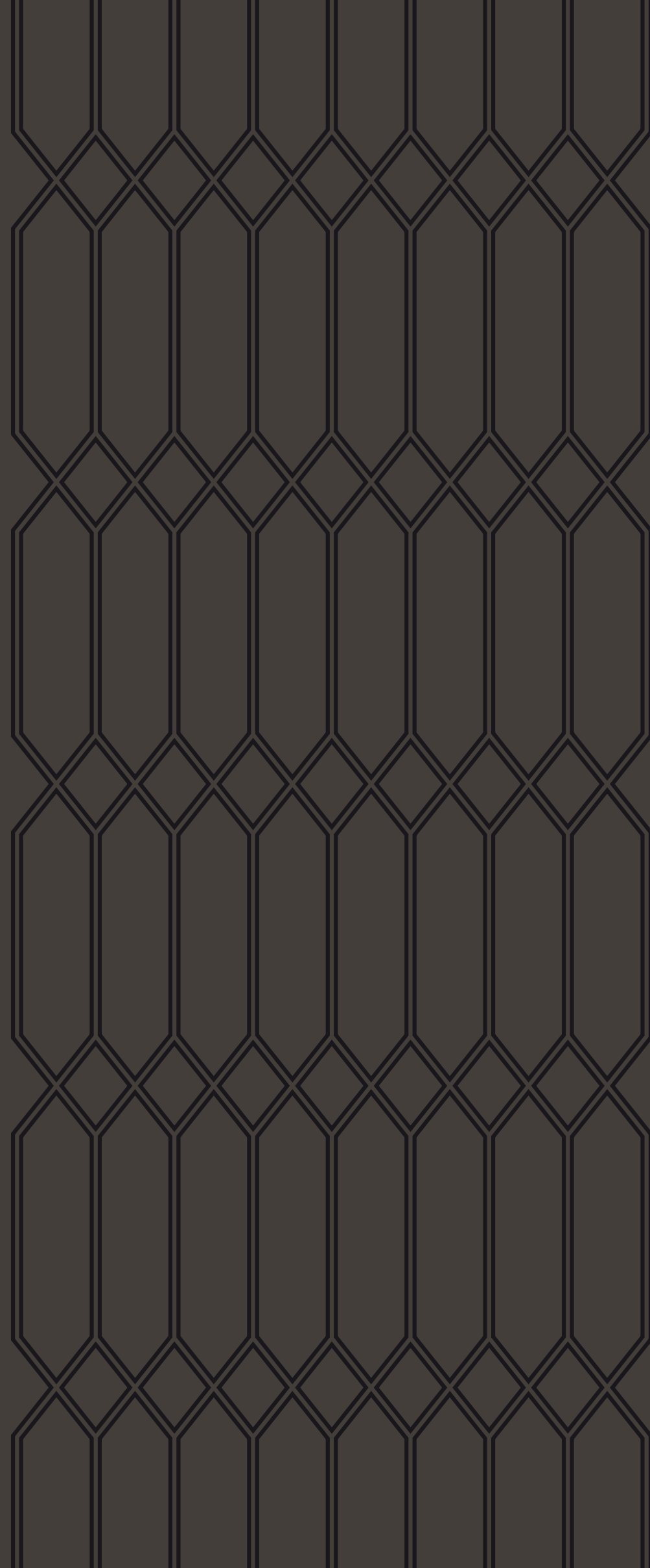

ZB

SOFA TABLES



ALCESTE

SIDE TABLE

SOFA TABLES



As picture: Alceste side table
In price list: Brilliant



Lucidatura/Finishing/Отделка/饰面
98. WENGÉ



Parti in metallo/Metal parts/Металлическая фурнитура/金属部件
SATIN GOLD

Struttura in metallo, finitura disponibile oro satin. Piano disponibile in noce canaletto.

Metal frame; available in satin gold finishing. Top available in canaletto walnut wood.

Металлический каркас, глянцевая золотистая отделка. Деревянная столешница из ореха каналетто.

金属框架；缎面金饰面。选用卡纳莱托胡桃木桌面。

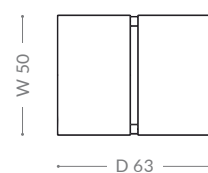
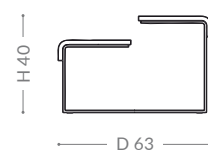
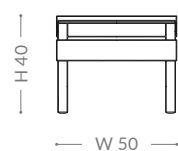

CLUB

CENTRAL TABLE



As picture: Club central table
In price list: Brilliant

Lucidatura/Finishing/Отделка/饰面
54. GREY



Decorazione/Decoration/Декоративный элемент/装饰
BZ 901-702 LEATHER DOVE GREY

Struttura in legno massello; piedini in legno intagliati a mano. Parte centrale in legno con inserto in multistrati decorato con traforo.

Solid wood frame; hand-carved wooden feet. Fretwork plywood decoration.

Каркас из массива дерева, деревянные ножки ручной работы. Резное украшение из фанеры.

实木框架；手工雕刻木制桌脚。胶合板镂空装饰。

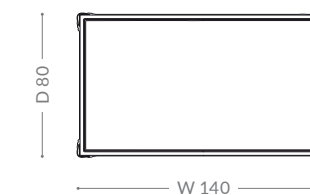
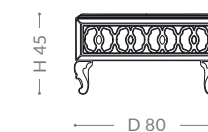

SOFA TABLES

CLUB

SIDE TABLE

S O F A T A B L E S



As picture: Club side table
In price list: Brilliant



Lucidatura/Finishing/Отделка/饰面
57. CHOCOLATE

Decorazione/Decoration/
Декоративный элемент/装饰
BZ 901-215 LEATHER DARK BROWN

Struttura in legno massello; piedini in legno intagliati a mano. Parte centrale in legno con inserto in multistrati decorato con traforo.

Solid wood frame; hand-carved wooden feet. Fretwork plywood decoration.

Каркас из массива дерева, деревянные ножки ручной работы. Резное украшение из фанеры.

实木框架；手工雕刻木制桌脚。胶合板镂空装饰。

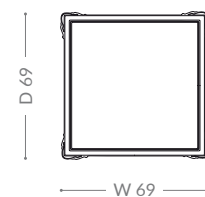
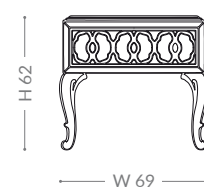

DEA

SIDE TABLE



As picture: Dea side table
In price list: Brilliant

Lucidatura/Finishing/Отделка/饰面
71. WALNUT BRIAR ROOT



Parti in metallo/Metal parts/Металлическая фурнитура/金属部件
SATIN GOLD

Struttura in metallo, finitura disponibile oro satin. Piano disponibile in piuma di noce.

Metal frame; available in satin gold finishing. Top available in walnut briar root.

Металлический каркас, глянцевая золотистая отделка. Доступный материал столешницы: орех бриар.

金属框架；缎面金饰面。桌面选用胡桃根。

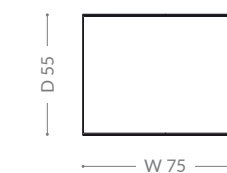
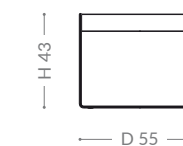
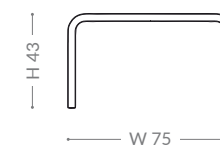

S O F A T A B L E S

DEA

TWIN SET

SOFA TABLES



As picture: Dea twin set
(1 table large + 1 table small)
In price list: Brilliant



Parti in metallo/Metal parts/Металлическая фурнитура/金属部件
SATIN GOLD

Piano/Top/Столешница/桌面
BZ 906-2023 LEATHER CARAMEL
71. WALNUT BRIAR ROOT

Struttura in metallo, finitura disponibile oro satin. Piano disponibile in piuma di noce per tavolino grande; in pelle per tavolino piccolo.

Metal frame; available in satin gold finishing. Top available: walnut briar root for large table, leather for small table.

Металлический каркас, глянцевая золотистая отделка. Столешница из ореха бриар для большого стола, из кожи для маленького стола.

金属框架；缎面金饰面。桌面选用：大桌胡桃根，小桌皮革。

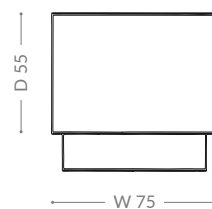
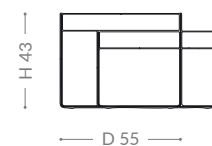
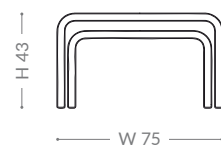

ESEDRA

SIDE TABLE



As picture: Esedra side table
In price list: Brilliant

Lucidatura/Finishing/Отделка/饰面
70. CANALETTO WALNUT MATT

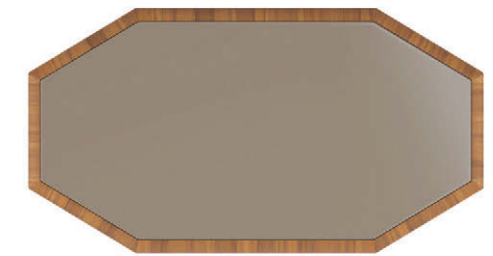

Piano/Top/Столешница/桌面
54. GREY

SOFA TABLES

Struttura in essenza di noce canaletto. Piano disponibile in legno laccato, marmo o legno rivestito in pelle.

Solid wood canaletto walnut frame. Top available in lacquered wood, marble or leather covered wood.

Каркас из массива ореха каналетто. Доступна столешница из лакированной древесины, мрамора или древесины с кожаной обивкой.

卡纳莱托胡桃木实木框架。桌面可选用漆木、大理石或皮革木材。

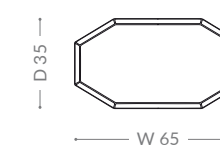
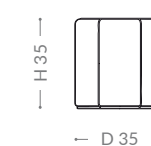
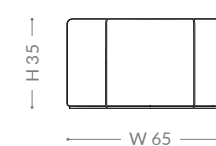

ESEDRA

CENTRAL TABLE SET



SOFA TABLES

As picture: Esedra central table set
In price list: Ambition+Brilliant+Precious stone



Lucidatura/Finishing/Отделка/饰面
70. CANALETTO WALNUT MATT

Piano/Top/Столешница/桌面
54. GREY
BRONZE AMANI
BZ 906-2006 LEATHER TAUPE



Struttura in essenza di noce canaletto. Piano disponibile in legno laccato, marmo o legno rivestito in pelle.

Solid wood canaletto walnut frame. Top available in lacquered wood, marble or leather covered wood.

Каркас из массива ореха каналетто. Доступна столешница из лакированной древесины, мрамора или древесины с кожаной обивкой.

卡纳莱托胡桃木实木框架。桌面可选用漆木、大理石或皮革木材。

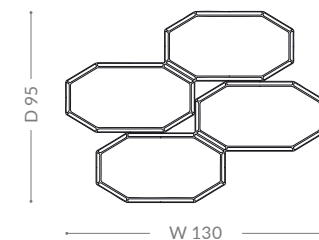
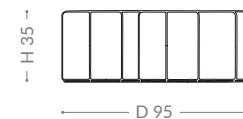
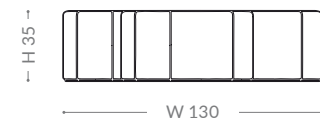

EXPERIA

CENTRAL TABLE



As picture: Experia central table
In price list: Brilliant

Lucidatura/Finishing/Отделка/饰面
69. CANALETTO WALNUT
57. CHOCOLATE

Marmo/Marble/Мрамор/大理石
ROSSO LEPANTO

Struttura in legno massello. Piedini in noce canaletto; piano in marmo.

Solid wood frame. Canaletto walnut wooden feet; marble top.

Каркас из массива дерева. Деревянные ножки из ореха каналетто, столешница из мрамора.

实木框架。胡桃木桌脚；大理石桌面。

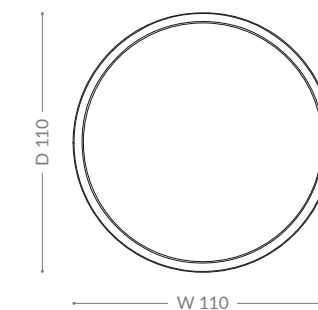
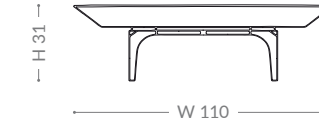

SOFA TABLES

FLY

CENTRAL TABLE



SOFA TABLES



As picture: Fly central table
In price list: Brilliant

Lucidatura/Finishing/Отделка/饰面
54. GREY
63. WHITENED CANALETTO WALNUT

Struttura in legno massello sagomato. Piano disponibile in ebano makassar o noce canaletto.

Solid shaped wood frame. Top available in makassar ebony or canaletto walnut veneer.

Резной каркас из массива дерева. Доступна столешница из шпона макаassarского эбена или ореха каналетто.

实木型材框架。桌面可选望加锡乌木或卡纳莱托胡桃木饰面板。

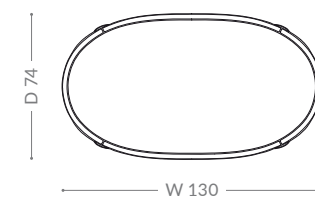
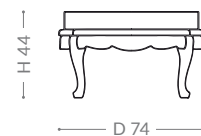
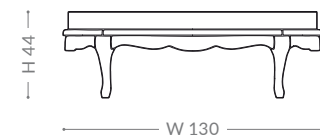

FLY

SIDE TABLE



As picture: Fly side table
In price list: Brilliant

Lucidatura/Finishing/Отделка/饰面
57. CHOCOLATE
65. MAKASSAR

Struttura in legno massello sagomato. Piano disponibile in ebano makassar o noce canaletto.

Solid shaped wood frame. Top available in makassar ebony or canaletto walnut veneer.

Резной каркас из массива дерева. Доступна столешница из шпона макаassarского эбена или ореха каналетто.

实木型材框架。桌面可选望加锡乌木或卡纳莱托胡桃木饰面板。

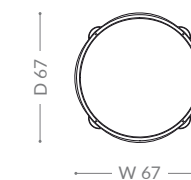
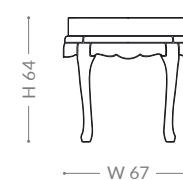

SOFA TABLES

GREY

TABLE SET

SOFA TABLES



As picture: Grey table set
(Grey pouf + Dea side table)
In price list: Brilliant

Pouf/Pouf/Пуф/沙发脚凳
BZ 906-2005 LEATHER OASI



Lucidatura/Finishing/Отделка/饰面
71. WALNUT BRIAR ROOT

Parti in metallo/Metal parts/Металлическая фурнитура/金属部件
SATIN GOLD

Panchetta con struttura in legno massello; realizzata in pelle ricamata. Imbottitura in poliuretano a quote differenziate. Tavolino con struttura in metallo, finitura disponibile oro satin. Piano disponibile in piuma di noce.

Small bench; solid wooden structure. Quilted leather. Multiple densities polyurethane foam padding. Metal frame small table, available in satin gold finishing. Top available in walnut briar root.

Небольшая скамья, конструкция из массива дерева. Стеганая кожа. Набивка из пенополиуретана разной плотности. Маленький столик с металлическим каркасом, золотистая глянцевая отделка. Доступный материал столешницы: орех бриар.

小凳; 实木结构。绗缝皮革。多重密度聚氨酯泡沫填充。金属框架小桌，缎面金色饰面。桌面为胡桃根质地。

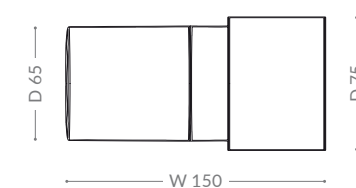
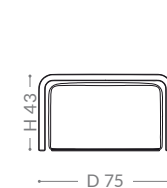
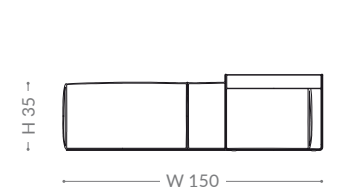

HECTOR

SIDE TABLE



As picture: Hector side table square 78
In price list: Prime

Lucidatura/Finishing/Отделка/饰面
85. CHOCOLATE MATT
70. CANALETTO WALNUT MATT

Base tavolino in legno massello. Piano in multistrati di legno, disponibile in noce canaletto o ebano makassar.

Solid wood base. Plywood top, available in makassar ebony or canaletto veneer.

Основа из массива дерева. Столешница из фанеры, доступна из шпона макассарского эбена и ореха каналетто.

实木底座。胶合板桌面，可选望加锡乌木或卡纳莱托胡桃木饰面板。

HECTOR side table square 78

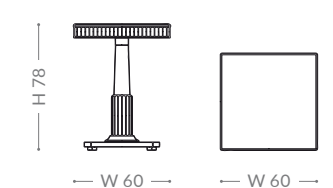

HECTOR side table round 78

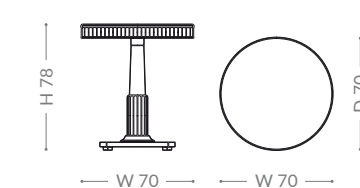

HECTOR side table square 65

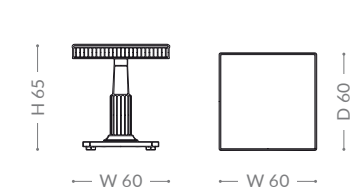

HECTOR side table round 65

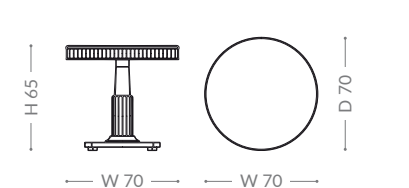

SOFA TABLES

MUMFORD

CENTRAL TABLE



MUMFORD

SIDE TABLE

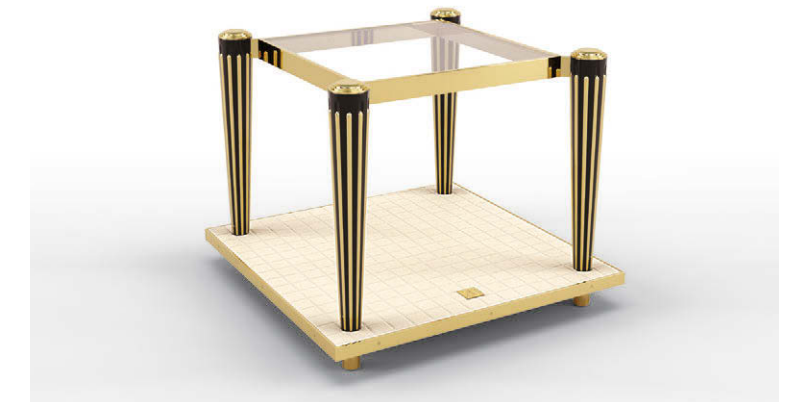

SOFA TABLES



As picture: Mumford central table
In price list: Brilliant

Lucidatura/Finishing/Отделка/饰面
57. CHOCOLATE

Parti in metallo/Metal parts/Металлическая фурнитура/金属部件
TITANIUM

Decorazione/Decoration/Декоративный элемент/装饰
BZ 904-4632 LEATHER SAND

Struttura in metallo. Gambe laterali in legno di faggio con decorazioni in ottone. Base rivestita in pelle ricamata; piano in vetro.

Metal frame. Beechwood legs with brass decoration. Quilted leather base; glass top.

Металлический каркас. Ножки из бука украшены элементами из латуни. Основа из стеганой кожи, стеклянная столешница.

金属框架。黄铜装饰山毛榉桌脚。绗缝皮革底座；玻璃桌面。

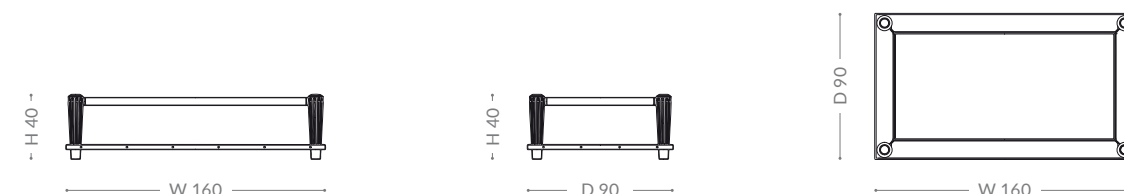

As picture: Mumford side table
In price list: Brilliant

Lucidatura/Finishing/Отделка/饰面
57. CHOCOLATE

Parti in metallo/Metal parts/Металлическая фурнитура/金属部件
GOLD

Decorazione/Decoration/Декоративный элемент/装饰
BZ 901-332 LEATHER BUTTER

Struttura in metallo. Gambe laterali in legno di faggio con decorazioni in ottone. Base rivestita in pelle ricamata; piano in vetro.

Metal frame. Beechwood legs with brass decoration. Quilted leather base; glass top.

Металлический каркас. Ножки из бука украшены элементами из латуни. Основа из стеганой кожи, стеклянная столешница.

金属框架。黄铜装饰山毛榉桌脚。绗缝皮革底座；玻璃桌面。



SOFA TABLES

NEW LINE

RECTANGULAR CENTRAL TABLE



SOFA TABLES

As picture: New Line rectangular central table
In price list: Precious stone



Lucidatura/Finishing/Отделка/饰面
70. CANALETTO WALNUT MATT

Marmo/Marble/Мрамор/大理石
FUSION GREEN

Struttura in noce canaletto massello. Piano disponibile in essenza (noce canaletto), marmo o legno rivestito in pelle.

Solid wood canaletto walnut frame. Top available in wood veneer (canaletto walnut), marble or leather covered wood.

Каркас из массива ореха каналетто. Доступна столешница из деревянного шпона (орех каналетто), мрамора или древесины с кожаной обивкой.

卡纳莱托胡桃木实木框架。桌面可选用木制饰面板（卡纳莱托胡桃木）、大理石或皮革木材。

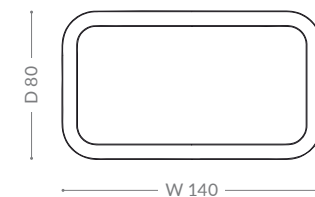
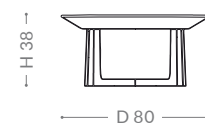
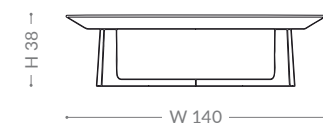

NEW LINE

SQUARE CENTRAL TABLE



As picture: New Line square central table
In price list: Ambition

Lucidatura/Finishing/Отделка/饰面
93. WENGÉ MATT

Materiale/Material/Материал/材料
BZ 906-2023 LEATHER CARAMEL

Struttura in noce canaletto massello. Piano disponibile in essenza (noce canaletto), marmo o legno rivestito in pelle.

Solid wood canaletto walnut frame. Top available in wood veneer (canaletto walnut), marble or leather covered wood.

Каркас из массива ореха каналетто. Доступна столешница из деревянного шпона (орех каналетто), мрамора или древесины с кожаной обивкой.

卡纳莱托胡桃木实木框架。桌面可选用木制饰面板（卡纳莱托胡桃木）、大理石或皮革木材。

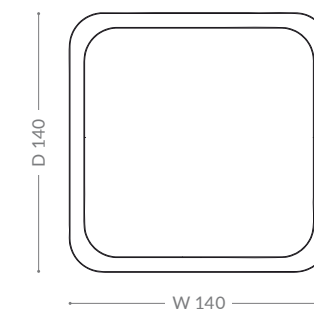
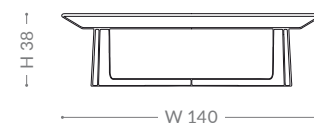

SOFA TABLES

NEW LINE

SIDE TABLE

S O F A T A B L E S

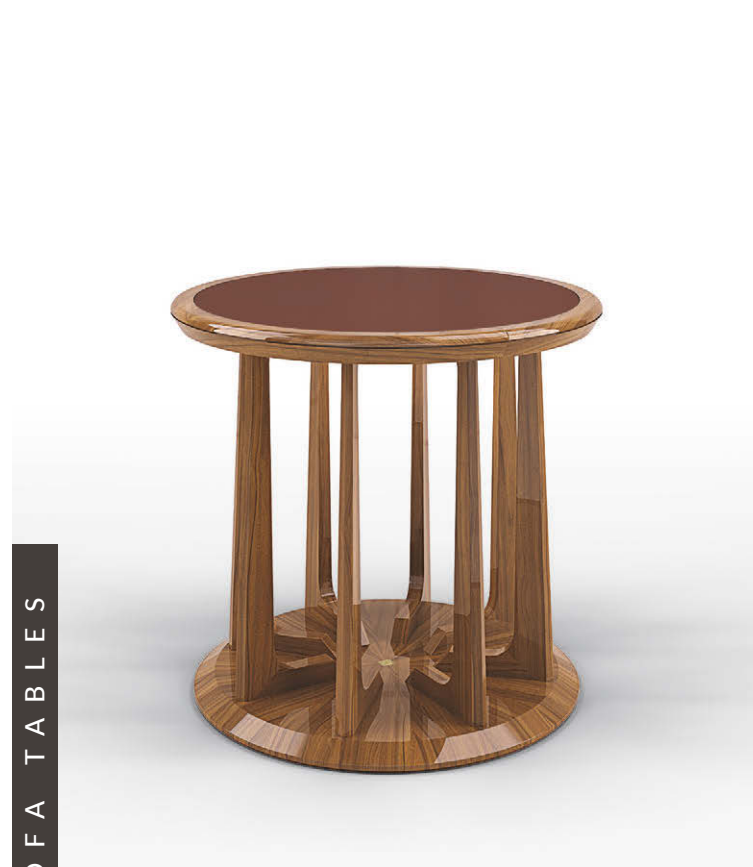

As picture: New Line side table
In price list: Ambition/Brilliant



Lucidatura/Finishing/Отделка/饰面
69. CANALETTO WALNUT

Materiale/Material/Материал/
材料
BZ 906-2030 LEATHER BURGUNDY

Struttura in noce canaletto massello. Piano disponibile in essenza (noce canaletto), marmo o legno rivestito in pelle.

Solid wood canaletto walnut frame. Top available in wood veneer (canaletto walnut), marble or leather covered wood.

Каркас из массива ореха каналетто. Доступна столешница из деревянного шпона (орех каналетто), мрамора или древесины с кожаной обивкой.

卡纳莱托胡桃木实木框架。桌面可选用木制饰面板（卡纳莱托胡桃木）、大理石或皮革木材。

NEW LINE

SIDE TABLE



As picture: New Line side table
In price list: Precious stone



Lucidatura/Finishing/Отделка/饰面
70. CANALETTO WALNUT MATT

Marmo/Marble/Мрамор/大理石
MACAUBAS GIOTTO

S O F A T A B L E S

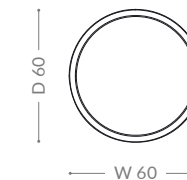
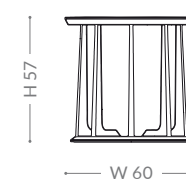

OLIVER

CENTRAL TABLE

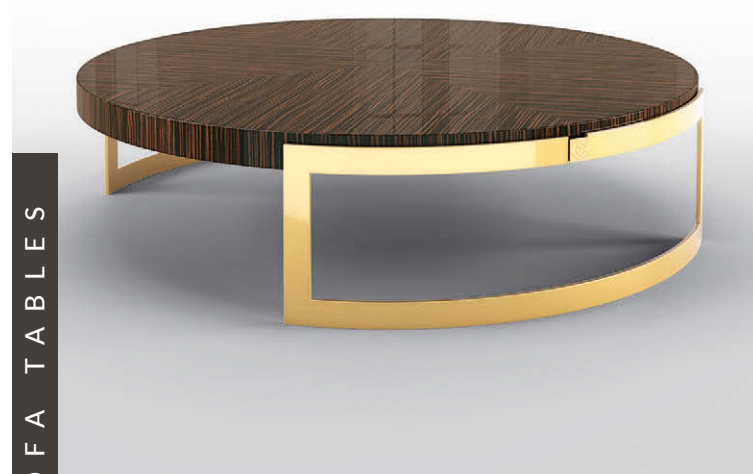

SOFA TABLES

As picture: Oliver central table
In price list: Brilliant



Lucidatura/Finishing/Отделка/饰面
65. MAKASSAR

Parti in metallo/Metal parts/Металлическая фурнитура/金属部件
61. DIAMOND GOLD

Struttura in acciaio; piano disponibile in noce canaletto o ebano makassar.

Steel frame. Top available in canaletto walnut or makassar ebony veneer.

Стальной каркас. Доступна столешница из шпона ореха каналетто или макассарского эбена.

钢制框架。桌面可选卡纳莱托胡桃木或望加锡乌木饰面板。

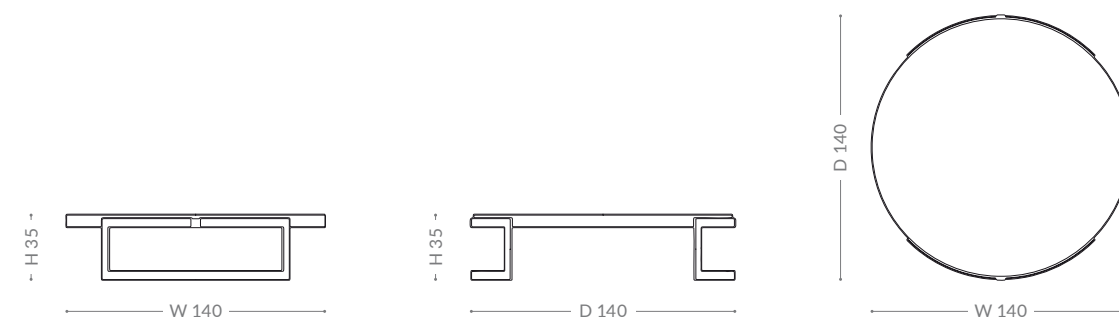

OLIVER

SIDE TABLE



As picture: Oliver side table
In price list: Brilliant



Lucidatura/Finishing/Отделка/饰面
63. WHITENED CANALETTO WALNUT

Parti in metallo/Metal parts/Металлическая фурнитура/金属部件
61. DIAMOND GOLD

Struttura in acciaio; piano disponibile in noce canaletto o ebano makassar.

Steel frame. Top available in canaletto walnut or makassar ebony veneer.

Стальной каркас. Доступна столешница из шпона ореха каналетто или макассарского эбена.

钢制框架。桌面可选卡纳莱托胡桃木或望加锡乌木饰面板。

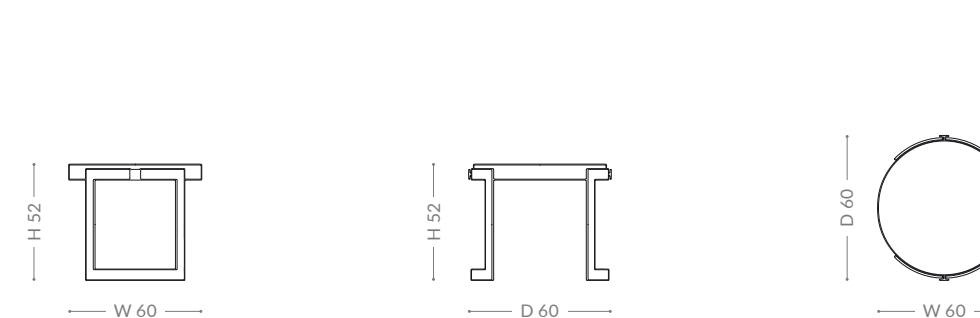

SOFA TABLES

OLIVER

COURTESY TABLE

S O F A T A B L E S



As picture: Oliver courtesy table
In price list: Brilliant

Struttura in acciaio; piano disponibile in noce canaletto o ebano makassar.

Steel frame. Top available in canaletto walnut or makassar ebony veneer.

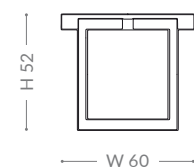

Lucidatura/Finishing/Отделка/饰面
64. CANALETTO WALNUT

Стальной каркас. Доступна столешница из шпона ореха каналетто или макассарского эбена.

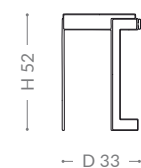

Parti in metallo/Metal parts/Металлическая фурнитура/金属部件
54. GREY

钢制框架。桌面可选卡纳莱托胡桃木或望加锡乌木饰面板。

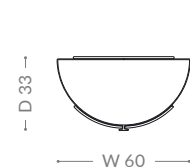

OTTO

CENTRAL TABLE



As picture: Otto central table
In price list: Brilliant

Struttura realizzata in legno massello, multistrati di legno e MDF. Piano in noce canaletto.

Lucidatura/Finishing/Отделка/饰面
57. CHOCOLATE
64. CANALETTO WALNUT

Solid wood frame, plywood and MDF. Canaletto walnut wooden top.



S O F A T A B L E S

Каркас из массива дерева, фанера и МДФ. Деревянная столешница из ореха каналетто.

实木框架，胶合板和密度板。卡纳莱托胡桃木桌面。

OTTO

CENTRAL TABLE



As picture: Otto central table
In price list: Prime

Lucidatura/Finishing/Отделка/饰面
100. GREY MATT
73. CANALETTO WALNUT MATT

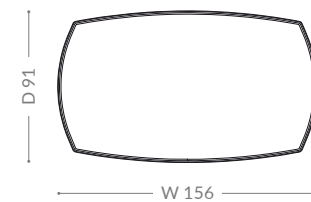
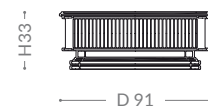
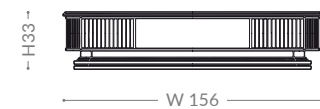

RUPERT

CENTRAL TABLE

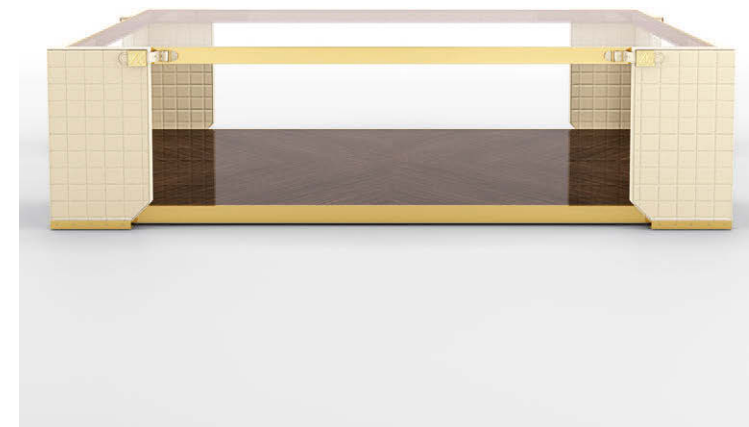

As picture: Rupert central table
In price list: Brilliant

Lucidatura/Finishing/Отделка/饰面
65. EBANO MAKASSAR

Struttura in metallo. Gambe decorate con pelle ricamata. Base disponibile in ebano makassar o eucalipto frisé. Piano in vetro.

Metal frame. Quilted leather legs. Base available in makassar ebony or eucalyptus frisé veneer. Glass top.

Parti in metallo/Metal parts/Металлическая фурнитура/金属部件
GOLD

Металлический каркас. Ножки из стеганой кожи. Доступна столешница из шпона макаassarского эбен или эвкалипта. Стекланная столешница.

Decorazione/Decoration/Декоративный элемент/装饰
BZ 901-332 LEATHER BUTTER

金属框架。绗缝皮革桌脚。底座可选望加锡乌木或尤加利木饰面板。玻璃桌面。

S O F A T A B L E S

RUPERT

CENTRAL TABLE

RUPERT

ROUND TABLE

SOFA TABLES



As picture: Rupert central table
In price list: Brilliant

Lucidatura/Finishing/Отделка/饰面
68. EUCALYPTUS FRISÉ

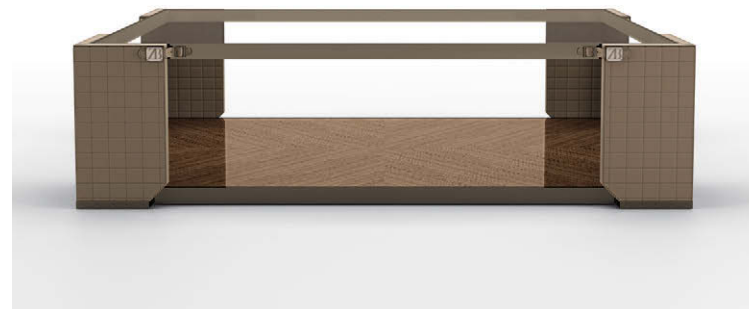

Parti in metallo/Metal parts/Металлическая фурнитура/金属部件
TITANIUM

Decorazione/Decoration/Декоративный элемент/装饰
BZ 901-632 LEATHER LIGHT BROWN

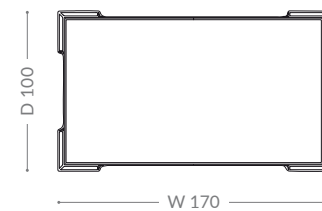
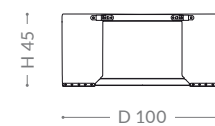
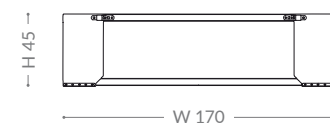

SOFA TABLES

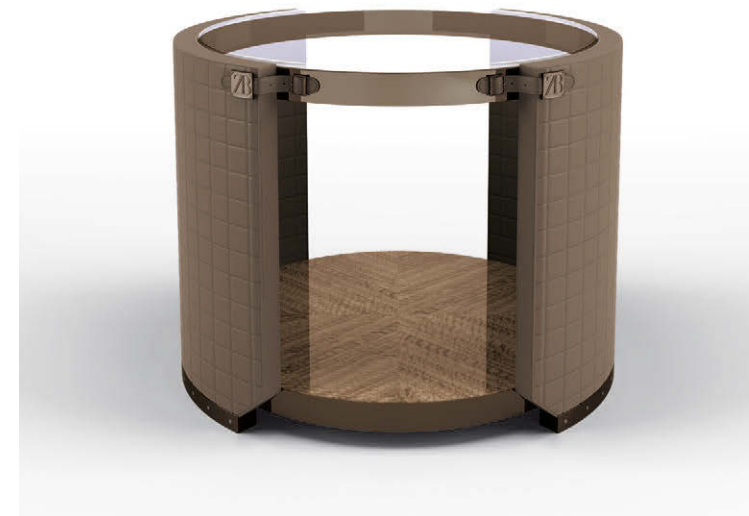

As picture: Rupert round table
In price list: Brilliant

Lucidatura/Finishing/Отделка/饰面
68. EUCALYPTUS FRISÉ



Parti in metallo/Metal parts/Металлическая фурнитура/金属部件
TITANIUM

Decorazione/Decoration/Декоративный элемент/装饰
BZ 901-632 LEATHER LIGHT BROWN

Struttura in metallo. Gambe decorate con pelle ricamata. Base disponibile in ebano makassar o eucalipto frisé. Piano in vetro.

Metal frame. Quilted leather legs. Base available in makassar ebony or eucalyptus frisé veneer. Glass top.

Металлический каркас. Ножки из стеганой кожи. Доступна столешница из шпона макассарского эбен или эвкалипта. Стеклопанельная столешница.

金属框架。绗缝皮革桌脚。底座可选望加锡乌木或尤加利木饰面板。玻璃桌面。

RUPERT

ROUND TABLE

SOFA TABLES



As picture: Rupert round table
In price list: Brilliant

Lucidatura/Finishing/Отделка/饰面
65. MAKASSAR



Parti in metallo/Metal parts/Металлическая фурнитура/金属部件
GOLD

Decorazione/Decoration/Декоративный элемент/装饰
BZ 901-332 LEATHER BUTTER

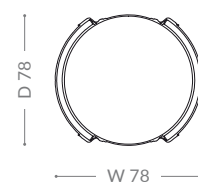
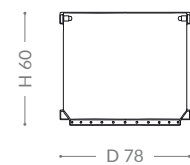
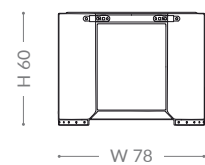

STAN

CENTRAL TABLE



As picture: Stan central table
In price list: Brilliant

Lucidatura/Finishing/Отделка/饰面
94. TAUPE

Struttura in acciaio. Base e piano in multistrati di legno. Disponibile laccato.

Steel frame. Plywood base and top. Available in lacquered finishing.

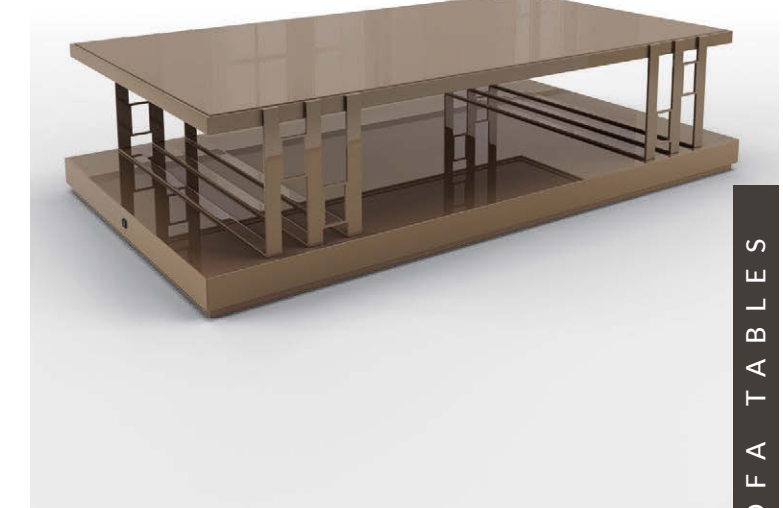
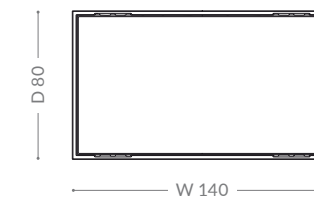
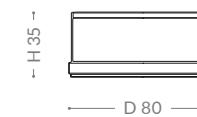
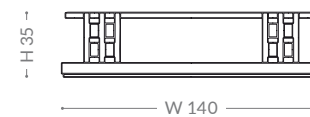

SOFA TABLES

Стальной каркас. Основа и столешница из фанеры. Лаковая отделка.

钢制框架。胶合板底座和桌面。喷漆饰面。

STAN

COURTESY TABLE

S O F A T A B L E S



As picture: Stan courtesy table
In price list: Brilliant

Lucidatura/Finishing/Отделка/饰面
51. SAND

Struttura in acciaio. Base e piano in multistrati di legno. Disponibile laccato.

Steel frame. Plywood base and top. Available in lacquered finishing.

Стальной каркас. Основа и столешница из фанеры. Лаковая отделка.

钢制框架。胶合板底座和桌面。喷漆饰面。

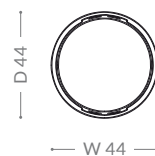
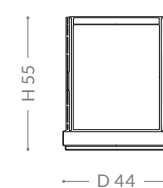
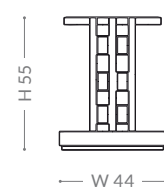

STAN

SIDE TABLE



S O F A T A B L E S

As picture: Stan side table
In price list: Brilliant

Lucidatura/Finishing/Отделка/饰面
96. BURGUNDY

Struttura in acciaio. Base e piano in multistrati di legno. Disponibile laccato.

Steel frame. Plywood base and top. Available in lacquered finishing.

Стальной каркас. Основа и столешница из фанеры. Лаковая отделка.

钢制框架。胶合板底座和桌面。喷漆饰面。

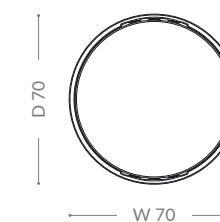
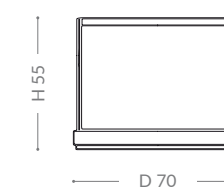
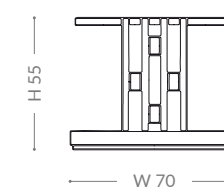

TRITON

CENTRAL TABLE



Base in metallo placcato oro; disponibile con piano in legno laccato, in essenza (ebano makassar, noce canaletto, erable grigio), in essenza con decoro "Wave" o in marmo.

Gold plated metal base; top available in lacquered wood, in wood veneer (makassar ebony, canaletto walnut, grey erable), wood veneer with "Wave" decoration or marble.

Позолоченная металлическая основа, доступна столешница из лакированной древесины, деревянного шпона (макassarский эбен, орех каналетто, серый клен), деревянного шпона с отделкой «волна» или из мрамора.

镀金金属底座；桌面可选漆木、实木（望加锡乌木、卡纳莱托胡桃木、灰雀眼木）、“波纹”装饰实木饰面或大理石。

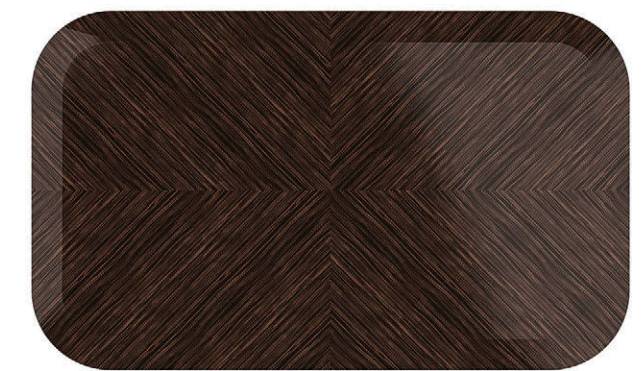
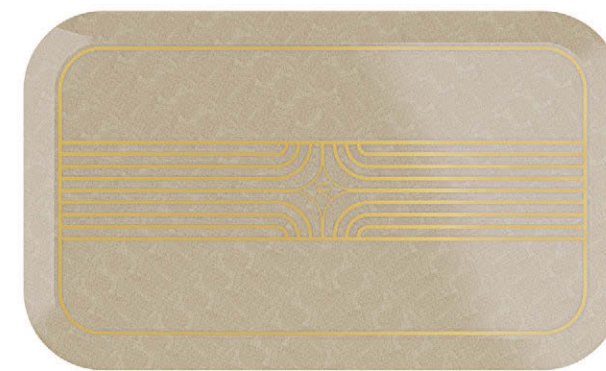

As picture: Triton central table
In price list: Brilliant

Lucidatura/Finishing/Отделка/饰面
65. MAKASSAR
Parti in metallo/Metal parts/Металлическая фурнитура/金属部件
GOLD

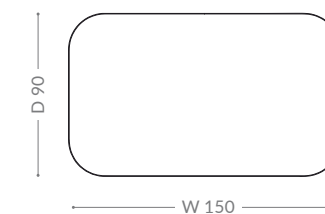
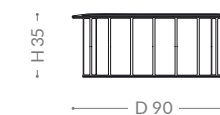
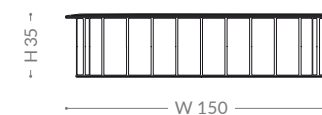

As picture: Triton central table
In price list: Brilliant/Wave decoration

Lucidatura/Finishing/Отделка/饰面
74. ERABLE GREY

Decorazione/Decoration/
Декоративный элемент/装饰
WAVE GOLD

Parti in metallo/Metal parts/Металлическая фурнитура/金属部件
GOLD

TRITON

SQUARE TABLE

SOFA TABLES

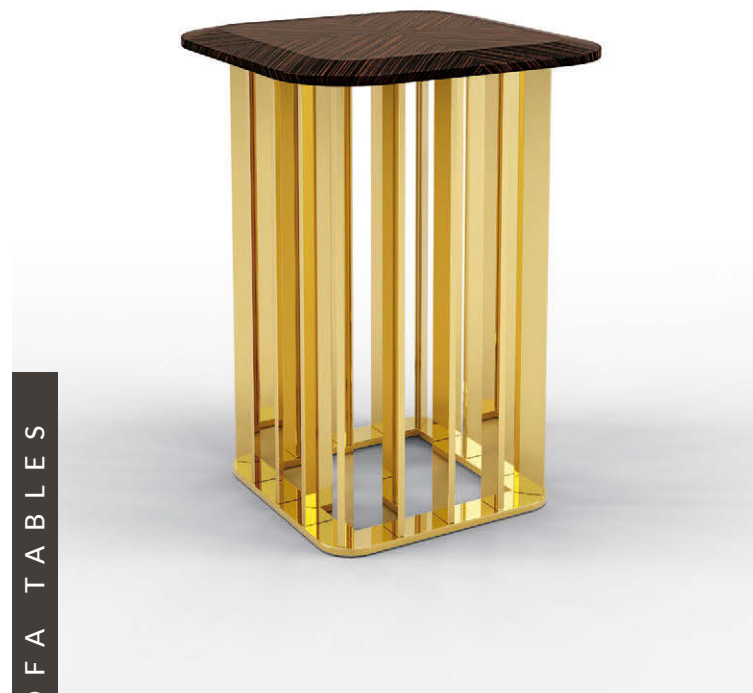

As picture: Triton square table
In price list: Brilliant

Lucidatura/Finishing/Отделка/饰面
65. MAKASSAR

Parti in metallo/Metal parts/Металлическая фурнитура/金属部件
GOLD

Base in metallo placcato oro; disponibile con piano in legno laccato, in essenza (ebano makassar e noce canaletto) o in marmo.

Gold plated metal base; top available in lacquered wood, in wood veneer (makassar ebony, canaletto walnut) or marble.

Позолоченная металлическая основа, доступна столешница из лакированной древесины, деревянного шпона (макаassarский эбен, орех каналетто) или мрамора.

镀金金属底座；桌面可选漆木、实木饰面（望加锡乌木、卡纳莱托胡桃木）或大理石。

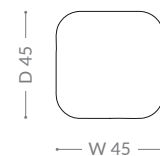
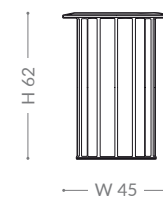

TRITON

ROUND TABLE 45

SOFA TABLES



As picture: Triton round table 45
In price list: Brilliant

Lucidatura/Finishing/Отделка/饰面
69. CANALETTO WALNUT

Parti in metallo/Metal parts/Металлическая фурнитура/金属部件
GOLD

Base in metallo placcato oro; disponibile con piano in legno laccato, in essenza (ebano makassar e noce canaletto) o in marmo.

Gold plated metal base; top available in lacquered wood, in wood veneer (makassar ebony, canaletto walnut) or marble.

Позолоченная металлическая основа, доступна столешница из лакированной древесины, деревянного шпона (макаassarский эбен, орех каналетто) или мрамора.

镀金金属底座；桌面可选漆木、实木饰面（望加锡乌木、卡纳莱托胡桃木）或大理石。

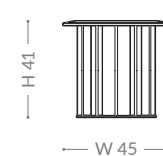

TRITON

ROUND TABLE 60

S O F A T A B L E S

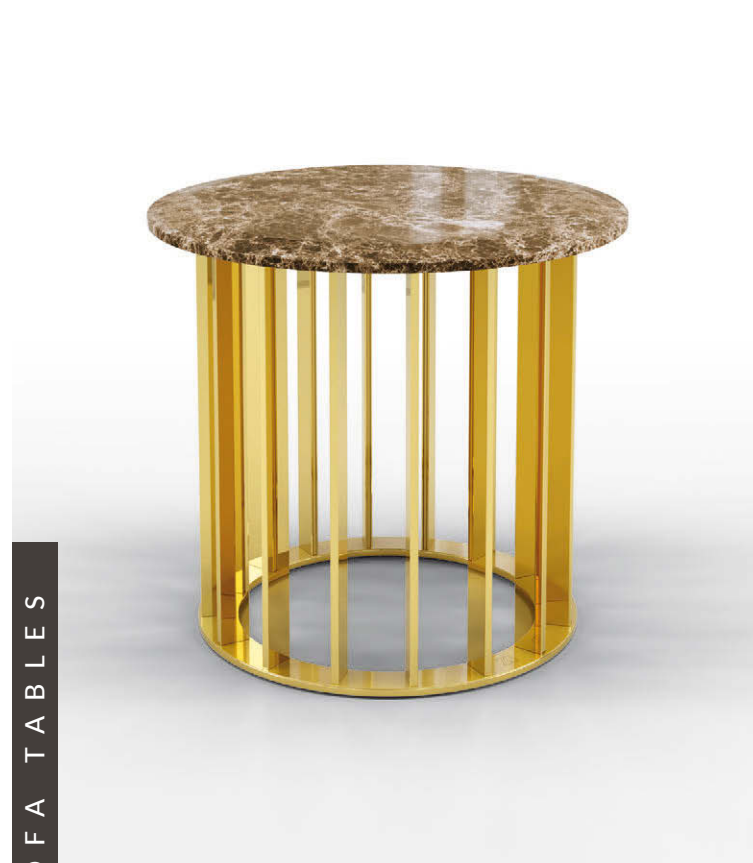

As picture: Triton round table 60
In price list: Precious stone



Marmo/Marble/Мрамор/大理石
EMPERADOR DARK

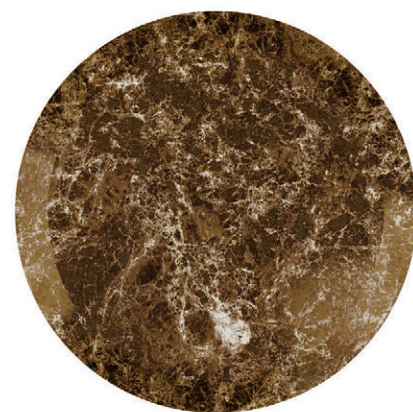

Parti in metallo/Metal parts/Металлическая фурнитура/金属部件
GOLD

Base in metallo placcato oro; disponibile con piano in legno laccato, in essenza (ebano makassar e noce canaletto) o in marmo.

Gold plated metal base; top available in lacquered wood, in wood veneer (makassar ebony, canaletto walnut) or marble.

Позолоченная металлическая основа, доступна столешница из лакированной древесины, деревянного шпона (макassarский эбен, орех каналетто) или мрамора.

镀金金属底座；桌面可选漆木、实木饰面（望加锡乌木、卡纳莱托胡桃木）或大理石。

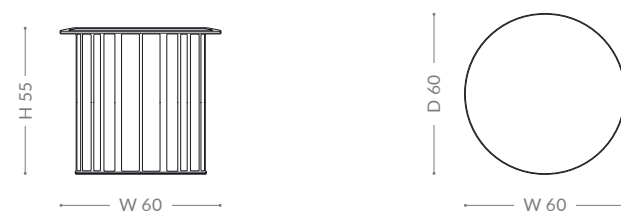

TRITON

COURTESY TABLE



As picture: Triton courtesy table
In price list: Brilliant

Lucidatura/Finishing/Отделка/饰面
54. GREY



Parti in metallo/Metal parts/Металлическая фурнитура/金属部件
GOLD



Base in metallo placcato oro; disponibile con piano in legno laccato o in marmo.

Gold plated metal base; top available in lacquered wood or marble.

Позолоченная металлическая основа, доступна столешница из лакированной древесины или мрамора.

镀金金属底座；桌面可选用漆木或大理石。

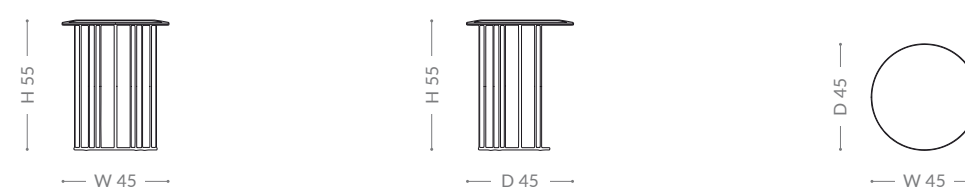

S O F A T A B L E S

TULIP

ROUND TABLE

SOFA TABLES



As picture: Tulip round table
In price list: Prime



Piano/Top/Столешница/桌面
BRONZE GLASS



Parti in metallo/Metal parts/Металлическая фурнитура/金属部件
SATIN GOLD

Struttura in metallo; finitura disponibile oro satin. Piano in vetro bronzo (taglio brillante).

Metal frame; available in satin gold finishing. Bronze glass top (diamond beveled edge).

Металлический каркас, золотистая глянцевая отделка. Столешница из бронзового стекла (с факетированным краем).

金属框架；缎面金色饰面。青铜色玻璃桌面（菱形斜边）。

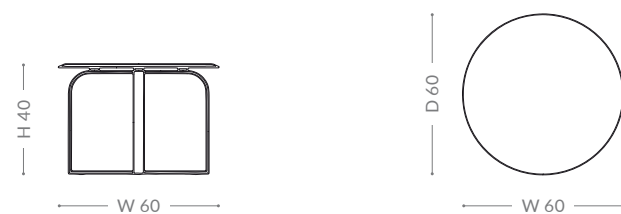

TULIP

SIDE TABLE 35+45



As picture: Tulip side table 35+45
In price list: Prime

Lucidatura/Finishing/Отделка/饰面
93. WENGÉ MATT



Parti in metallo/Metal parts/Металлическая фурнитура/金属部件
SATIN TITANIUM

Struttura in metallo, finitura disponibile titanio satin. Piano disponibile in noce canaletto.

Metal frame; available in satin titanium finishing. Top available in canaletto walnut wood.

Металлический каркас, глянцевая титановая отделка. Деревянная столешница из ореха каналетто.

金属框架；缎面钛合金饰面。选用卡纳莱托胡桃木桌面。

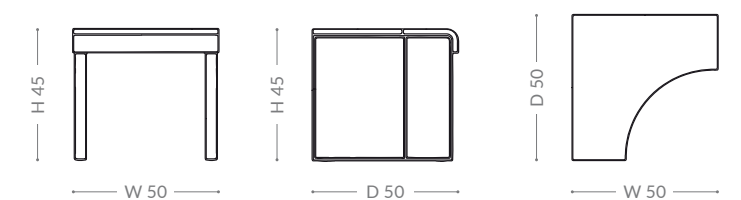
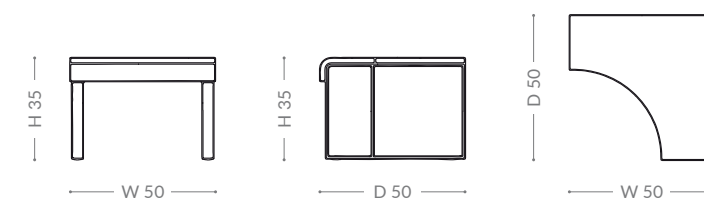

SOFA TABLES

TULIP

TRIS SET

SOFA TABLES



As picture: Tulip tris table
(Tulip round table+Tulip side table 35+Tulip side table 45)
In price list: Brilliant

Struttura in metallo; finitura satin. Piano in vetro bronzo (taglio brillante) per tavolino rotondo; piano in noce canaletto per tavolini laterali.

Metal frame, satin finishing. Bronze glass top (diamond beveled edge) for round table; canaletto walnut wooden top for side tables.



Piano/Top/Столешница/桌面
BRONZE GLASS (round table)
69. CANALETTO WALNUT (side tables)

Металлический каркас, глянцевая отделка. Столешница из бронзового стекла (с фацетированным краем) для круглого столика; столешница из ореха каналетто для приставных столов.

Parti in metallo/Metal parts/Металлическая фурнитура/金属部件
SATIN GOLD (round table)
SATIN TITANIUM (side table)

金属框架，缎面饰面。圆桌为青铜色玻璃桌面（带有菱形斜边）；茶几为卡纳莱托胡桃木桌面。

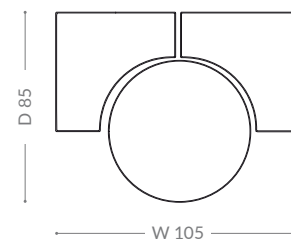
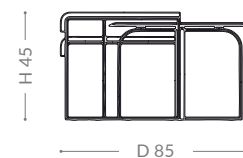
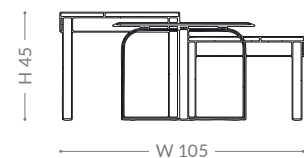

WAVE

CENTRAL TABLE



As picture: Wave central table
In price list: Prime

Struttura in essenza di noce canaletto. Piano in legno laccato.

Lucidatura/Finishing/Отделка/饰面
93. WENGÉ MATT
100. GREY MATT

Canaletto walnut wooden frame. Lacquered wooden top.



SOFA TABLES

Каркас из древесины ореха каналетто. Столешница из лакированной древесины.

卡纳莱托胡桃木框架。漆木桌面。

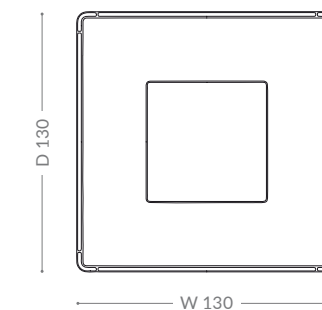

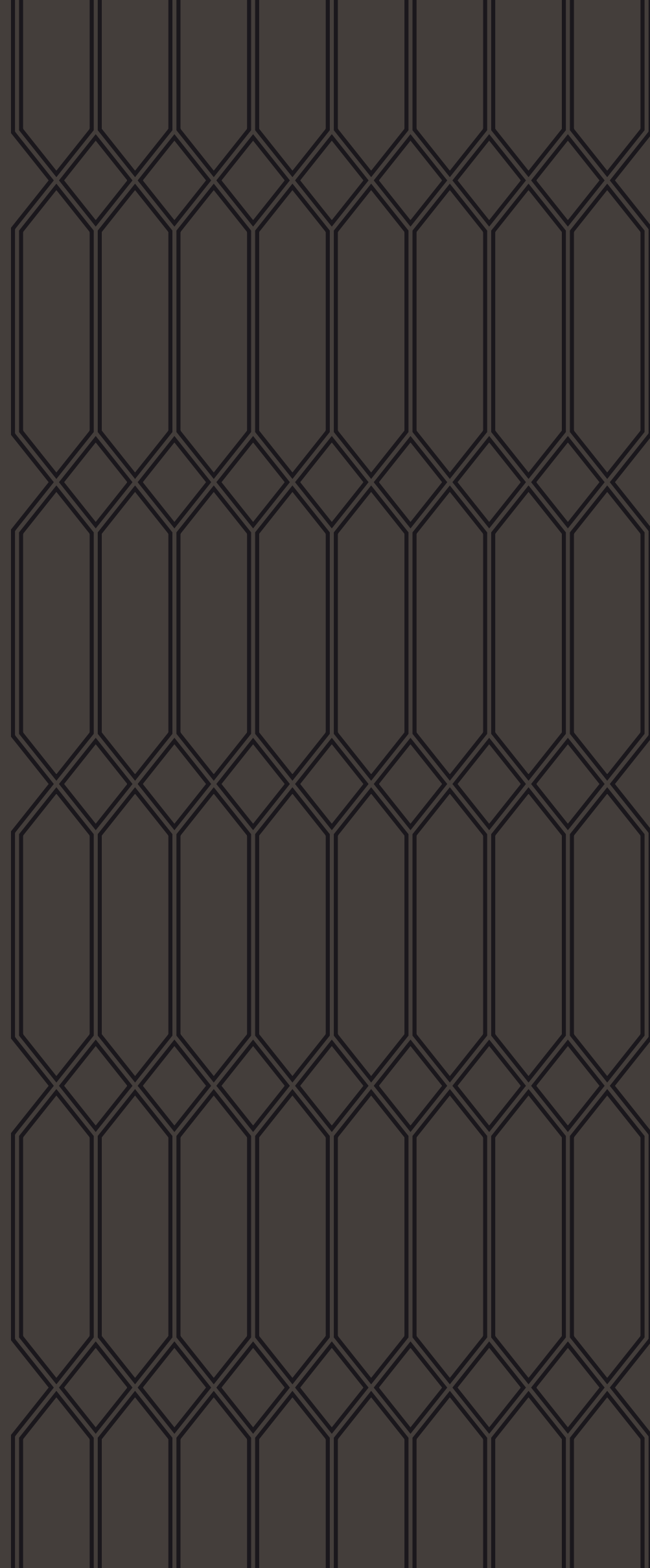

ZB

DINING TABLES



BOSTON

RECTANGULAR DINING TABLE



Struttura in legno massello. Base unica in legno con decori in ottone. Piano disponibile in noce canaletto o ebano makassar, con inserto in marmo o onice. Decorazioni perimetrali in metallo.

Solid wood frame. Single wooden base with brass decoration. Top available in canaletto walnut or makassar ebony veneer, with marble or onyx inlay. Top edge metal profile.

Каркас из массива дерева. Деревянная основа с одной ножкой и отделкой из латуни. Доступна столешница из шпона макаassarского эбена или ореха каналетто со вставкой из мрамора или оникса. Металлический профиль верхней кромки.

实木框架。黄铜装饰木制单底座。桌面可选用望加锡乌木或卡纳莱托胡桃木饰面板（镶大理石或缟玛瑙）。金属型材桌边。

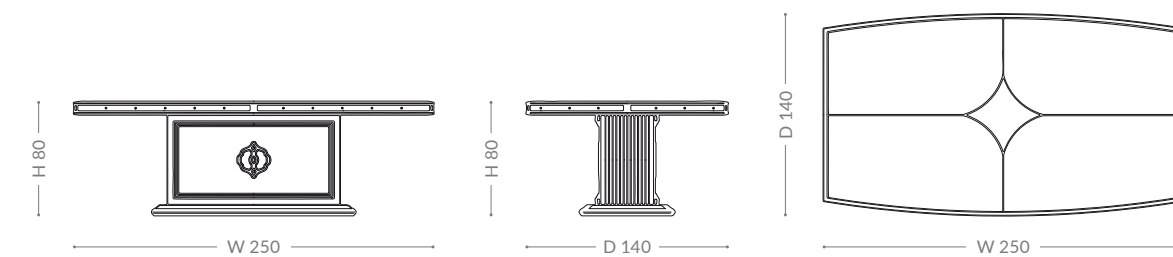

BOSTON
rectangular cm 250

DINING TABLES

As picture: Boston rectangular dining table
In price list: Brilliant

Lucidatura/Finishing/Отделка/饰面
94. TAUPE - 98. WENGÉ
61. DIAMOND GOLD

Marmo/Marble/Мрамор/大理石
BRONZE AMANI

Parti in metallo/Metal parts/Металлическая фурнитура/金属部件
GOLD

BOSTON WIDE

RECTANGULAR DINING TABLE



Struttura in legno massello. Due basi in legno con decori in ottone. Piano disponibile in noce canaletto o ebano makassar, con inserto in marmo o onice. Decorazioni perimetrali in metallo.

Solid wood frame. Two wooden bases with brass decoration. Top available in canaletto walnut or makassar ebony veneer, with marble or onyx inlay. Top edge metal profile.

Каркас из массива дерева. Две деревянные основы с отделкой из латуни. Доступна столешница из шпона макаassarского эбена или ореха каналетто со вставкой из мрамора или оникса. Металлический профиль верхней кромки.

实木框架。黄铜装饰木制双底座。桌面可选加锡乌木或卡纳莱托胡桃木饰面板（镶大理石或缟玛瑙）。桌面边缘金属型材。



DINING TABLES

As picture: Boston Wide rectangular dining table cm 380
In price list: Brilliant

Lucidatura/Finishing/Отделка/饰面
57. CHOCOLATE
61. DIAMOND GOLD - 65. MAKASSAR

Marmo/Marble/Мрамор/大理石
ONYX HONEY

Parti in metallo/Metal parts/Металлическая фурнитура/金属部件
GOLD

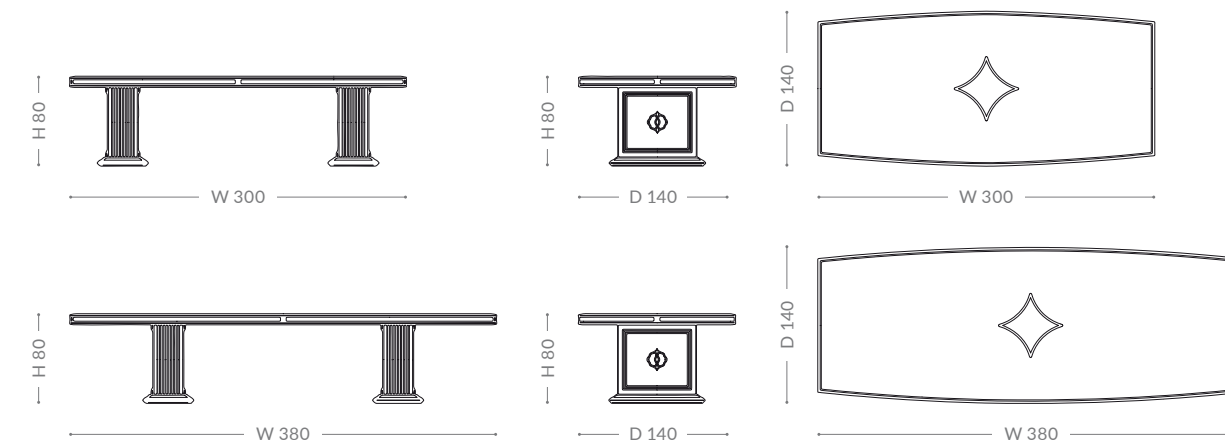

BOSTON WIDE
rectangular cm 300

BOSTON WIDE
rectangular cm 380

BOSTON

ROUND DINING TABLE



Struttura in legno massello. Base in legno con decori in ottone. Piano disponibile in noce canaletto o ebano makassar, con inserto in marmo o onice. Decorazioni perimetrali in metallo. "Lazy Susan" su richiesta.

Solid wood frame. Wooden base with brass decoration. Top available in canaletto walnut or makassar ebony veneer, with marble or onyx inlay. Top edge metal profile. "Lazy Susan" on request.

Каркас из массива дерева. Деревянная основа с отделкой из латуни. Доступна столешница из шпона макассарского эбена или ореха каналетто со вставкой из мрамора или оникса. Металлический профиль верхней кромки. Вращающаяся подставка по запросу.

实木框架。黄铜装饰木制底座。桌面可选加锡乌木或卡纳莱托胡桃木饰面板（镶大理石或玛瑙）。桌面边缘金属型材。可根据要求定制“餐桌转盘”。

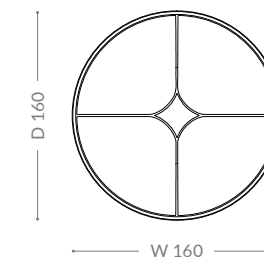
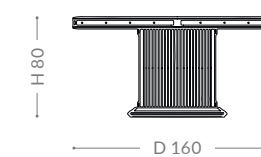

BOSTON round cm 160

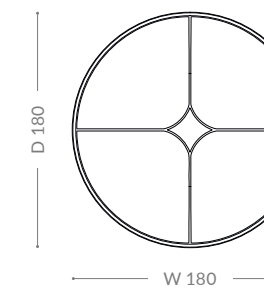
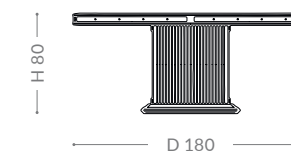
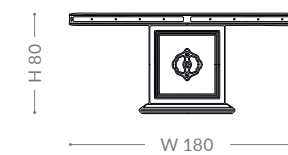

BOSTON round cm 180

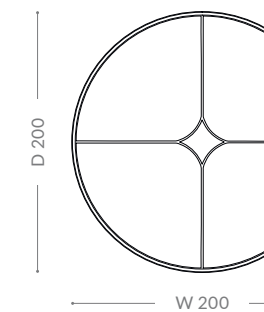
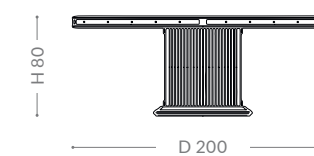
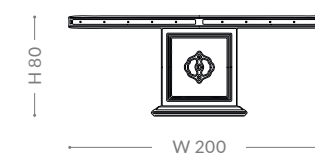

BOSTON round cm 200

DINING TABLES

As picture: Boston round dining table cm 180
In price list: Brilliant/Lazy Susan on request

Lucidatura/Finishing/Отделка/饰面
53. DOVE GREY
63. WHITENED CANALETTO WALNUT

Marmo/Marble/Мрамор/大理石
ONYX WHITE

Parti in metallo/Metal parts/Металлическая фурнитура/金属部件
TITANIUM

GILLON

EXTENSIBLE DINING TABLE

Struttura in metallo satinato e legno noce canaletto massello. Piano disponibile in essenza di noce canaletto o marmo. Il tavolo è fornito con 2 allunghe da cm 50.

Satin metal and solid canaletto walnut frame. Top available in canaletto walnut veneer or marble. With two cm 50 length extensions.

Каркас из массива дерева. Каркас из глянцевого металла и массива ореха каналетто. Доступна столешница из шпона ореха каналетто или из мрамора. С двумя выдвижными поверхностями длиной 50 см.

缎面金属及卡纳莱托胡桃木实木框架。桌面可选卡纳莱托胡桃木饰面板或大理石。两个50 cm 长延长桌面。

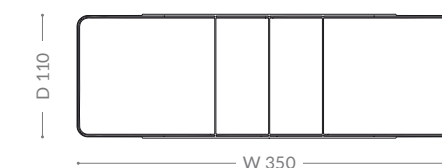
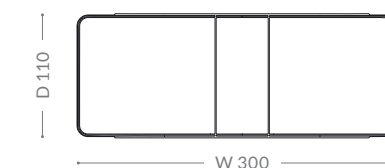
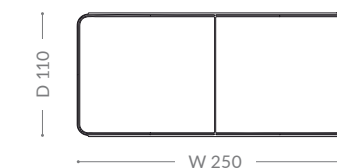
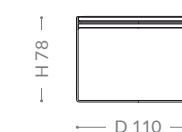
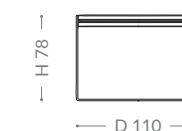
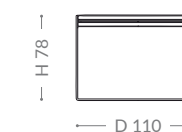
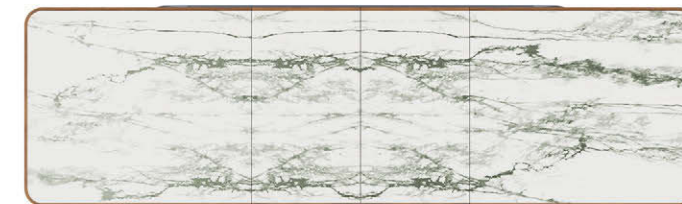
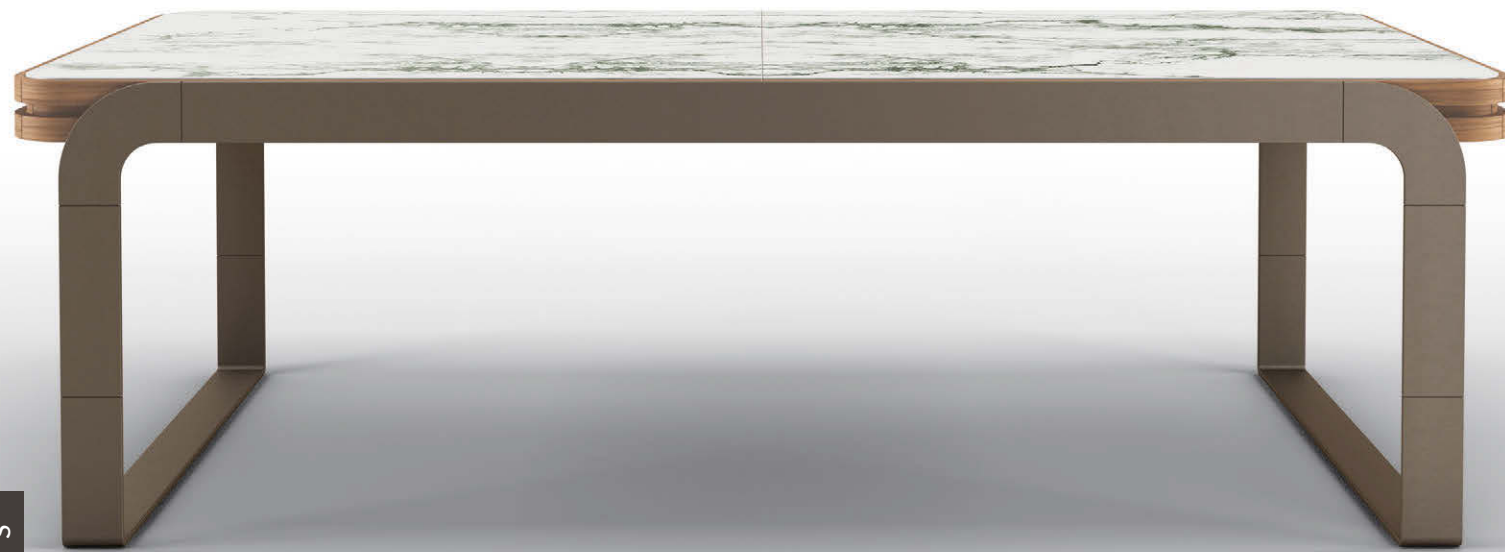

GILLON
extensible cm 250/300/350

DINING TABLES

As picture: Gillon extensible dining table
In price list: Prime/Precious stone

Lucidatura/Finishing/Отделка/饰面
70. CANALETTO WALNUT MATT

Marmo/Marble/Мрамор/大理石
IRISH CALACATTA MATT

Parti in metallo/Metal parts/Металлическая фурнитура/金属部件
SATIN TITANIUM

MANHATTAN

RECTANGULAR DINING TABLE

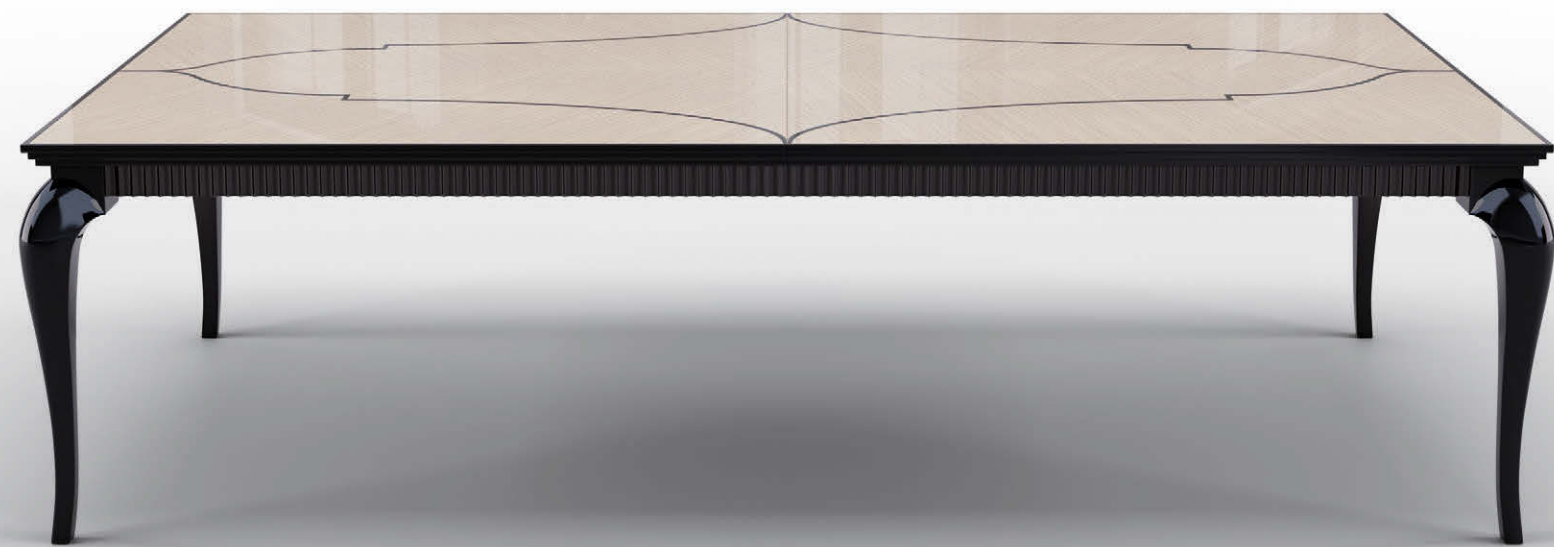

DINING TABLES

As picture: Manhattan rectangular dining table cm 280
In price list: Brilliant

Lucidatura/Finishing/Отделка/饰面
58. BLACK
63. WHITENED CANALETTO WALNUT

Struttura in legno massello.
Piano disponibile in noce
canaletto decorato. Disponibile
con allunghe.

Solid wood frame. Top
available in decorated
canaletto walnut veneer.
Available with length
extensions.

Каркас из массива дерева.
Доступна столешница с
отделкой из шпона ореха
каналетто. Доступна с
выдвижными поверхностями.

实木框架。桌面可选卡纳莱托
胡桃木饰面板，可选延长桌
面。

As picture: Manhattan
extensible cm 280/330/380

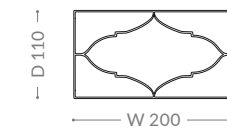
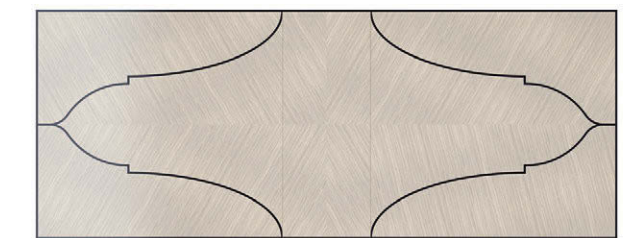
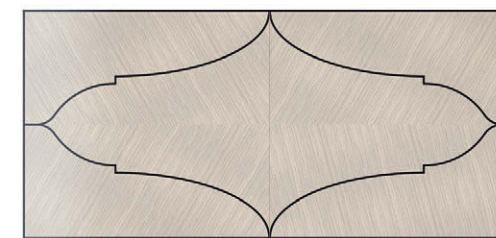

MANHATTAN
rectangular cm 200

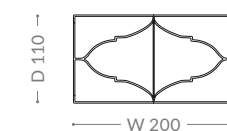

MANHATTAN
rectangular
extensible cm 200/250

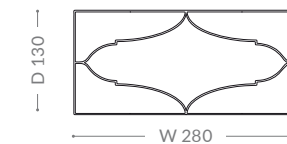
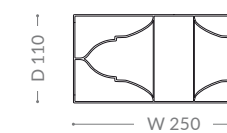
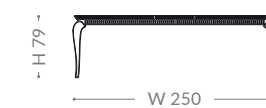

MANHATTAN
rectangular cm 280

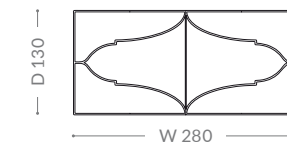

MANHATTAN
rectangular
extensible cm 280/330/380

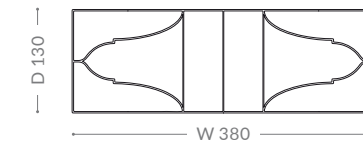
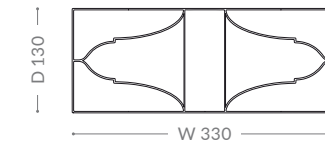

METROPOLIS

ELLIPTICAL DINING TABLE

Struttura in legno massello. Base unica in legno con decori in ottone. Piano disponibile in noce canaletto o ebano makassar, con decoro laccato.

Solid wood frame. Wooden single base with brass decoration. Top available in canaletto walnut or makassar ebony veneer, with lacquered decoration.

Каркас из массива дерева. Деревянная основа с одной ножкой и отделкой из латуни. Доступна столешница из шпона макассарского эбена или ореха каналетто с лаковой отделкой.

实木框架。黄铜装饰木制单底座。桌面可选涂漆装饰的望加锡乌木或卡纳莱托胡桃木饰面板。

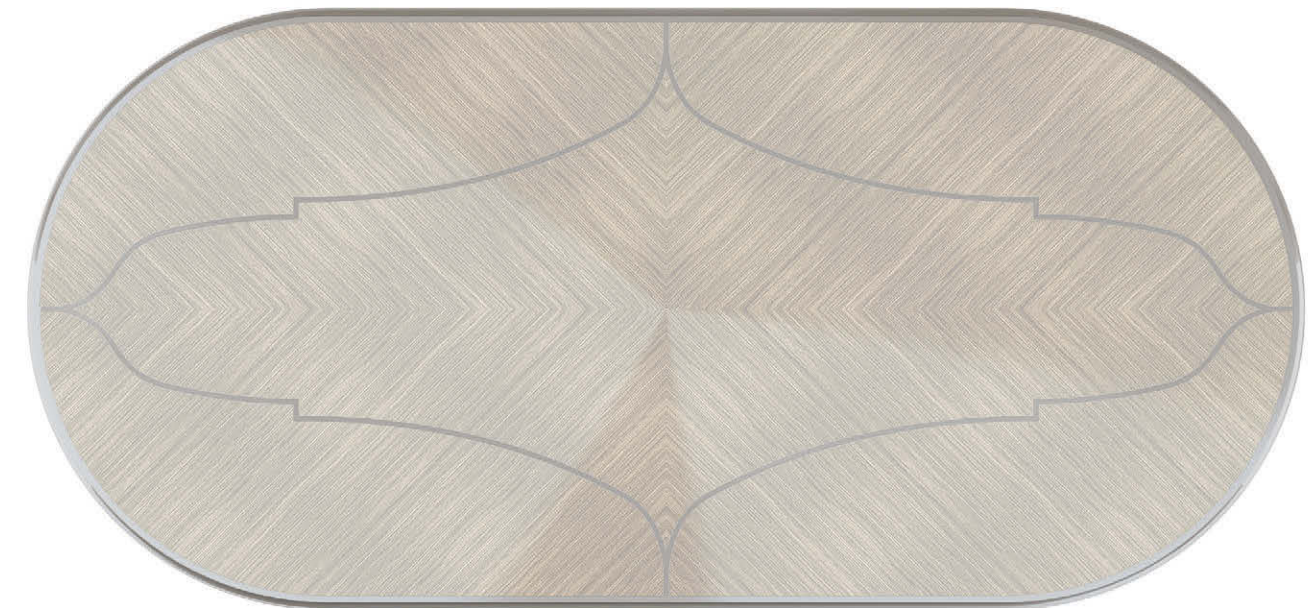
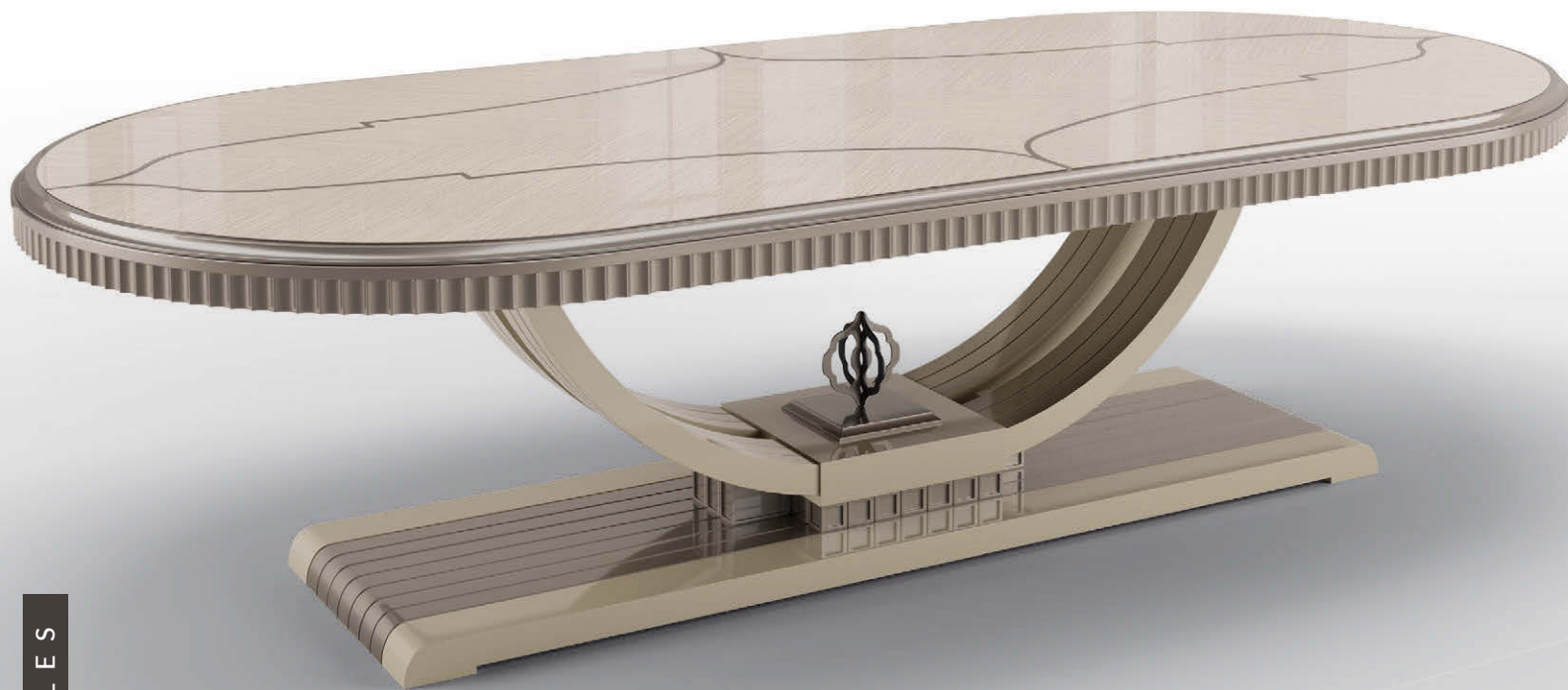

DINING TABLES

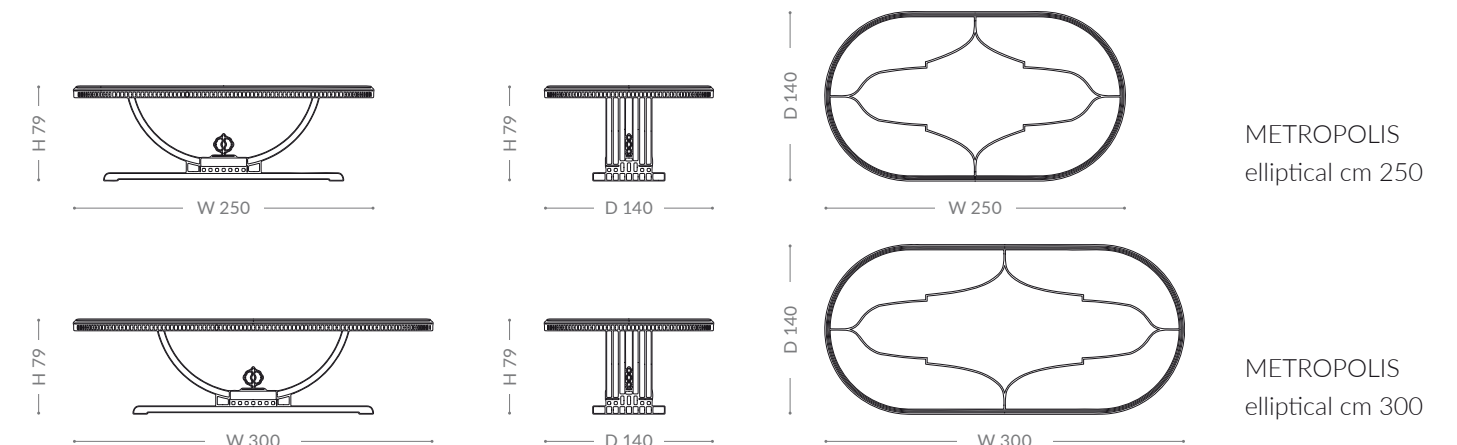

As picture: Metropolis elliptical dining table cm 300
In price list: Brilliant

Lucidatura/Finishing/Отделка/饰面
51. SAND
63. WHITENED CANALETTO WALNUT
88. DIAMOND TITANIUM

Parti in metallo/Metal parts/Металлическая фурнитура/金属部件
88. DIAMOND TITANIUM

METROPOLIS WIDE

ELLIPTICAL DINING TABLE

Struttura in legno massello. Due basi in legno con decori in ottone. Piano disponibile in noce canaletto o ebano makassar, con decoro laccato.

Solid wood frame. Two wooden bases with brass decoration. Top available in canaletto walnut or makassar ebony veneer, with lacquered decoration.

Каркас из массива дерева. Две деревянные основы с отделкой из латуни. Доступна столешница из шпона макассарского эбена или ореха каналетто с лаковой отделкой.

实木框架。黄铜装饰木制双底座。桌面可选涂漆装饰的望加锡乌木或卡纳莱托胡桃木饰面板。

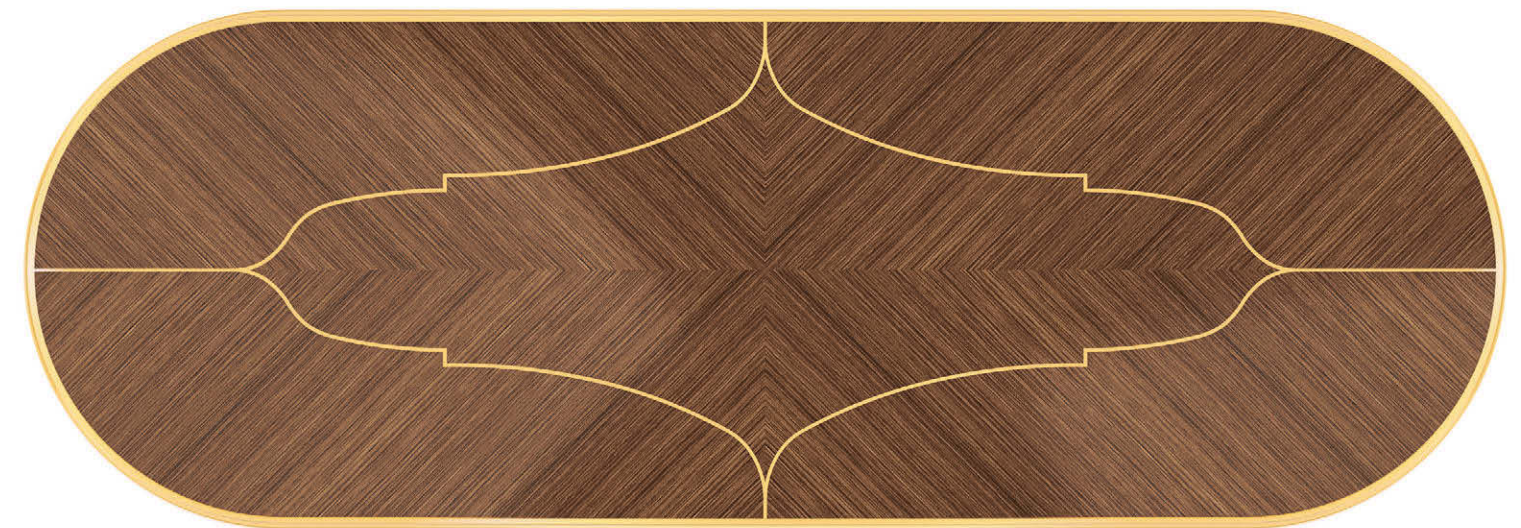
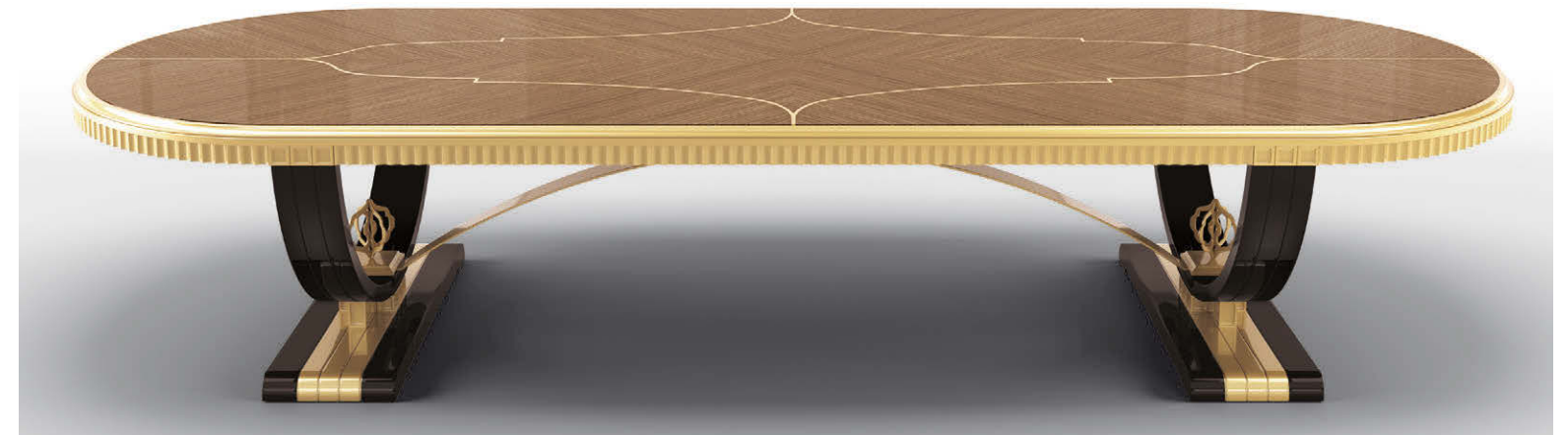

DINING TABLES

As picture: Metropolis Wide elliptical dining table cm 400
In price list: Brilliant

Lucidatura/Finishing/Отделка/饰面
57. CHOCOLATE
64. CANALETTO WALNUT
61. DIAMOND GOLD

Parti in metallo/Metal parts/Металлическая фурнитура/金属部件
61. DIAMOND GOLD

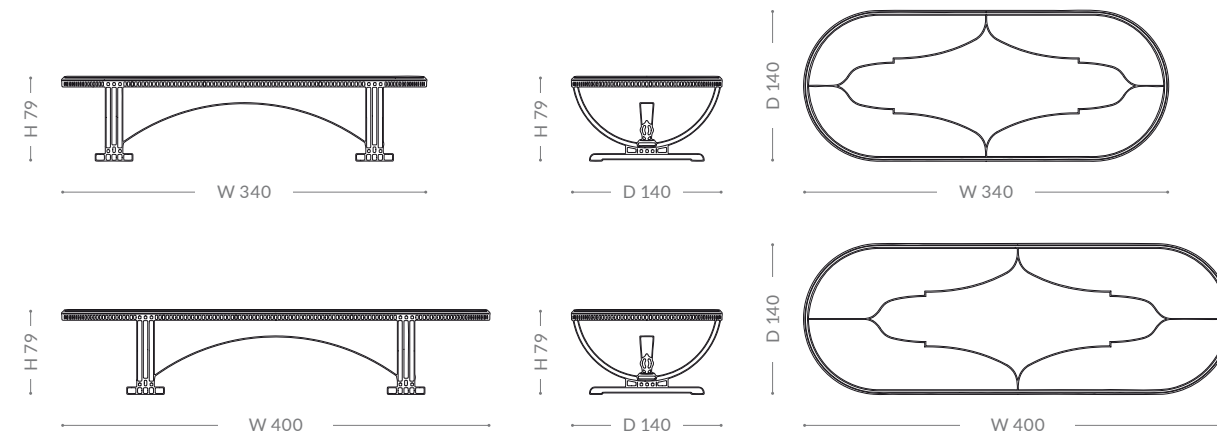

METROPOLIS WIDE elliptical cm 340

METROPOLIS WIDE elliptical cm 400

METROPOLIS

ROUND DINING TABLE

Struttura in legno massello. Base in legno con decori in ottone. Piano disponibile in noce canaletto o ebano makassar, con decorazione laccata. "Lazy Susan" su richiesta.

Solid wood frame. Wooden base with brass decoration. Top available in canaletto walnut or makassar ebony veneer, with lacquered decoration. "Lazy Susan" on request.

Каркас из массива дерева. Деревянная основа с отделкой из латуни. Доступна столешница из шпона макассарского эбена или ореха каналетто с лаковой отделкой. Вращающаяся подставка по запросу.

实木框架。黄铜装饰木制底座。桌面可选涂漆装饰的望加锡乌木或卡纳莱托胡桃木饰面板。可根据要求定制“餐桌转盘”。

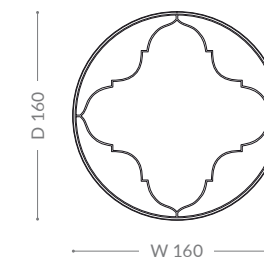
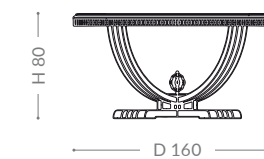
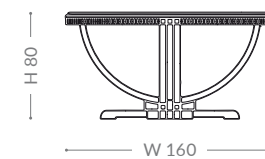

METROPOLIS round cm 160

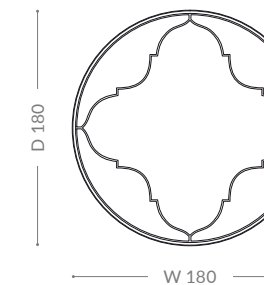
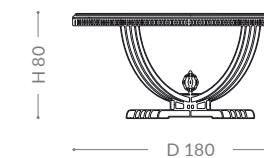
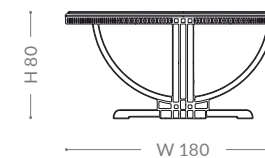

METROPOLIS round cm 180

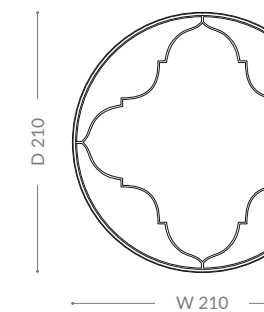
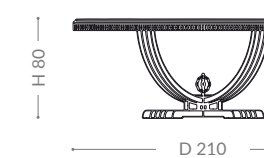
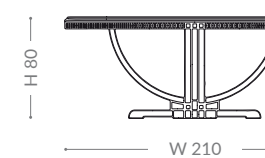

METROPOLIS round cm 210

As picture: Metropolis round dining table cm 180
In price list: Brilliant/Lazy Susan on request

Lucidatura/Finishing/Отделка/饰面
53. DOVE GREY
63. WHITENED CANALETTO WALNUT

Parti in metallo/Metal parts/Металлическая фурнитура/金属部件
53. DOVE GREY

MILLENIUM

ROUND DINING TABLE



Struttura in metallo e legno laccato. Base decorata in pelle ricamata. Piano disponibile in essenza di ebano makassar. "Lazy Susan" disponibile su richiesta.

Metal and lacquered wooden frame. Quilted leather base. Top available in makassar ebony veneer. "Lazy Susan" on request.

Каркас из металла и древесины. Стеганая кожаная основа. Столешница из шпона макассарского эбена. Вращающаяся подставка по запросу.

金属和漆木框架。绗缝皮革底座。望加锡乌木桌面饰面板。可根据要求定制“餐桌转盘”。

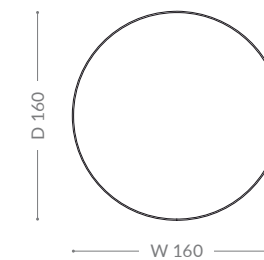
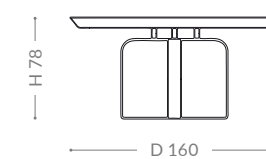
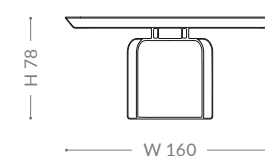

MILLENIUM round cm 160

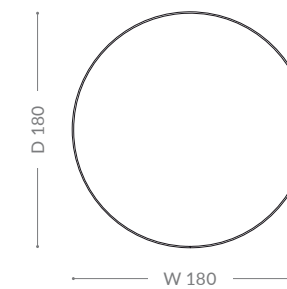
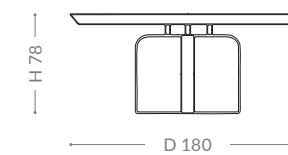
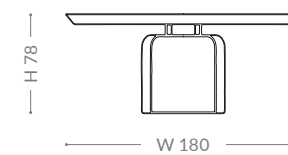

MILLENIUM round cm 180

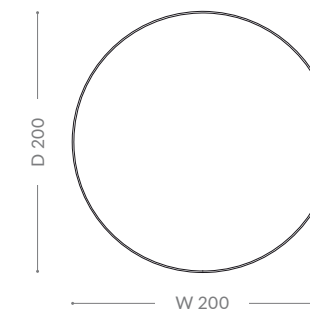
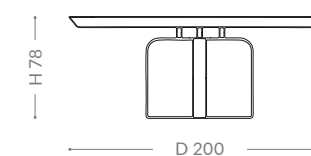
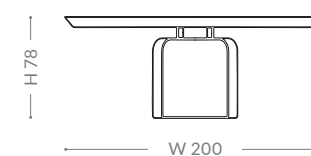

MILLENIUM round cm 200

DINING TABLES

As picture: Millemium round dining table cm 180
In price list: Brilliant/Lazy Susan on request

Lucidatura/Finishing/Отделка/饰面
57. CHOCOLATE
65. MAKASSAR

Parti in metallo/Metal parts/Металлическая фурнитура/金属部件
GOLD

Materiale/Material/Материал/材料
BZ 906-2030 LEATHER BURGUNDY

MILLENIUM

RECTANGULAR DINING TABLE

Struttura in metallo e legno laccato. Base decorata in pelle ricamata. Piano disponibile in essenza di ebano makassar.

Metal and lacquered wood frame. Quilted leather base. Top available in makassar ebony veneer.

Каркас из металла и лакированной древесины. Стеганая кожаная основа. Столешница из шпона макассарского эбена.

金属和漆木框架。绗缝皮革底座。桌面为望加锡乌木饰面。

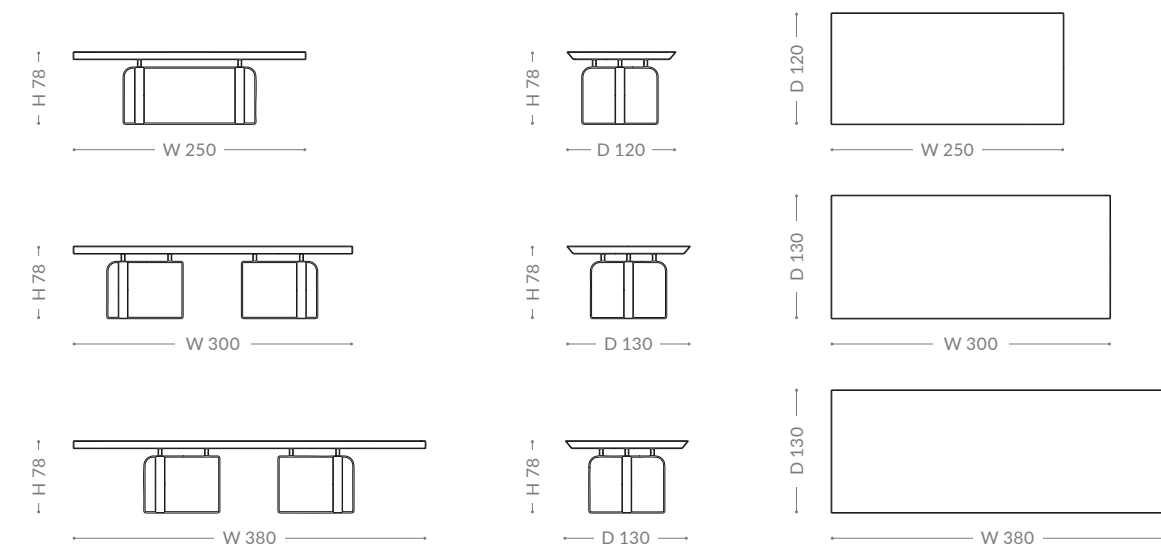
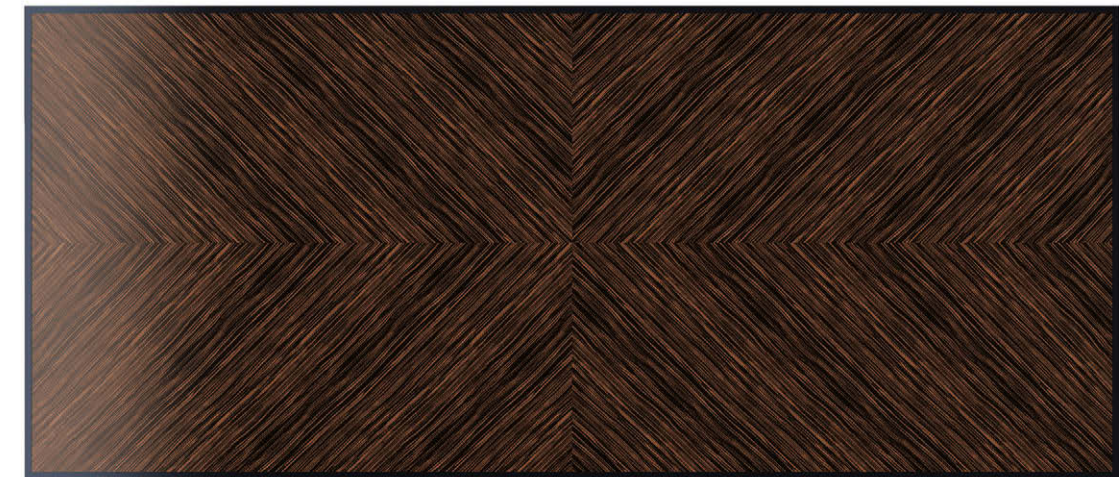

MILLENIUM rectangular cm 380

DINING TABLES

As picture: Millemium rectangular dining table cm 300
In price list: Brilliant

Lucidatura/Finishing/Отделка/饰面
57. CHOCOLATE
65. MAKASSAR

Parti in metallo/Metal parts/Металлическая фурнитура/金属部件
GOLD

Materiale/Material/Материал/材料
BZ 905-5234 LEATHER BEIGE

OMEGA

CRYSTAL RECTANGULAR DINING TABLE



Struttura in legno e metallo.
Base decorata in pelle
ricamata. Piano disponibile
in vetro color bronzo con
lavorazione a brillante sul
perimetro.

Metal and wooden frame.
Quilted leather base. Top
available in bronze glass with
diamond beveled edge.

Каркас из металла и
древесины. Стеганая
кожаная основа. Доступна
столешница из бронзового
стекла с факетированным
краем.

金属木制框架。绗缝皮革底
座。桌面可选用青铜色菱形斜
边玻璃。

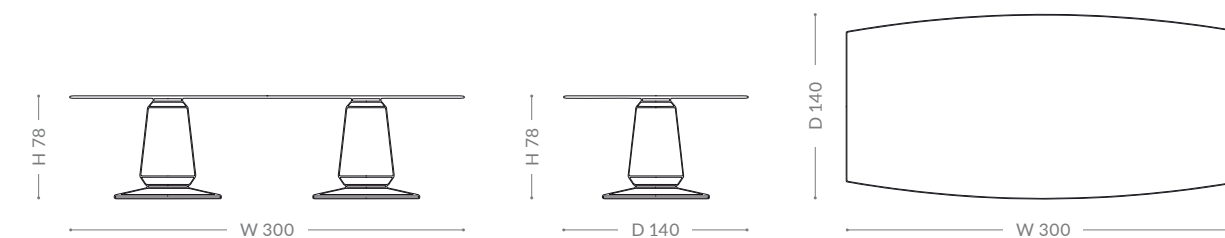

OMEGA
crystal rectangular cm 300

DINING TABLES

As picture: Omega crystal
rectangular dining table
In price list: Brilliant

Lucidatura/Finishing/Отделка/饰面
95. CARMEL

Parti in metallo/Metal parts/Метал-
лическая фурнитура/金属部件
GOLD

Materiale/Material/Материал/
材料
BZ 906-2023 LEATHER CARMEL

OMEGA

EBONY RECTANGULAR DINING TABLE



Struttura in legno e metallo.
Base decorata in pelle
ricamata. Piano disponibile in
essenza di ebano makassar.

Metal and wooden frame.
Quilted leather base. Top
available in makassar ebony
veneer.

Каркас из металла и
древесины. Стеганая
кожаная основа.
Столешница из шпона
макassarского эбена.

金属和木质框架。绗缝皮革底
座。桌面为望加锡乌木饰面。

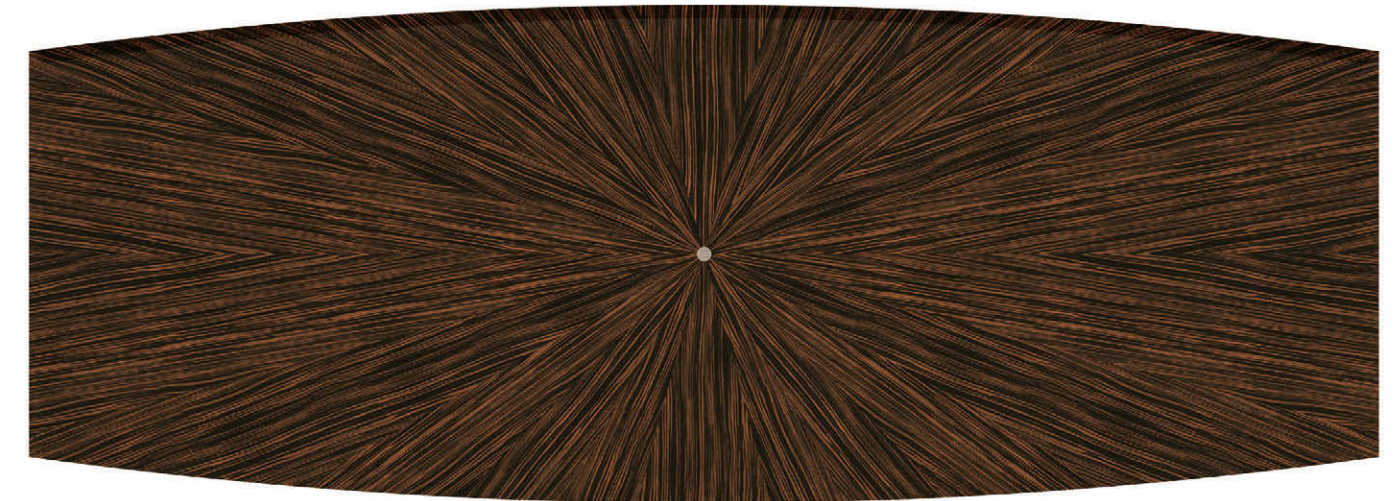

DINING TABLES

As picture: Omega ebony rec-
tangular dining table cm 380
In price list: Brilliant

Lucidatura/Finishing/Отделка/饰面
56. BROWN
65. MAKASSAR

Parti in metallo/Metal parts/Метал-
лическая фурнитура/金属部件
TITANIUM

Materiale/Material/Материал/
材料
BZ 906-2003 LEATHER DARK BROWN

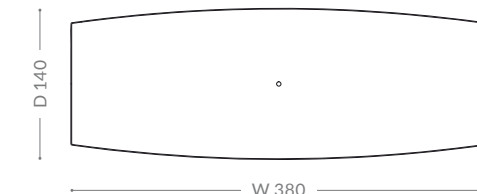
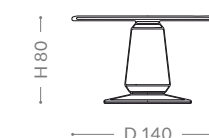
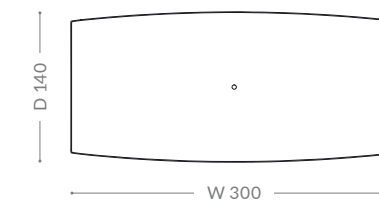
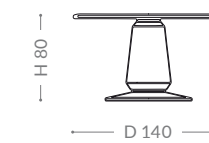
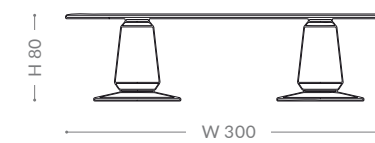

OMEGA
ebony rectangular cm 300

OMEGA
ebony rectangular cm 380

OMEGA

CRYSTAL ROUND DINING TABLE



Struttura in legno e metallo.
Base decorata in pelle
ricamata. Piano disponibile
in vetro color bronzo con
lavorazione a brillante sul
perimetro. "Lazy Susan"
disponibile su richiesta.

Metal and wooden frame.
Quilted leather base. Top
available in bronze glass with
diamond beveled edge.
"Lazy Susan" on request.

Каркас из металла и
древесины. Стеганая
кожаная основа. Доступна
столешница из бронзового
стекла с фацетированным
краем. Вращающаяся
подставка по запросу.

金属木制框架。绗缝皮革底
座。桌面可选用青铜色菱形斜
边玻璃。可根据要求定制“餐
桌转盘”。

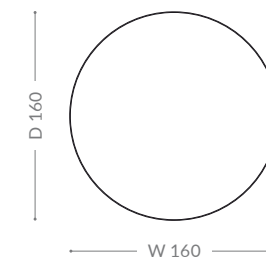
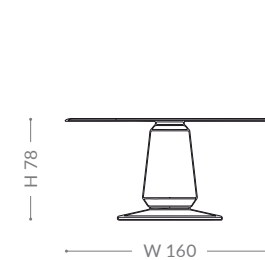

OMEGA
crystal round cm 160

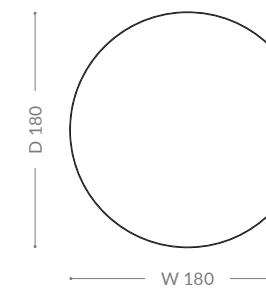
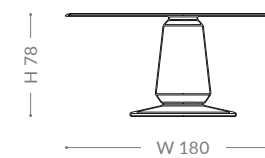

OMEGA
crystal round cm 180

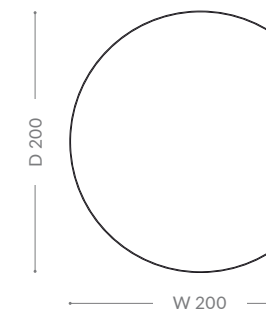

OMEGA
crystal round cm 200

DINING TABLES

As picture: Omega crystal
round dining table cm 180
In price list: Brilliant/Lazy
Susan on request

Lucidatura/Finishing/Отделка/饰面
57. CHOCOLATE
Lazy Susan
65. MAKASSAR

Parti in metallo/Metal parts/Метал-
лическая фурнитура/金属部件
GOLD

Materiale/Material/Материал/
材料
BZ 906-2030 LEATHER BURGUNDY

OMEGA

EBONY ROUND DINING TABLE



Struttura in legno e metallo. Base decorata in pelle ricamata. Piano disponibile in essenza di ebano makassar. "Lazy Susan" disponibile su richiesta.

Metal and wooden frame. Quilted leather base. Top available in makassar ebony veneer. "Lazy Susan" on request.

Каркас из металла и древесины. Стеганая кожаная основа. Столешница из шпона макаassarского эбена. Вращающаяся подставка по запросу.

金属和木质框架。绗缝皮革底座。桌面为望加锡乌木饰面板。可根据要求定制“餐桌转盘”。

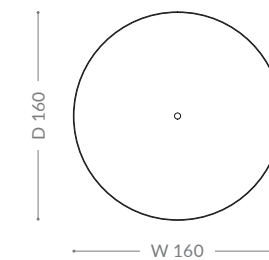
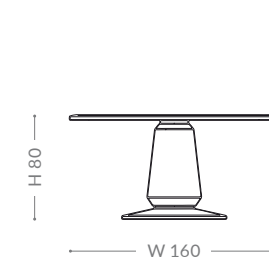
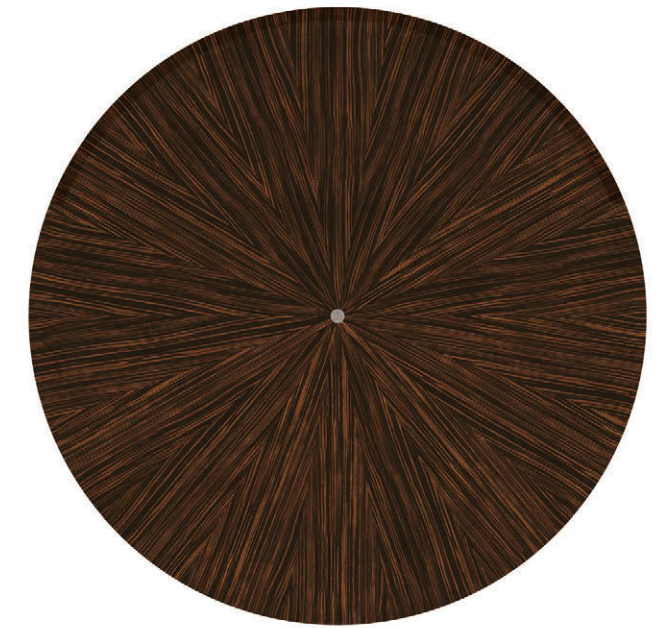

OMEGA
ebony round cm 160

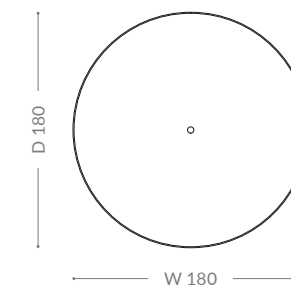
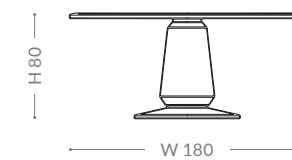

OMEGA
ebony round cm 180

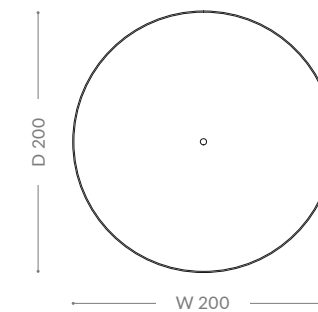
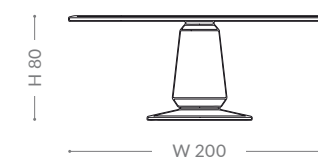

OMEGA
ebony round cm 200

DINING TABLES

As picture: Omega ebony round dining table cm 180
In price list: Brilliant/Lazy Susan on request

Lucidatura/Finishing/Отделка/饰面
65. MAKASSAR
54. GREY

Parti in metallo/Metal parts/Металлическая фурнитура/金属部件
TITANIUM

Materiale/Material/Материал/材料
BZ 906-2005 LEATHER OASI

ORION

ROUND DINING TABLE



Struttura in legno e metallo; gambe in noce canaletto. Piano disponibile in vetro spessore mm 15. "Lazy Susan" in legno laccato disponibile su richiesta.

Wooden and metal frame; canaletto walnut wooden legs. Glass top mm 15 thick. Lacquered wooden "Lazy Susan" on request.

Каркас из древесины и металла, деревянные ножки из ореха каналетто. Стекло-столешница толщиной 15 мм. Лакированная деревянная вращающаяся подставка по запросу.

木制金属框架；卡纳莱托胡桃木桌腿。15mm 玻璃桌面。可根据要求定制漆木“餐桌转盘”。

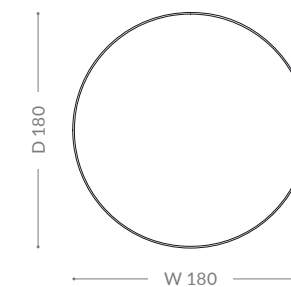
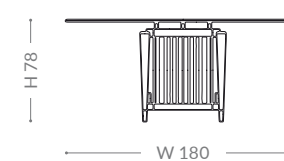

ORION
round cm 180

DINING TABLES

As picture: Orion round dining table
In price list: Brilliant/Lazy Susan on request

Lucidatura/Finishing/Отделка/饰面
54. GREY
Lazy Susan
69. CANALETTO WALNUT

Piano/Top/Столешница/桌面
EXTRA-WHITE GLASS

Parti in metallo/Metal parts/Металлическая фурнитура/金属部件
TITANIUM

ORION

RECTANGULAR DINING TABLE

Struttura in legno e metallo;
gambe in noce canaletto.
Piano disponibile in vetro
spessore mm 15.

Wooden and metal frame;
canaletto walnut wooden
legs. Glass top mm 15 thick
available.

Каркас из древесины и
металла, деревянные
ножки из ореха каналетто.
Стекло столешница
толщиной 15 мм.

木质和金属框架；卡纳莱托胡
桃木桌腿，15mm 厚玻璃桌
面。



DINING TABLES

As picture: Orion rectangu-
lar dining table cm 300
In price list: Brilliant

Lucidatura/Finishing/Отделка/饰面
69. CANALETTO WALNUT
51. SAND

Piano/Top/Столешница/桌面
EXTRA-WHITE GLASS

Parti in metallo/Metal parts/Метал-
лическая фурнитура/金属部件
GOLD

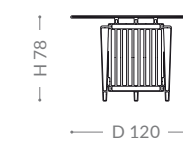
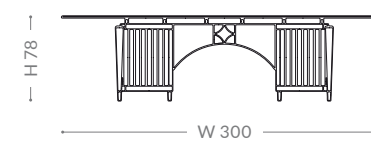

ORION
rectangular cm 300

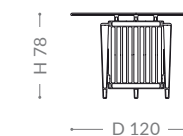
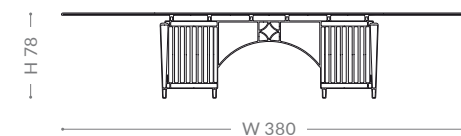

ORION
rectangular cm 380

PETRUS

RECTANGULAR DINING TABLE



Struttura e basamento in noce canaletto massello e metallo satinato. Piano disponibile in essenza di noce canaletto o marmo.

Satin metal and solid canaletto walnut frame and base. Top available in canaletto veneer or marble.

Каркас и основа из глянцевого металла и массива ореха каналетто. Доступна столешница из шпона ореха каналетто или из мрамора.

缎面金属及卡纳莱托胡桃木实木框架和底座。桌面可选用卡纳莱托胡桃木饰面板或大理石。

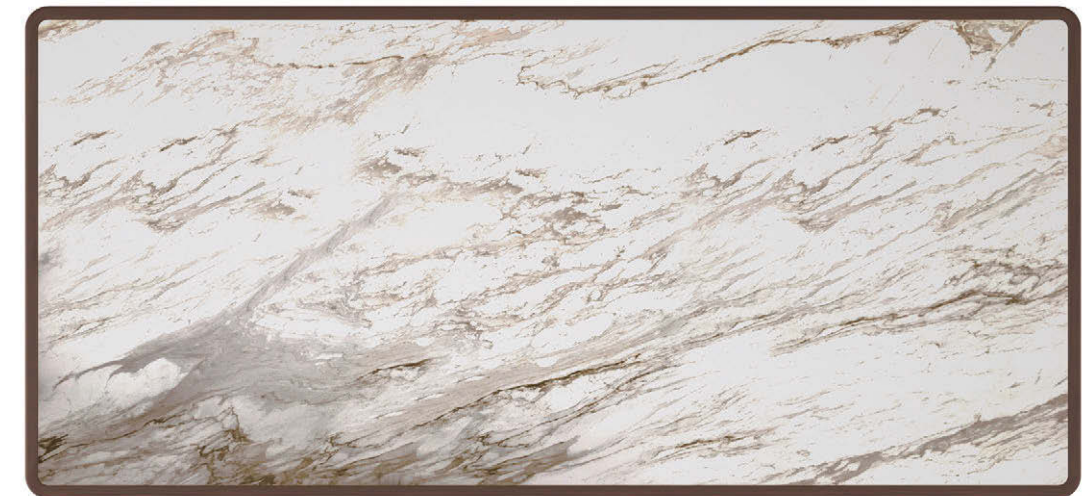

DINING TABLES

As picture: Petrus rectangular dining table cm 280
In price list: Prime/Precious stone

Lucidatura/Finishing/Отделка/饰面
93. WENGÉ MATT

Parti in metallo/Metal parts/Металлическая фурнитура/金属部件
SATIN GOLD

Marmo/Marble/Мрамор/大理石
CALACATTA CROMA-ARISTON

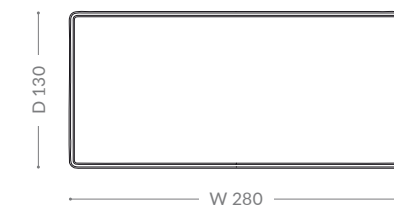
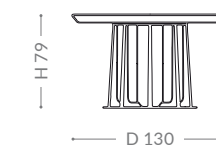
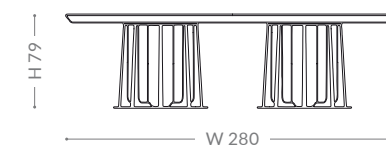

PETRUS
rectangular cm 280

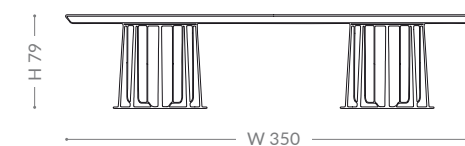

PETRUS
rectangular cm 350

PETRUS

ROUND DINING TABLE



Struttura e basamento in noce canaletto massello e metallo satinato. Piano disponibile in essenza di noce canaletto o marmo. "Lazy Susan" disponibile su richiesta.

Satin metal and solid canaletto walnut frame and base. Top available in canaletto walnut veneer or marble. "Lazy Susan" on request.

Каркас и основа из глянцевого металла и массива ореха каналетто. Доступна столешница из шпона ореха каналетто или из мрамора. Вращающаяся подставка по запросу.

缎面金属及卡纳莱托胡桃木实木框架和底座。桌面可选卡纳莱托胡桃木饰面板或大理石。可根据要求定制“餐桌转盘”。



As picture: Petrus round dining table cm 180
In price list: Brilliant/Lazy Susan on request

Lucidatura/Finishing/Отделка/饰面
69. CANALETTO WALNUT

Parti in metallo/Metal parts/Металлическая фурнитура/金属部件
SATIN GOLD

PETRUS

ROUND DINING TABLE

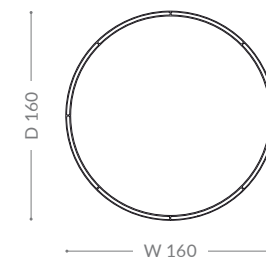
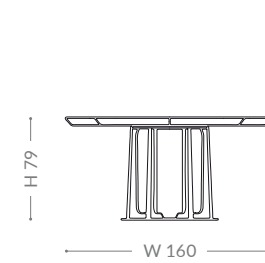

PETRUS
round cm 160

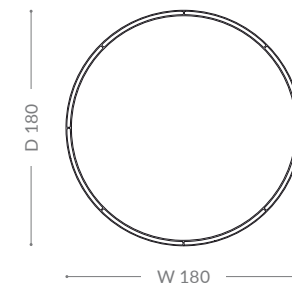
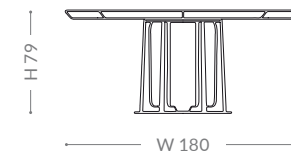

PETRUS
round cm 180

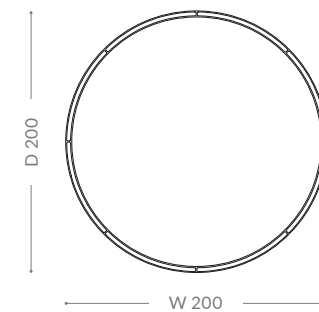
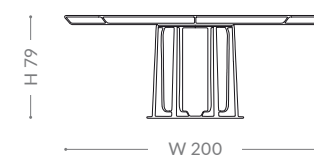

PETRUS
round cm 200

DINING TABLES

As picture: Petrus round dining table cm 200
In price list: Prime/Precious stone

Lucidatura/Finishing/Отделка/饰面
70. CANALETTO WALNUT MATT

Parti in metallo/Metal parts/Металлическая фурнитура/金属部件
SATIN TITANIUM

Marmo/Marble/Мрамор/大理石
MACAUBAS GIOTTO

WANDA

RECTANGULAR DINING TABLE

Struttura in metallo martellato e legno massello. Piano disponibile in essenza di noce canaletto. Disponibile con allunghe.

Hammered metal and solid wood frame. Top available in canaletto veneer. Available with length extensions.

Каркас из кованого металла и массива дерева. Доступна столешница из шпона ореха каналетто. Доступна с выдвигаемыми поверхностями.

锤制金属和实木框架。桌面可选用卡纳莱托胡桃木饰面板，可选延长桌面。

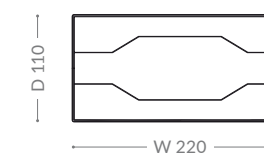
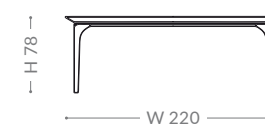
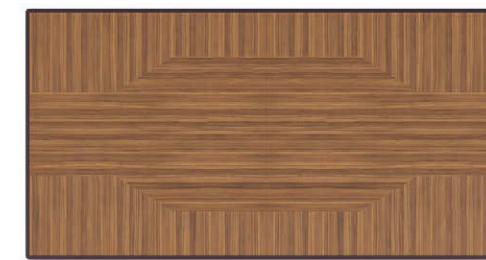

WANDA
rectangular cm 220

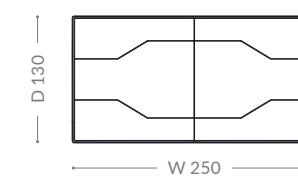
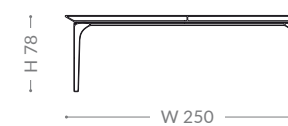

WANDA
rectangular extensible
cm 250/300/350

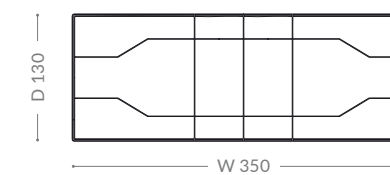
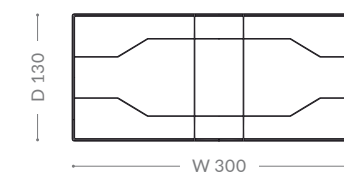
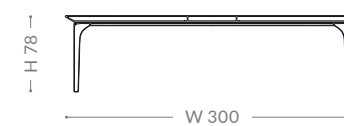

As picture: Wanda extensible rectangular dining table cm 250
In price list: Prime

Lucidatura/Finishing/Отделка/饰面
85. CHOCOLATE MATT
70. CANALETTO WALNUT MATT

Parti in metallo/Metal parts/Металлическая фурнитура/金属部件
HAMMERED GOLD

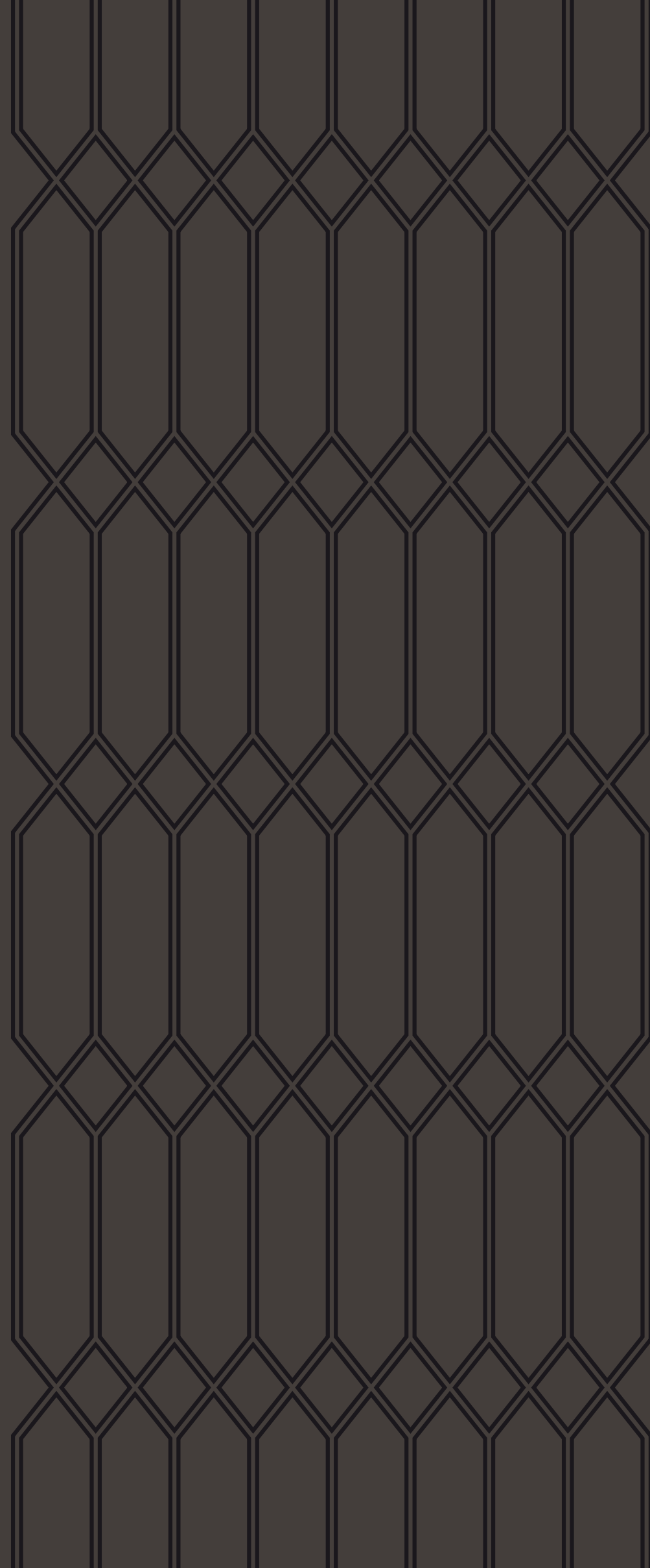

ZB

DINING CHAIRS



ARISTON

DINING CHAIR

DINING CHAIRS



As picture: Ariston dining chair
In price list: Ambition



Sedia/Chair/Стул/椅子
BZ 905-5234 LEATHER BEIGE

Parti in metallo/Metal parts/Металлическая фурнитура/金属部件
GOLD

Struttura in metallo; seduta e schienale in legno con imbottitura in poliuretano a quote differenziate. Parte esterna decorata con ricamo.

Metal frame; wooden backrest and seating, with multiple densities polyurethane foam padding.

Металлическая рама; деревянная спинка и сиденье с набивкой из пенополиуретана разной плотности. Стеганая внешняя часть корпуса.

金属框架; 木质靠背和座位, 内部填充多种密度的聚氨酯泡沫垫料。外侧部分绗缝。

ARISTON

DINING CHAIR



As picture: Ariston dining chair
In price list: Ambition

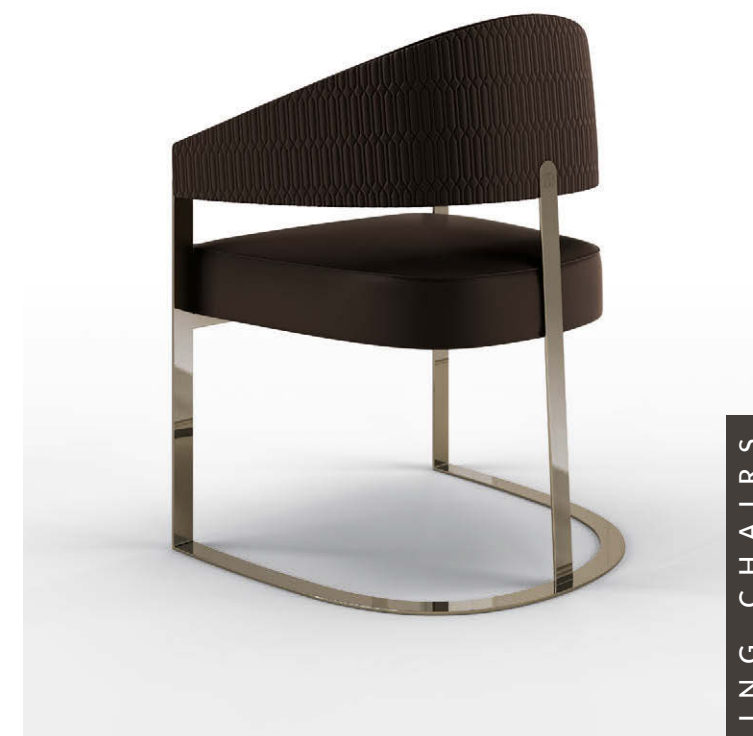

Sedia/Chair/Стул/椅子
BZ 906-2003 LEATHER DARK BROWN

Parti in metallo/Metal parts/Металлическая фурнитура/金属部件
TITANIUM

DINING CHAIRS

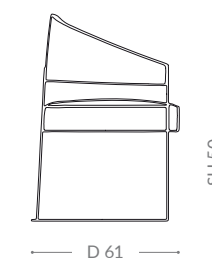
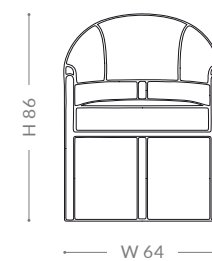

CAPRICE

DINING ARMCHAIR

DINING CHAIRS



As picture: Caprice dining armchair
In price list: Exclusive

Sedia/Chair/Стул/椅子
BZ 214-01 VELVET CARVED CARAMEL
BZ 906-2023 LEATHER CARAMEL



Lucidatura/Finishing/Отделка/饰面
85. CHOCOLATE MATT

Parti in metallo/Metal parts/Металлическая фурнитура/金属部件
GOLD

Struttura in legno massello e multistrati di legno. Guscio in pelle ricamata. Imbottitura in poliuretano a quote differenziate.

Solid wood and plywood frame. Quilted shell. Multiple densities polyurethane foam padding.

Рама из массива дерева и фанеры. Стеганая обшивка. Набивка из пенополиуретана разной плотности.

实木和胶合板框架。外部裱缝装饰。内部填充多种密度的聚氨酯泡沫垫料。

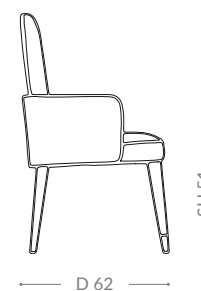
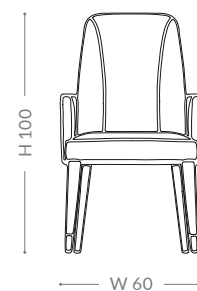

CAPRICE

DINING CHAIR



As picture: Caprice dining chair
In price list: Exclusive

Sedia/Chair/Стул/椅子
BZ 214-01 VELVET CARVED CARAMEL
BZ 906-2023 LEATHER CARAMEL



Lucidatura/Finishing/Отделка/饰面
85. CHOCOLATE MATT

Parti in metallo/Metal parts/Металлическая фурнитура/金属部件
GOLD

Struttura in legno massello e multistrati di legno. Guscio in pelle ricamata. Imbottitura in poliuretano a quote differenziate.

Solid wood and plywood frame. Quilted shell. Multiple densities polyurethane foam padding.

Рама из массива дерева и фанеры. Стеганая обшивка. Набивка из пенополиуретана разной плотности.

实木和胶合板框架。外部裱缝装饰。内部填充多种密度的聚氨酯泡沫垫料。

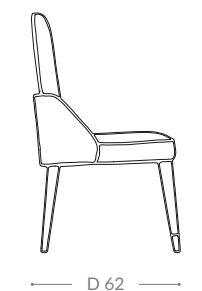
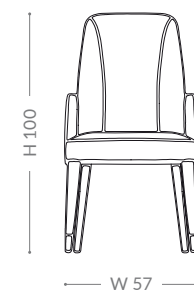

DINING CHAIRS

CELINE

DINING ARMCHAIR

DINING CHAIRS



As picture: Celine dining armchair
In price list: Ambition/Brilliant

Sedia/Chair/Стул/椅子
BZ 906-2005 LEATHER OASI



Lucidatura/Finishing/Отделка/饰面
57. CHOCOLATE

Parti in metallo/Metal parts/Металлическая фурнитура/金属部件
GOLD

Struttura in legno massello. Schienale e parte esterna ricamati. Imbottitura in poliuretano a quote differenziate.

Solid wood frame. Quilted backrest and outer body. Multiple densities polyurethane foam padding.

Рама из массива дерева. Стеганая спинка и внешняя часть каркаса. Набивка из пенополиуретана разной плотности.

实木框架。靠背和外部点缀绗缝装饰。内部填充多种密度的聚氨酯泡沫垫料。

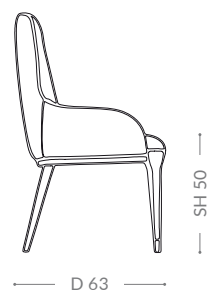
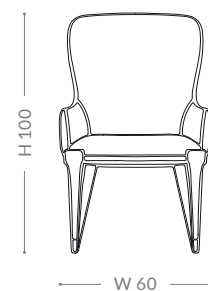

CELINE

DINING CHAIR



As picture: Celine dining chair
In price list: Ambition/Brilliant

Sedia/Chair/Стул/椅子
BZ 906-2005 LEATHER OASI



Lucidatura/Finishing/Отделка/饰面
57. CHOCOLATE

Parti in metallo/Metal parts/Металлическая фурнитура/金属部件
GOLD

Struttura in legno massello. Schienale e parte esterna ricamati. Imbottitura in poliuretano a quote differenziate.

Solid wood frame. Quilted backrest and outer body. Multiple densities polyurethane foam padding.

Рама из массива дерева. Стеганая спинка и внешняя часть каркаса. Набивка из пенополиуретана разной плотности.

实木框架。靠背和外部点缀绗缝装饰。内部填充多种密度的聚氨酯泡沫垫料。

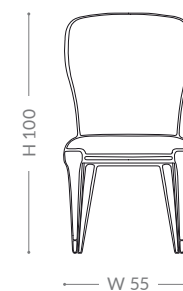

DINING CHAIRS

DILETTA

DINING ARMCHAIR

DINING CHAIRS



As picture: Diletta dining armchair
In price list: Ambition/Brilliant

Sedia/Chair/Стул/椅子
BZ 906-2005 LEATHER OASI



Lucidatura/Finishing/Отделка/饰面
54. GREY

Parti in metallo/Metal parts/Металлическая фурнитура/金属部件
GOLD

Struttura in legno massello e metallo. Gambe rivestite in pelle. Schienale sagomato con parte esterna e interna ricamati, finitura con borchie in pelle. Imbottitura in poliuretano a quote differenziate.

Solid wood and metal frame. Leather covered legs. Shaped backrest with quilted inner and outer body; finished with leather covered nails. Multiple densities polyurethane foam padding.

Рама из массива дерева и металла. Ножки, обтянутые кожей. Фигурная спинка со стеганой внутренней и передней частью каркаса; украшена декоративными гвоздями, обтянутыми кожей. Набивка из пенополиуретана разной плотности.

实木和金属框架。皮革椅腿。形状靠背，内外部均点缀缝装饰；饰面点缀皮革钉扣。内部填充多种密度的聚氨酯泡沫垫料。

DILETTA

DINING ARMCHAIR

DINING CHAIRS



As picture: Diletta dining armchair
In price list: Ambition/Brilliant

Sedia/Chair/Стул/椅子
BZ 906-2030 LEATHER BURGUNDY



Lucidatura/Finishing/Отделка/饰面
96. BURGUNDY

Parti in metallo/Metal parts/Металлическая фурнитура/金属部件
GOLD

DINING CHAIRS

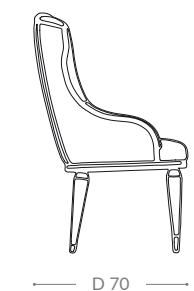
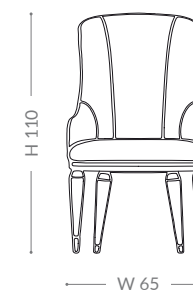

DILETTA

DINING CHAIR

DINING CHAIRS



As picture: Diletta dining chair
In price list: Ambition/Brilliant

Sedia/Chair/Стул/椅子
BZ 906-2030 LEATHER BURGUNDY

Lucidatura/Finishing/Отделка/饰面
96. BURGUNDY

Parti in metallo/Metal parts/Металлическая фурнитура/金属部件
GOLD

Struttura in legno massello e metallo. Gambe rivestite in pelle. Schienale sagomato con parte esterna e interna ricamati, finitura con borchie in pelle. Imbottitura in poliuretano a quote differenziate.

Solid wood and metal frame. Leather covered legs. Shaped backrest with quilted inner and outer body; finished with leather covered nails. Multiple densities polyurethane foam padding.

Рама из массива дерева и металла. Ножки, обтянутые кожей. Фигурная спинка со стеганой внутренней и передней частью каркаса; украшена декоративными гвоздями, обтянутыми кожей. Набивка из пенополиуретана разной плотности.

实木和金属框架。皮革椅腿。形状靠背，内外部均点缀缝线装饰；饰面点缀皮革钉扣。内部填充多种密度的聚氨酯泡沫垫料。

DILETTA

DINING CHAIR



As picture: Diletta dining chair
In price list: Ambition/Brilliant

Sedia/Chair/Стул/椅子
BZ 906-2005 LEATHER OASI

Lucidatura/Finishing/Отделка/饰面
54. GREY

Parti in metallo/Metal parts/Металлическая фурнитура/金属部件
GOLD

DINING CHAIRS

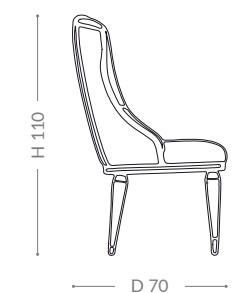

GRETA

DINING ARMCHAIR

DINING CHAIRS



As picture: Greta dining armchair
In price list: Prestige/Brilliant

Sedia/Chair/Стул/椅子
BZ 118-073 VELVET SAND
BZ 126-50 UNITO SAND/PEARL

Lucidatura/Finishing/Отделка/饰面
57. CHOCOLATE

Struttura in legno massello. Gambe, braccioli e schienale intagliati a mano; decorazione frontale e laterale in legno massello. Parte interna trapuntata a righe verticali. Imbottitura in poliuretano a quote differenziate.

Solid wood frame. Hand-carved legs, armrests and backrest; front and side solid wood decoration. Vertically decorated quilted inner body. Multiple densities polyurethane foam padding.

Рама из массива дерева. Ножки, подлокотники и спинка ручной работы; передняя и боковая отделка из массива дерева. Стеганая внутренняя часть каркаса с вертикальной отделкой. Набивка из пенополиуретана разной плотности.

实木框架。手工雕刻椅腿、扶手和靠背，正面和侧面点缀实木装饰。内里纵向褶皱装饰。内部填充多种密度的聚氨酯泡沫垫料。

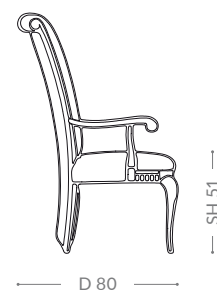
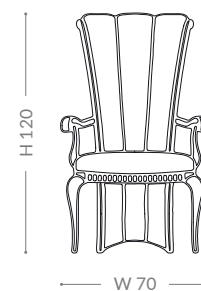

GRETA

DINING CHAIR



As picture: Greta dining chair
In price list: Prestige/Brilliant

Sedia/Chair/Стул/椅子
BZ 118-073 VELVET SAND
BZ 126-50 UNITO SAND/PEARL

Lucidatura/Finishing/Отделка/饰面
57. CHOCOLATE

Struttura in legno massello. Gambe e schienale intagliati a mano; decorazione frontale e laterale in legno massello. Parte interna trapuntata a righe verticali. Imbottitura in poliuretano a quote differenziate.

Solid wood frame. Hand-carved legs and backrest; front and side solid wood decoration. Vertically decorated quilted inner body. Multiple densities polyurethane foam padding.

Рама из массива дерева. Ножки и спинка ручной работы; передняя и боковая отделка из массива дерева. Стеганая внутренняя часть каркаса с вертикальной отделкой. Набивка из пенополиуретана разной плотности.

实木框架。手工雕刻椅腿和靠背，正面和侧面点缀实木装饰。内里纵向褶皱装饰。内部填充多种密度的聚氨酯泡沫垫料。

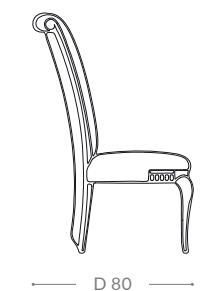
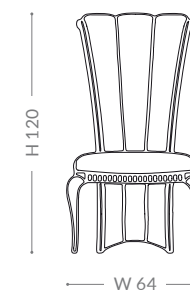

DINING CHAIRS

MARYBELL

DINING ARMCHAIR

DINING CHAIRS



As picture: Marybell dining armchair
In price list: Prestige



Sedia/Chair/Стул/椅子
BZ 191-004 JACQUARD BLUE

Lucidatura/Finishing/Отделка/饰面
70. CANALETTO WALNUT MATT

Struttura in noce canaletto massello sagomato. Decorazione *plissé* su parte esterna. Imbottitura in poliuretano a quote differenziate.

Solid canaletto walnut wooden frame. *Plissé* decoration outer body. Multiple densities polyurethane foam padding.

Рама из массива дерева цвета ореха каналетто. Внешняя часть каркаса с отделкой *плиссе*. Набивка из пенополиуретана разной плотности.

卡纳莱托胡桃木实木框架。外部褶皱装饰。内部填充多种密度的聚氨酯泡沫垫料。

MARYBELL

DINING ARMCHAIR



As picture: Marybell dining armchair
In price list: Brilliant

Sedia/Chair/Стул/椅子
BZ 217-101 VELVET DOVE GREY



Lucidatura/Finishing/Отделка/饰面
69. CANALETTO WALNUT

DINING CHAIRS

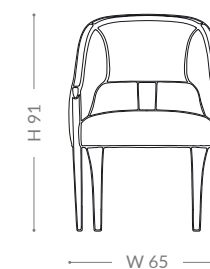

OPHELIA

DINING ARMCHAIR

DINING CHAIRS



As picture: Ophelia dining armchair
In price list: Ambition/Brilliant

Sedia/Chair/Стул/椅子
BZ 901-332 LEATHER BUTTER

Lucidatura/Finishing/Отделка/饰面
50. IVORY

Parti in metallo/Metal parts/Металлическая фурнитура/金属部件
GOLD



Struttura in legno massello. Gambe frontali in legno di faggio con decorazioni in ottone. Parte interna ricamata; schienale con decorazione a corsetto. Imbottitura in poliuretano a quote differenziate.

Solid wood frame. Beechwood front legs with brass decoration. Quilted inner body; outer body with corset decoration. Multiple densities polyurethane foam padding.

Рама из массива дерева. Передние ножки из бука с латунной отделкой. Стеганая внутренняя часть каркаса; отделка «корсет» внешнего каркаса. Набивка из пенополиуретана разной плотности.

实木框架。山毛榉质地前腿点缀黄铜装饰内里绗缝装饰，外部交叉系带装饰。内部填充多种密度的聚氨酯泡沫垫料。

OPHELIA

DINING ARMCHAIR



As picture: Ophelia dining armchair
In price list: Ambition

Sedia/Chair/Стул/椅子
BZ 905-5141 LEATHER DARK GREY

Lucidatura/Finishing/Отделка/饰面
86. BLACK MATT

Parti in metallo/Metal parts/Металлическая фурнитура/金属部件
CROMO



DINING CHAIRS

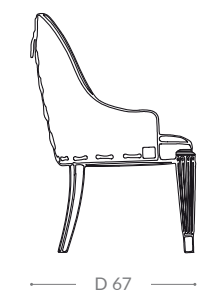
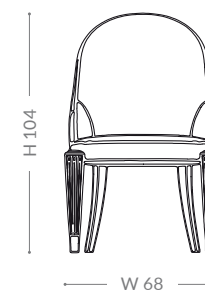

OPHELIA

DINING CHAIR

DINING CHAIRS



As picture: Ophelia dining chair
In price list: Ambition

Sedia/Chair/Стул/椅子
BZ 905-5141 LEATHER DARK GREY



Lucidatura/Finishing/Отделка/饰面
86. BLACK MATT

Parti in metallo/Metal parts/Металлическая фурнитура/金属部件
CROMO

Struttura in legno massello. Gambe frontali in legno di faggio con decorazioni in ottone. Parte interna ricamata; schienale con decorazione a corsetto. Imbottitura in poliuretano a quote differenziate.

Solid wood frame. Beechwood front legs with brass decoration. Quilted inner body; outer body with corset decoration. Multiple densities polyurethane foam padding.

Рама из массива дерева. Передние ножки из бука с латунной отделкой. Стеганая внутренняя часть каркаса; отделка «корсет» внешнего каркаса. Набивка из пенополиуретана разной плотности.

实木框架。山毛榉质地前腿点缀黄铜装饰内里绗缝装饰，外部交叉系带装饰。内部填充多种密度的聚氨酯泡沫垫料。

OPHELIA

DINING CHAIR



As picture: Ophelia dining chair
In price list: Ambition/Brilliant

Sedia/Chair/Стул/椅子
BZ 901-335 LEATHER RED



Lucidatura/Finishing/Отделка/饰面
57. CHOCOLATE

Parti in metallo/Metal parts/Металлическая фурнитура/金属部件
GOLD

DINING CHAIRS

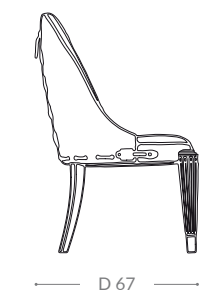
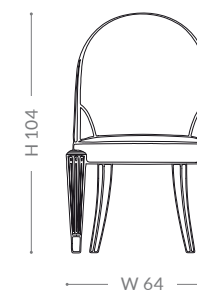

OPIUM

DINING ARMCHAIR

DINING CHAIRS



As picture: Opium dining armchair
In price list: Ambition/Brilliant

Sedia/Chair/Стул/椅子
BZ 901-622 LEATHER BEIGE

Lucidatura/Finishing/Отделка/饰面
57. CHOCOLATE
65. MAKASSAR

Parti in metallo/Metal parts/Металлическая фурнитура/金属部件
GOLD

Struttura in legno massello e multistrati di legno. Inserto ricamato su schiena e seduta. Imbottiture in poliuretano a quote differenziate. Disponibile in essenza di ebano makassar.

Solid wood and plywood frame. Quilted backrest and seating. Multiple densities polyurethane foam padding. Available in makassar ebony veneer.

Рама из массива дерева и фанеры. Стеганая спинка и сиденье. Набивка из пенополиуретана разной плотности. Доступный материал: шпон макассарского эбена.

实木和胶合板框架。座椅面和靠背衍缝装饰。内部填充多种密度的聚氨酯泡沫垫料。孟加锡乌木饰板面。

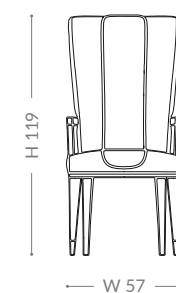

OPIUM

DINING CHAIR

DINING CHAIRS



As picture: Opium dining chair
In price list: Ambition/Brilliant

Sedia/Chair/Стул/椅子
BZ 901-622 LEATHER BEIGE

Lucidatura/Finishing/Отделка/饰面
57. CHOCOLATE
65. MAKASSAR

Parti in metallo/Metal parts/Металлическая фурнитура/金属部件
GOLD

Struttura in legno massello e multistrati di legno. Inserto ricamato su schiena e seduta. Imbottiture in poliuretano a quote differenziate. Disponibile in essenza di ebano makassar.

Solid wood and plywood frame. Quilted backrest and seating. Multiple densities polyurethane foam padding. Available in makassar ebony veneer.

Рама из массива дерева и фанеры. Стеганая спинка и сиденье. Набивка из пенополиуретана разной плотности. Доступный материал: шпон макассарского эбена.

实木和胶合板框架。座椅面和靠背衍缝装饰。内部填充多种密度的聚氨酯泡沫垫料。孟加锡乌木饰板面。

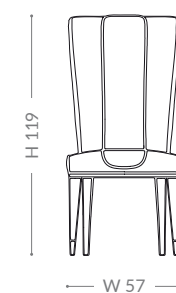

SUNRISE

DINING ARMCHAIR

DINING CHAIRS



As picture: Sunrise dining armchair
In price list: Ambition

Sedia/Chair/Стул/椅子
BZ 906-2005 LEATHER OASI

Lucidatura/Finishing/Отделка/饰面
70. CANALETTO WALNUT MATT
85. CHOCOLATE MATT

Struttura in legno massello. Gambe frontali in noce canaletto. Schienale e seduta decorata con ricamo. Imbottitura in poliuretano a quote differenziate.

Solid wood frame. Canaletto walnut wooden front legs. Quilted backrest and seating. Multiple densities polyurethane foam padding.

Рама из массива дерева. Деревянные передние ножки цвета ореха каналетто. Стеганая спинка и сиденье. Набивка из пенополиуретана разной плотности.

实木框架。前腿为卡纳莱托胡桃木。座椅面和靠背衍缝装饰。内部填充多种密度的聚氨酯泡沫垫料。

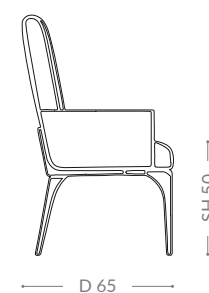
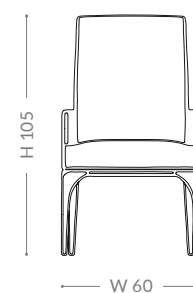

SUNRISE

DINING CHAIR

DINING CHAIRS



As picture: Sunrise dining chair
In price list: Ambition

Sedia/Chair/Стул/椅子
BZ 906-2005 LEATHER OASI

Lucidatura/Finishing/Отделка/饰面
70. CANALETTO WALNUT MATT
85. CHOCOLATE MATT

Struttura in legno massello. Gambe frontali in noce canaletto. Schienale e seduta decorata con ricamo. Imbottitura in poliuretano a quote differenziate.

Solid wood frame. Canaletto walnut wooden front legs. Quilted backrest and seating. Multiple densities polyurethane foam padding.

Рама из массива дерева. Деревянные передние ножки цвета ореха каналетто. Стеганая спинка и сиденье. Набивка из пенополиуретана разной плотности.

实木框架。前腿为卡纳莱托胡桃木。座椅面和靠背衍缝装饰。内部填充多种密度的聚氨酯泡沫垫料。

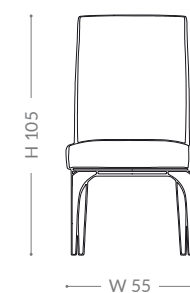

VERSAILLE

DINING ARMCHAIR

DINING CHAIRS



As picture: Versailles dining armchair
In price list: Prestige/Brilliant

Sedia/Chair/Стул/椅子
BZ 906-2006 LEATHER TAUPE
BZ 215-05 JACQUARD SANDSTONE

Lucidatura/Finishing/Отделка/饰面
54. GREY

Struttura in legno massello.
Parte esterna in pelle ricamata.
Imbottiture in poliuretano a
quote differenziate.

Solid wood frame. Quilted
leather outer body. Multiple
densities polyurethane foam
padding.

Рама из массива дерева.
Внешняя часть каркаса из
стеганой кожи. Набивка из
пенополиуретана разной
плотности.

实木框架。外部为衿缝皮革。
内部填充多种密度的聚氨酯泡
沫垫料。

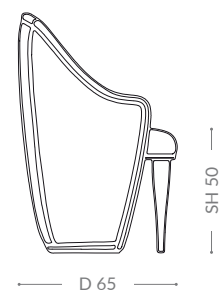
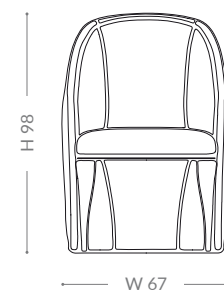

VERSAILLE

DINING CHAIR



DINING CHAIRS

As picture: Versailles dining chair
In price list: Prestige/Brilliant

Sedia/Chair/Стул/椅子
BZ 906-2006 LEATHER TAUPE
BZ 215-05 JACQUARD SANDSTONE

Lucidatura/Finishing/Отделка/饰面
54. GREY

Struttura in legno massello.
Parte esterna in pelle ricamata.
Imbottiture in poliuretano a
quote differenziate.

Solid wood frame. Quilted
leather outer body. Multiple
densities polyurethane foam
padding.

Рама из массива дерева.
Внешняя часть каркаса из
стеганой кожи. Набивка из
пенополиуретана разной
плотности.

实木框架。外部为衿缝皮革。
内部填充多种密度的聚氨酯泡
沫垫料。

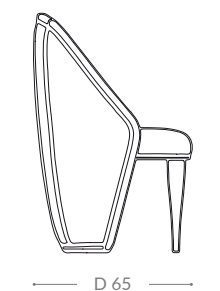
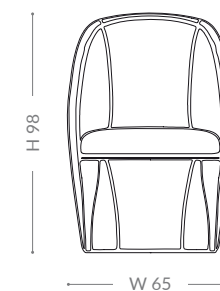

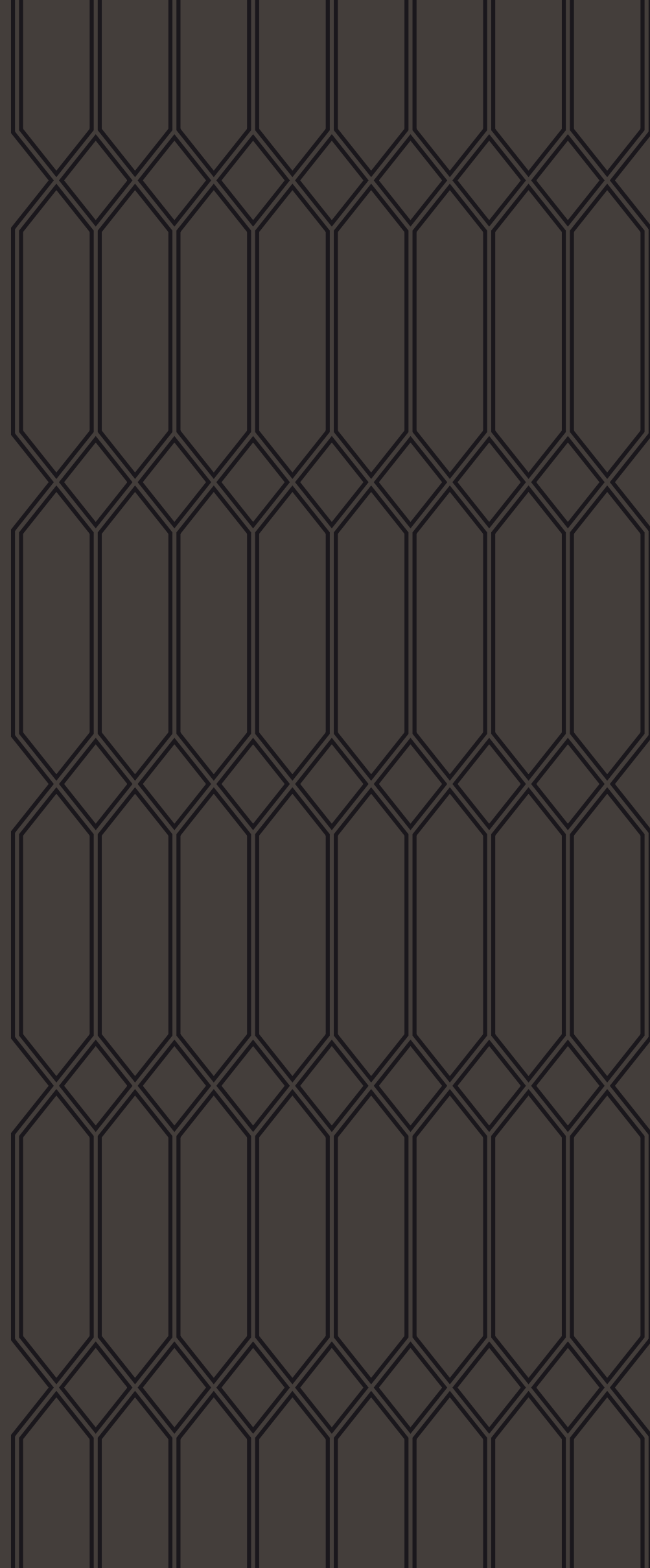

ZB

BAR COUNTERS
AND STOOLS



DIONISO

BAR COUNTER



Struttura in multistrati di legno e MDF. Decorazione frontale con profili di metallo e specchio. Illuminazione LED.

Plywood and MDF wooden frame. Mirror and metal vertical rods. LED lighting.

Деревянная рама из МДФ и фанеры. Зеркальные и металлические вертикальные панели. Светодиодное освещение.

胶合板和中密度纤维板木制框架。镜面和金属纵向装饰柱。LED 照明。

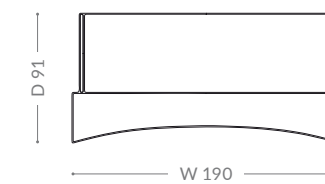
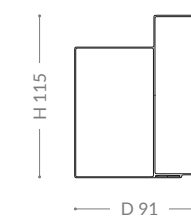
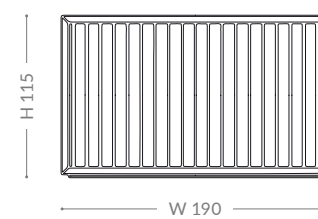

BAR COUNTERS

As picture: Dioniso bar counter
In price list: Prime

Lucidatura/Finishing/Отделка/饰面
86. BLACK MATT

Parti in metallo/Metal parts/Металлическая фурнитура/金属部件
TITANIUM

Decorazione/Decoration/Декоративный элемент/装饰
MIRROR EXTRA WHITE

LEGEND

BAR COUNTER

Struttura in multistrati di legno e MDF. Piano in marmo. Decorazione frontale in pelle ricamata. Colonne decorative in legno e metallo. Illuminazione LED.

Plywood and MDF wooden frame. Marble top. Frontal leather quilted decoration. Metal and wooden decorative columns. LED lighting.

Деревянная рама из МДФ и фанеры. Мраморная столешница. Передняя отделка из стеганой кожи. Металлические и деревянные декоративные колонны. Светодиодное освещение.

胶合板和中密度纤维板木制框架。大理石台面。正面点缀绗缝装饰。金属和实木装饰柱。LED 照明。



BAR COUNTERS

As picture: Legend bar counter
In price list: Brilliant/Precious stone

Lucidatura/Finishing/Отделка/饰面
57. CHOCOLATE

Parti in metallo/Metal parts/Металлическая фурнитура/金属部件
GOLD

Marmo/Marble/Мрамор/大理石
EMPERADOR LIGHT
Materiale/Material/Материал/材料
BZ 904-4632 LEATHER SAND

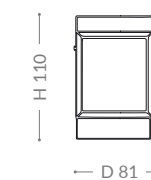

ARISTON

BAR STOOL

STOOLS



As picture: Ariston bar stool
In price list: Ambition

Sgabello bar/Bar stool/Барный стул/吧椅
BZ 905-5234 LEATHER BEIGE

Parti in metallo/Metal parts/Металлическая фурнитура/金属部件
GOLD

Struttura in metallo; seduta e schienale in legno con imbottitura in poliuretano a quote differenziate. Parte esterna decorata con ricamo.

Metal frame; wooden backrest and seating, with multiple densities polyurethane foam padding. Quilted outer body.

Металлическая рама; деревянная спинка и сиденье с набивкой из пенополиуретана разной плотности. Стеганая внешняя часть корпуса.

金属框架; 木质靠背和座位, 内部填充多种密度的聚氨酯泡沫垫料。外侧部分绗缝。

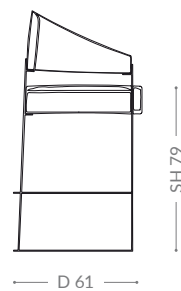
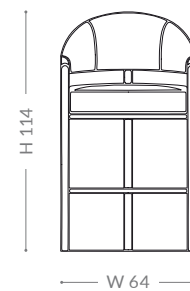

FLOWER

BAR STOOL

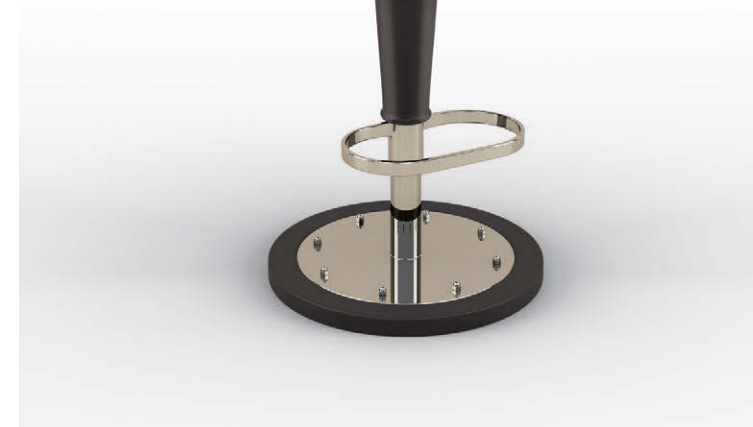

STOOLS

As picture: Flower bar stool
In price list: Ambition

Sgabello bar/Bar stool/Барный стул/吧椅
BZ 905-5141 LEATHER DARK GREY

Lucidatura/Finishing/Отделка/饰面
86. BLACK MATT

Parti in metallo/Metal parts/Металлическая фурнитура/金属部件
TITANIUM

Struttura in legno massello. Base centrale in metallo e legno di faggio. Seduta e schienale con decorazione a fasce trapuntate. Imbottitura in poliuretano a quote differenziate.

Solid wood frame. Metal and beechwood central base. Seating and backrest decorated with vertical piping. Multiple densities polyurethane foam padding.

Рама из массива дерева. Основа из металла и бука. Сиденье и спинка украшены вертикальной окантовкой. Набивка из пенополиуретана разной плотности.

实木框架。金属和山毛榉中央底座。座位和靠背点缀纵向滚边。内部填充多种密度的聚氨酯泡沫垫料。

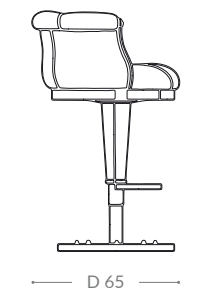
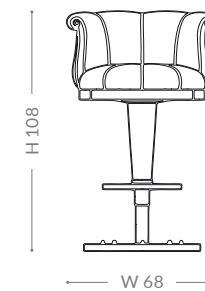

OPHELIA

BAR STOOL

S
T
O
O
L
S



As picture: Ophelia bar stool
In price list: Ambition/
Brilliant

Sgabello bar/Bar stool/Барный
стул/吧椅
BZ 904-4632 LEATHER SAND



Lucidatura/Finishing/Отделка/饰面
57. CHOCOLATE

Parti in metallo/Metal parts/Метал-
лическая фурнитура/金属部件
GOLD

Struttura in legno massello.
Base centrale in metallo
e legno di faggio con
decorazioni in ottone. Parte
interna ricamata; schienale
con decorazione a corsetto.
Imbottitura in poliuretano a
quote differenziate.

Solid wood frame. Metal and
beechwood central base with
brass decoration. Quilted
inner body; outer body corset
decoration. Multiple densities
polyurethane foam padding.

Рама из массива дерева.
Основа из металла и бука
с латунной отделкой.
Стеганая внутренняя часть
каркаса; отделка «корсет»
внешнего каркаса. Набивка
из пенополиуретана разной
плотности.

实木框架。金属和山毛榉中央
底座，饰以黄铜装饰。内里褶
缝装饰，外部交叉系带装饰。
内部填充多种密度的聚氨酯泡
沫垫料。

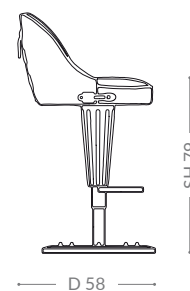
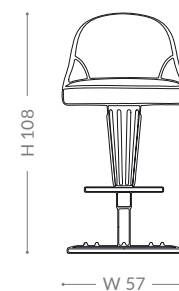

OPHELIA

BAR TABLE



As picture: Ophelia bar table
In price list: Brilliant

Lucidatura/Finishing/Отделка/饰面
57. CHOCOLATE
65. MAKASSAR

Parti in metallo/Metal parts/Метал-
лическая фурнитура/金属部件
GOLD



B
A
R
T
A
B
L
E

Struttura in metallo e legno
con decorazioni in ottone.
Piano disponibile in legno
laccato, noce canaletto e
ebano makassar.

Metal and wood frame with
brass decoration. Top available
in lacquered wood, canaletto
walnut or makassar ebony.

Рама из металла и древесины с
латунной отделкой. Доступно
сиденье из следующих
материалов: лакированная
древесина, орех каналетто или
макassarский эбен.

金属和实木框架，饰以黄铜装
饰。台面质地可选漆木、卡纳
莱托核桃木或孟加锡乌木。

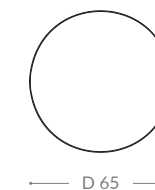
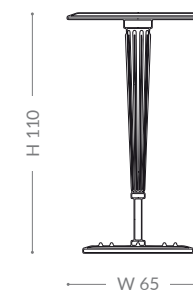

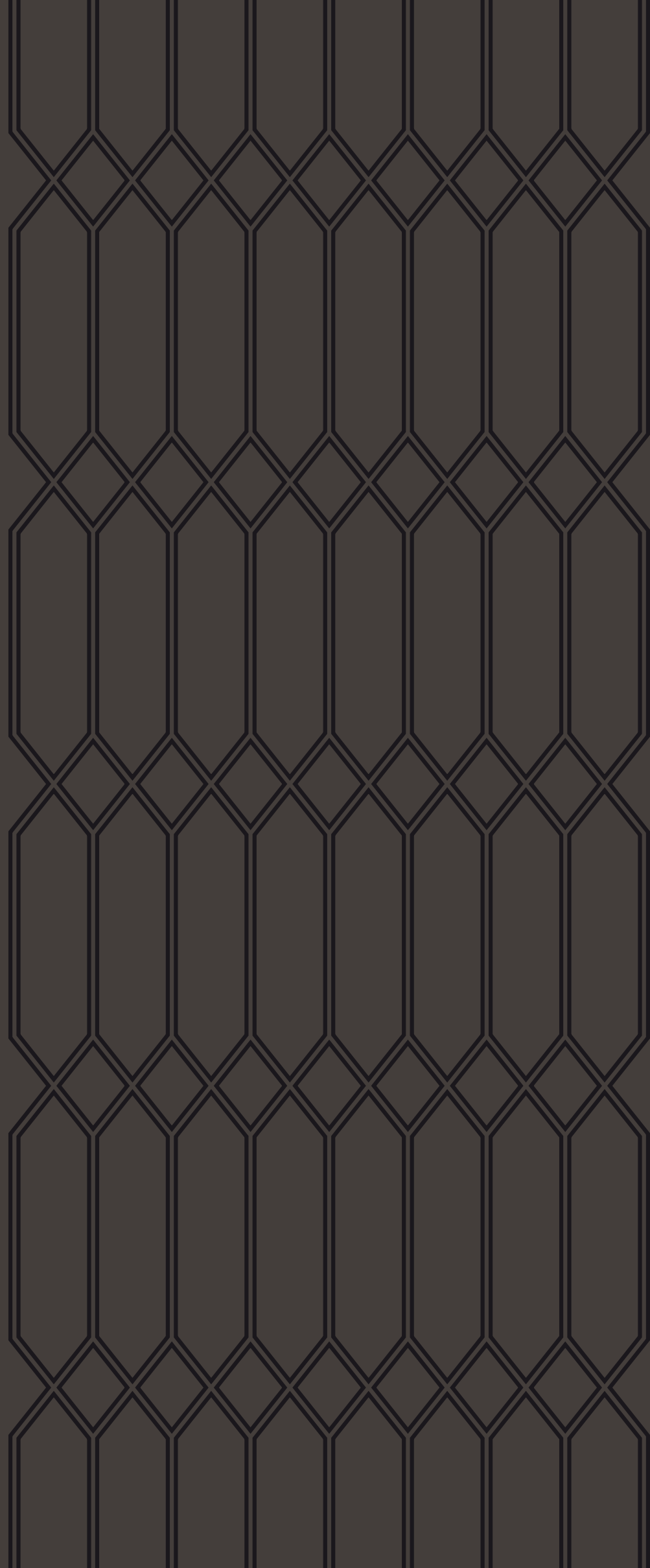

ZB

SUMMARY



SOFAS



AMAZON SOFA
Vol. 1 - pag. 22



AMBASSADOR SOFA
Vol. 1 - pag. 24



AMBASSADOR MODULAR SOFA
Vol. 1 - pag. 26



BABYLON SOFA
Vol. 1 - pag. 30



GATSBY SOFA
Vol. 1 - pag. 56



GIASONE SOFA
Vol. 1 - pag. 58



GIASONE MODULAR SOFA
Vol. 1 - pag. 61



GORDON SOFA
Vol. 1 - pag. 64



BARRYMORE SOFA
Vol. 1 - pag. 32



BARRYMORE MODULAR SOFA
Vol. 1 - pag. 34



BAUHAUS SOFA
Vol. 1 - pag. 36



BAUHAUS SOFA
Vol. 1 - pag. 38



GORDON MODULAR SOFA
Vol. 1 - pag. 67



HARMONY SOFA
Vol. 1 - pag. 70



HEMINGWAY SOFA
Vol. 1 - pag. 72



IPAZIA SOFA
Vol. 1 - pag. 74



CLUB SOFA
Vol. 1 - pag. 40



COCÒ SOFA
Vol. 1 - pag. 42



DAVIS SOFA
Vol. 1 - pag. 44



DAVIS MODULAR SOFA
Vol. 1 - pag. 46



KING SOFA
Vol. 1 - pag. 76



LEGEND SOFA
Vol. 1 - pag. 78



LEGEND SOFA
Vol. 1 - pag. 80



POSEIDON SOFA
Vol. 1 - pag. 82



EMPERADOR SOFA
Vol. 1 - pag. 48



EMPERADOR SOFA
Vol. 1 - pag. 50



FLY SOFA
Vol. 1 - pag. 52



GATSBY SOFA
Vol. 1 - pag. 54



POSEIDON SOFA
Vol. 1 - pag. 84



VERTIGO SOFA
Vol. 1 - pag. 86



VERTIGO SOFA
Vol. 1 - pag. 88



WAVE SOFA
Vol. 1 - pag. 90



WAVE MODULAR SOFA
Vol. 1 - pag. 93



CLUB WIDE ARMCHAIR
Vol. 1 - pag. 114



DAVIS ARMCHAIR
Vol. 1 - pag. 116



DAVIS SMALL ARMCHAIR
Vol. 1 - pag. 118



FLOWER ARMCHAIR
Vol. 1 - pag. 120

ARMCHAIRS



FLY ARMCHAIR
Vol. 1 - pag. 122



IPAZIA ARMCHAIR
Vol. 1 - pag. 124



IPAZIA ARMCHAIR
Vol. 1 - pag. 126



KING ARMCHAIR
Vol. 1 - pag. 128



ARDEA ARMCHAIR
Vol. 1 - pag. 98



ARDEA ARMCHAIR
Vol. 1 - pag. 100



ARIEL ARMCHAIR
Vol. 1 - pag. 102



AURORA ARMCHAIR
Vol. 1 - pag. 104



LEGEND ARMCHAIR
Vol. 1 - pag. 130



LEGEND ARMCHAIR
Vol. 1 - pag. 132



LOPEZ ARMCHAIR
Vol. 1 - pag. 134



MARYLOU ARMCHAIR
Vol. 1 - pag. 136



BAUHAUS ARMCHAIR
Vol. 1 - pag. 106



BEVERLY ARMCHAIR
Vol. 1 - pag. 108



BEVERLY ARMCHAIR
Vol. 1 - pag. 110



CLUB ARMCHAIR
Vol. 1 - pag. 112



MARYLOU ARMCHAIR
Vol. 1 - pag. 138



PANDORA ARMCHAIR
Vol. 1 - pag. 140



PANDORA ARMCHAIR
Vol. 1 - pag. 142



WALLY ARMCHAIR
Vol. 1 - pag. 144

DORMEUSE



COLETTE DORMEUSE
Vol. 1 - pag. 148



GERRIT DORMEUSE
Vol. 1 - pag. 150



GORDON DORMEUSE
Vol. 1 - pag. 152



LEGEND DORMEUSE
Vol. 1 - pag. 154

POUFS



ADAM POUF
Vol. 1 - pag. 158



BELLE POUF
Vol. 1 - pag. 159



FLY POUF
Vol. 1 - pag. 160



FLY CAPITONNÉ POUF
Vol. 1 - pag. 161



KIMBERLY POUF
Vol. 1 - pag. 162



MOON WALT POUF
Vol. 1 - pag. 163

SOFA TABLES



ALCESTE SIDE TABLE
Vol. 1 - pag. 166



CLUB CENTRAL TABLE
Vol. 1 - pag. 167



CLUB SIDE TABLE
Vol. 1 - pag. 168



DEA SIDE TABLE
Vol. 1 - pag. 169



DEA TWIN SET
Vol. 1 - pag. 170



ESEDRA SIDE TABLE
Vol. 1 - pag. 171



ESEDRA CENTRAL TABLE SET
Vol. 1 - pag. 172



EXPERIA CENTRAL TABLE
Vol. 1 - pag. 173



FLY CENTRAL TABLE
Vol. 1 - pag. 174



FLY SIDE TABLE
Vol. 1 - pag. 175



GREY TABLE SET
Vol. 1 - pag. 176



HECTOR SIDE TABLE
Vol. 1 - pag. 177



MUMFORD CENTRAL TABLE
Vol. 1 - pag. 178



MUMFORD SIDE TABLE
Vol. 1 - pag. 179



NEW LINE RECTANGULAR CENTRAL TABLE
Vol. 1 - pag. 180



NEW LINE SQUARE CENTRAL TABLE
Vol. 1 - pag. 181



NEW LINE SIDE TABLE
Vol. 1 - pag. 182



NEW LINE SIDE TABLE
Vol. 1 - pag. 183



OLIVER CENTRAL TABLE
Vol. 1 - pag. 184



OLIVER SIDE TABLE
Vol. 1 - pag. 185



TRITON ROUND TABLE 45
Vol. 1 - pag. 199



TRITON ROUND TABLE 60
Vol. 1 - pag. 200



TRITON COURTESY TABLE
Vol. 1 - pag. 201



TULIP ROUND TABLE
Vol. 1 - pag. 202



OLIVER COURTESY TABLE
Vol. 1 - pag. 186



OTTO CENTRAL TABLE
Vol. 1 - pag. 187



OTTO CENTRAL TABLE
Vol. 1 - pag. 188



RUPERT CENTRAL TABLE
Vol. 1 - pag. 189



TULIP SIDE TABLE 35+45
Vol. 1 - pag. 203



TULIP TRIS SET
Vol. 1 - pag. 204



WAVE CENTRAL TABLE
Vol. 1 - pag. 205



RUPERT CENTRAL TABLE
Vol. 1 - pag. 190



RUPERT ROUND TABLE
Vol. 1 - pag. 191



RUPERT ROUND TABLE
Vol. 1 - pag. 192



STAN CENTRAL TABLE
Vol. 1 - pag. 193



STAN COURTESY TABLE
Vol. 1 - pag. 194



STAN SIDE TABLE
Vol. 1 - pag. 195



TRITON CENTRAL TABLE
Vol. 1 - pag. 196



TRITON SQUARE TABLE
Vol. 1 - pag. 198

DINING TABLES



BOSTON RECTANGULAR DINING TABLE
Vol. 1 - pag. 208



BOSTONWIDE RECTANGULAR DINING TABLE
Vol. 1 - pag. 210



BOSTON ROUND DINING TABLE
Vol. 1 - pag. 212



GILLON EXTENSIBLE DINING TABLE
Vol. 1 - pag. 214



PETRUS RECTANGULAR DINING TABLE
Vol. 1 - pag. 240



PETRUS ROUND DINING TABLE
Vol. 1 - pag. 242



PETRUS ROUND DINING TABLE
Vol. 1 - pag. 244



WANDA RECTANGULAR DINING TABLE
Vol. 1 - pag. 246



MANHATTAN RECTANGULAR DINING TABLE
Vol. 1 - pag. 216



METROPOLIS ELLIPTICAL DINING TABLE
Vol. 1 - pag. 218



METROPOLISWIDE ELLIPTICAL DINING TABLE
Vol. 1 - pag. 220



METROPOLIS ROUND DINING TABLE
Vol. 1 - pag. 222

DINING CHAIRS



MILLENIUM ROUND DINING TABLE
Vol. 1 - pag. 224



MILLENIUM RECTANGULAR DINING TABLE
Vol. 1 - pag. 226



OMEGA CRYSTAL RECTANGULAR DINING TABLE
Vol. 1 - pag. 228



OMEGA EBONY RECTANGULAR DINING TABLE
Vol. 1 - pag. 230



ARISTON DINING CHAIR
Vol. 1 - pag. 250



ARISTON DINING CHAIR
Vol. 1 - pag. 251



CAPRICE DINING ARMCHAIR
Vol. 1 - pag. 252



CAPRICE DINING CHAIR
Vol. 1 - pag. 253



OMEGA CRYSTAL ROUND DINING TABLE
Vol. 1 - pag. 232



OMEGA EBONY ROUND DINING TABLE
Vol. 1 - pag. 234



ORION ROUND DINING TABLE
Vol. 1 - pag. 236



ORION RECTANGULAR DINING TABLE
Vol. 1 - pag. 238



CELINE DINING ARMCHAIR
Vol. 1 - pag. 254



CELINE DINING CHAIR
Vol. 1 - pag. 255



DILETTA DINING ARMCHAIR
Vol. 1 - pag. 256



DILETTA DINING ARMCHAIR
Vol. 1 - pag. 257

BAR COUNTERS AND STOOLS



DILETTA DINING CHAIR
Vol. 1 - pag. 258



DILETTA DINING CHAIR
Vol. 1 - pag. 259



GRETA DINING ARMCHAIR
Vol. 1 - pag. 260



GRETA DINING CHAIR
Vol. 1 - pag. 261



DIONISO BAR COUNTER
Vol. 1 - pag. 276



LEGEND BAR COUNTER
Vol. 1 - pag. 278



ARISTON BAR STOOL
Vol. 1 - pag. 280



FLOWER BAR STOOL
Vol. 1 - pag. 281



MARYBELL DINING ARMCHAIR
Vol. 1 - pag. 262



MARYBELL DINING ARMCHAIR
Vol. 1 - pag. 263



OPHELIA DINING ARMCHAIR
Vol. 1 - pag. 264



OPHELIA DINING ARMCHAIR
Vol. 1 - pag. 265



OPHELIA BAR STOOL
Vol. 1 - pag. 282



OPHELIA BAR TABLE
Vol. 1 - pag. 283



OPHELIA DINING CHAIR
Vol. 1 - pag. 266



OPHELIA DINING CHAIR
Vol. 1 - pag. 267



OPIUM DINING ARMCHAIR
Vol. 1 - pag. 268



OPIUM DINING CHAIR
Vol. 1 - pag. 269



SUNRISE DINING ARMCHAIR
Vol. 1 - pag. 270



SUNRISE DINING CHAIR
Vol. 1 - pag. 271



VERSAILLE DINING ARMCHAIR
Vol. 1 - pag. 272



VERSAILLE DINING CHAIR
Vol. 1 - pag. 273

BEDS



APOLLO BED
Vol. 2 - pag. 22



BERNINI BED
Vol. 2 - pag. 24



BERNINI WIDE BED
Vol. 2 - pag. 26



BERNINI XYLO BED
Vol. 2 - pag. 28



BERNINI XYLO WIDE BED
Vol. 2 - pag. 30



CLEO BED
Vol. 2 - pag. 32



HERMES BED
Vol. 2 - pag. 34



HERMITAGE BED
Vol. 2 - pag. 36



HORIZON BED
Vol. 2 - pag. 38



JUNO BED
Vol. 2 - pag. 40



KING BED
Vol. 2 - pag. 42



MADISON BED
Vol. 2 - pag. 44



OCEAN BED
Vol. 2 - pag. 46



OVERWALL BED
Vol. 2 - pag. 48

BEDSIDE TABLES



BUSTER BEDSIDE TABLE
Vol. 2 - pag. 52



CLARK BEDSIDE TABLE
Vol. 2 - pag. 53



ELYPSE BEDSIDE TABLE
Vol. 2 - pag. 54



ELYPSE BEDSIDE TABLE
Vol. 2 - pag. 55



GLENN BEDSIDE TABLE
Vol. 2 - pag. 56



HERMES BEDSIDE TABLE
Vol. 2 - pag. 57



HORIZON BEDSIDE TABLE
Vol. 2 - pag. 58



OCEAN I BEDSIDE TABLE
Vol. 2 - pag. 59



OCEAN II BEDSIDE TABLE
Vol. 2 - pag. 60



REMINGTON BEDSIDE TABLE
Vol. 2 - pag. 61



STUART BEDSIDE TABLE
Vol. 2 - pag. 62



STUART BEDSIDE TABLE
Vol. 2 - pag. 63

CHEST OF DRAWERS



BUSTER CHEST OF DRAWERS
Vol. 2 - pag. 66



BUSTER CHEST OF DRAWERS
Vol. 2 - pag. 68



DEANNA CHEST OF DRAWERS
Vol. 2 - pag. 70



GLENN CHEST OF DRAWERS
Vol. 2 - pag. 72



REMINGTON CHEST OF DRAWERS
Vol. 2 - pag. 74

DRESSING TABLES



EMANUELLE DRESSING TABLE
Vol. 2 - pag. 78



KIMBERLY DRESSING TABLE
Vol. 2 - pag. 80



KIMBERLY POUF
Vol. 2 - pag. 81



MADEMOISELLE DRESSING TABLE
Vol. 2 - pag. 82



MADEMOISELLE CHAIR
Vol. 2 - pag. 84



VIVIEN DRESSING TABLE
Vol. 2 - pag. 86



MOONWALT POUF
Vol. 2 - pag. 87

BENCHES



ADAM BENCH
Vol. 2 - pag. 90



BLANGA BENCH 100
Vol. 2 - pag. 91



BLANGA BENCH 160
Vol. 2 - pag. 92



FAYR BENCH
Vol. 2 - pag. 93



FLY BENCH
Vol. 2 - pag. 94



GREY BENCH
Vol. 2 - pag. 95



HERMES BENCH
Vol. 2 - pag. 96



MOONWALT BENCH
Vol. 2 - pag. 97

CONSOLLES



KIMBERLY CONSOLLE
Vol. 2 - pag. 100



KIMBERLY CONSOLLE SMALL
Vol. 2 - pag. 102



LUCINDA CONSOLLE
Vol. 2 - pag. 104



LUCINDA CONSOLLE
Vol. 2 - pag. 106



RANDOLPH CONSOLLE
Vol. 2 - pag. 108



SWING BACKSOFA CONSOLLE
Vol. 2 - pag. 110



SWING CONSOLLE LARGE
Vol. 2 - pag. 112



SWING CONSOLLE SMALL
Vol. 2 - pag. 114



WANDA CONSOLLE
Vol. 2 - pag. 116



WANDA CONSOLLE SMALL
Vol. 2 - pag. 118

SIDEBOARDS



CONCORDE SIDEBOARD
Vol. 2 - pag. 122



CONCORDE SIDEBOARD WIDE
Vol. 2 - pag. 124



DEANNA SIDEBOARD 9 DRAWERS
Vol. 2 - pag. 126



DEANNA SIDEBOARD 3 DRAWERS
Vol. 2 - pag. 128



DUKE SIDEBOARD
Vol. 2 - pag. 130



FIORILE SIDEBOARD
Vol. 2 - pag. 132



GLENN SIDEBOARD HIGH
Vol. 2 - pag. 134



GLENN SIDEBOARD LOW
Vol. 2 - pag. 136



REMINGTON SIDEBOARD
Vol. 2 - pag. 138

TV UNITS

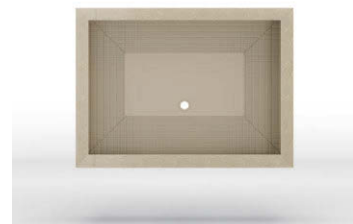

CONCORDE TV FRAME
Vol. 2 - pag. 142



CONCORDE TV CABINET
Vol. 2 - pag. 144



DUCA TV FRAME
Vol. 2 - pag. 146



DUCA TV CABINET
Vol. 2 - pag. 148



DUKE TV FRAME
Vol. 2 - pag. 150



DUKE TV CABINET
Vol. 2 - pag. 152



FIORILE TV CABINET
Vol. 2 - pag. 154



REMINGTON TV FRAME
Vol. 2 - pag. 156



REMINGTON TV CABINET
Vol. 2 - pag. 158

DISPLAY CABINETS



CONCORDE DISPLAY CABINET
Vol. 2 - pag. 162



ESTELLE DISPLAY CABINET
Vol. 2 - pag. 164



ESTELLE DISPLAY CABINET
Vol. 2 - pag. 166



FRITZ DISPLAY CABINET
Vol. 2 - pag. 168



KIMBERLY DISPLAY CABINET
Vol. 2 - pag. 170



VENUS DISPLAY CABINET
Vol. 2 - pag. 172

BOOKSHELVES



CLARK BOOKSHELF
Vol. 2 - pag. 176



DAFNE BOOKSHELF
Vol. 2 - pag. 178



JADE BOOKSHELF
Vol. 2 - pag. 180



SIRIO BOOKSHELF
Vol. 2 - pag. 182

CABINETS



CONCORDE WARDROBE CABINET
Vol. 2 - pag. 186



CONCORDE WINE CABINET
Vol. 2 - pag. 188



DEDALO BACK SOFA CABINET
Vol. 2 - pag. 191



DEDALO CABINET
Vol. 2 - pag. 192



RICHELIEU BAR CABINET
Vol. 2 - pag. 206



RICHELIEU GAMING CABINET
Vol. 2 - pag. 208



VENUS CABINET
Vol. 2 - pag. 210



DEDALO DUAL UNIT
Vol. 2 - pag. 193



DEDALO FREE STANDING PARTITION 1
Vol. 2 - pag. 194



DEDALO FREE STANDING PARTITION 2
Vol. 2 - pag. 195



DEDALO LIBRARY
Vol. 2 - pag. 196

DESKS



DEDALO OFFICE COMPOSITION
Vol. 2 - pag. 197



DEDALO SIDEBOARD
Vol. 2 - pag. 198



DEDALO TV CABINET 1
Vol. 2 - pag. 199



DEDALO TV COMPOSITION 1
Vol. 2 - pag. 200



ASTORIA DESK
Vol. 2 - pag. 214



CLARK DESK
Vol. 2 - pag. 216



LEGEND DESK
Vol. 2 - pag. 218



SQUARE DESK
Vol. 2 - pag. 220



DEDALO TV COMPOSITION 2
Vol. 2 - pag. 201



DEDALO TV COMPOSITION 3
Vol. 2 - pag. 202



DEDALO WALL COMPOSITION
Vol. 2 - pag. 203



FRITZ BAR CABINET
Vol. 2 - pag. 204

OFFICE CHAIRS



ATLANTIS OFFICE CHAIR
Vol. 2 - pag. 224



COMET FRONT DESK CHAIR
Vol. 2 - pag. 225



COMET OFFICE CHAIR
Vol. 2 - pag. 226



LONDON OFFICE CHAIR
Vol. 2 - pag. 227



REGENT FRONT DESK CHAIR
Vol. 2 - pag. 228



REGENT OFFICE CHAIR
Vol. 2 - pag. 229

MIRRORS

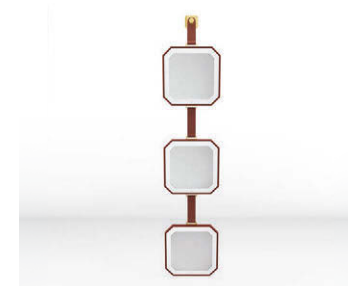

ARTEMIDE MIRROR
Vol. 2 - pag. 232



CONSTANCE MIRROR
Vol. 2 - pag. 233



ETIENNE MIRROR
Vol. 2 - pag. 234

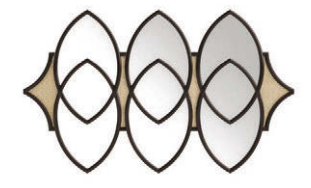

FLYNN MIRROR
Vol. 2 - pag. 235



IKE MIRROR
Vol. 2 - pag. 236



JUPITER MIRROR
Vol. 2 - pag. 237



OSIRIS RECTANGULAR MIRROR
Vol. 2 - pag. 238



OSIRIS ROUND MIRROR
Vol. 2 - pag. 239



SHIRLEY MIRROR
Vol. 2 - pag. 240



TWIN MIRROR
Vol. 2 - pag. 241



TWIN MIRRORS COMPOSITION 1
Vol. 2 - pag. 242



TWIN MIRRORS COMPOSITION 2
Vol. 2 - pag. 243

DECORATIONS



ARES PANELING
Vol. 2 - pag. 246



BAUHAUS COLUMN
Vol. 2 - pag. 248



CLUB COLUMN
Vol. 2 - pag. 249



EOLO SAIL
Vol. 2 - pag. 250



LEONE WOOD SCREEN
Vol. 2 - pag. 252



ODISSEY SCREEN
Vol. 2 - pag. 254

RUGS



AMBASSADOR RUG
Vol. 2 - pag. 258



ASTORIA RUG
Vol. 2 - pag. 259



CLUB CARVED RUG
Vol. 2 - pag. 260



OCEAN RUG
Vol. 2 - pag. 261



PETRUS RUG
Vol. 2 - pag. 262

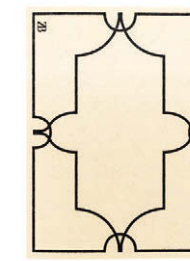

SHIRLEY RUG
Vol. 2 - pag. 263



VERTIGO RUG
Vol. 2 - pag. 264



WAVE RUG
Vol. 2 - pag. 265

LIGHTINGS



ASTORIA TABLE LAMP
Vol. 2 - pag. 268



ASTORIA WALL LAMP
Vol. 2 - pag. 269



BERNINI TABLE LAMP
Vol. 2 - pag. 270



TWIN CHANDELIER
Vol. 2 - pag. 271



TWIN RECTANGULAR CHANDELIER
Vol. 2 - pag. 272



TWIN SUSPENSION LAMP
Vol. 2 - pag. 273



TWIN STANDING LAMP
Vol. 2 - pag. 274



TWIN TABLE LAMP
Vol. 2 - pag. 275



TWIN WALL LAMP
Vol. 2 - pag. 276



WAVE STANDING LAMP
Vol. 2 - pag. 277



WAVE TABLE LAMP
Vol. 2 - pag. 278

CONTACT US

BRUNO ZAMPA s.r.l.

Via Crosaron, 23
37053 Cerea
Verona - Italy
T. +39 0442 80594
F. +39 0442 329534

GALLERY

Via Calcara, 68/70
37053 Cerea
Verona - Italy

info@brunozampa.it
www.brunozampa.it

Produced by
©Bruno Zampa s.r.l. - All rights reserved

PHOTO Lighthug Design s.r.l. and Place Design e Rendering s.r.l.s.

GRAPHIC DESIGN Deepartweb s.r.l.

PRINTING Grafiche Stella s.r.l.

All products in this catalogue are 100% Made in Italy.

All colors of leather or fabric's covers, lacquered wood and rugs can't be considered as color references.

The dimensions of products are subject to change according to the instructions of the catalogue.

Any reproduction, representation or modification, in full or partly, is expressly prohibited.



www.brunozampa.it